

**INTRODUCING**  
SOULMATE

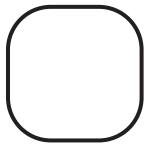

Square

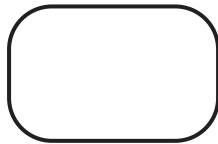

Rectangle

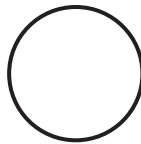

Circle

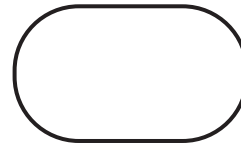

Oval

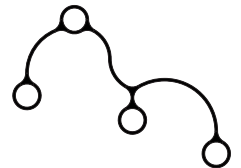

Free Pattern

**SOULMATE Infinity Shapes** — is a versatile Free-Form Shape LED luminaire that brings spirit, energy, and action to large space environments by harnessing the flexibility and creativity of a tapelight while maintaining the quality and durability of a solid luminaire. Designed to simultaneously enhance creativity and functionality in a space, SOULMATE helps create intricate, sprawling shapes by connecting rounded-edge SOUL shapes with curved joiners, elevating the versatility, flexibility, and creativity of SOUL luminaires to new heights.

Available with surface mount, ceiling mount, recessed trimless mount, and wall mounting options, in a standard width of 2.3", in various lengths and angles that allow for playful design. Capable of max. continuous runs of 8 feet and ideal for adding an element of originality to corporate offices, educational, commercial, and retail spaces.

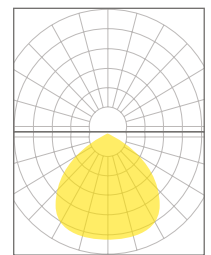
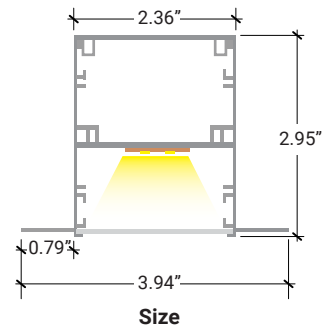

Light Distribution

### OPTICS & PERFORMANCE

This item's high-efficiency LED optical system includes a precision-cut acrylic lens with a smooth frosted finish for glare-free, even illumination and reflective sidewalls that help distribute the LED light evenly across the acrylic-surface. The lens features a snap-in design that fits securely into the groove of the fixture's body, making it easy to remove for access to the LED driver and LED board. This SOUL-LED fixture can be customized into various shapes by assembling different angles and degrees to meet diverse architectural needs.

### CONSTRUCTION

Body constructed from up to 90% recyclable, extruded architectural-grade 6063 aluminum with a minimum wall thickness of 0.075", to ensure durability and sustainability. Lenses are made from twin-layered, extruded high-impact acrylic, with a maximum single length of 8 ft.

### DISTRIBUTION PATTERNS & DIFFUSER

Features an optically extruded, high-impact acrylic lens for a uniform, smooth illumination with reduced glare and precise light output control. Lens designed to snap securely into the housing and integrate seamlessly with the fixture, to ensure a refined and clean appearance.

### CRM INSTALLATION

Lighting design will adhere to the factory shop drawing. For continuous mounting, the first section will always include the power supply feed. Housing connections will feature a joint bracket and a male/female connector for electrical connections. For special mounting requirements, please follow the provided mounting instructions.

### RECESSED TRIMLESS MOUNT

Designed for installation on drywall. Not compatible with T-bar or suspended (drop) ceilings.

For trimless recessed mounting, make a precise cutout that matches the shape and size of the fixture. Secure the integrated flanges of the luminaire directly to the ceiling structure with screws, ensuring proper alignment and support. Wire each segment before installing the next for easier handling, and follow the installation and wiring diagrams provided with the custom factory drawings.

After the fixture is secured, apply plaster or joint compound over the flanges and finish the ceiling surface to achieve a seamless, trimless appearance.

Floor mounting is available for decorative purposes only. Please consult factory for additional information.

### LED DYNAMIC PLATFORM OPTIONS

Tunable White with Smart White Technology allows for color tuning of the luminaire via various controls. Use Tuneable White to mimic daytime light signals that affect circadian rhythm, aid in sleep, mood, and general well-being while creating perfect custom spaces. Maintains a CRI of 90+ across the tunable range of 6500 to 2700K.

### DIMMING & DRIVER INFORMATION

**DIM10** - 0-10V dimming on either MVOLT 120, 277. Dimmable down to 1% of initial lumens, standard.

**ELDO10.1** - E IdoLED SoloDrive 0-10V. Dimming down to 0.1%. Linear dimming curve.

**EldoDALI** - DALI DT6, DT8 dimming down to 1%.

**ELDODMX.1** - EldoLED PowerDrive dimming down to 0.1%.

**BLE** - Luminaires may be controlled, grouped, scheduled or placed in scenes and or zones Via Cassambi Bluetooth 4.0 App

### FINISH

Standard color - White / Black / Anodized aluminum.  
RAL CLASSIC COLORS.

### WARRANTY

Five-year warranty for parts and components.(Labor not included).

### LISTINGS

**cETLus** - Listed

**RoHs** - Contains no mercury or lead and RoHS compliant

### TECHNICAL DETAILS



|                           |  |
|---------------------------|--|
| <b>INPUT VOLTAGE</b>      | 120-277V   |
| <b>POWER</b>              | 6W/ft, 9W/ft   |
| <b>EFFICIENCY LM/W</b>    | 100Lm/W  |
| <b>LUMENS PER FOOT</b>    | 650L, 900L   |
| <b>CRI</b>                | 90+, 95+   |
| <b>LIGHT DISTRIBUTION</b> | Direct   |
| <b>CCT</b>                | 6500K - 2700K  |
| <b>SHAPES</b>             | Square, Rectangle, Circle, Oval, and Free-form Pattern |

|                               |   |
|-------------------------------|---|
| <b>MOUNTING</b>               | Recessed Trimless Mount   |
| <b>SIZE</b>                   | W 2.36" x H 2.95" (3.94" flange-to-flange)                                    |
| <b>CURVE DEGREES</b>          | 30°, 45°, 60°, 90°, 120° Custom Degrees Available                             |
| <b>CURVE RADIUS</b>           | 24", 36", 48", 60", 72", 84" Custom Radius Available                          |
| <b>CONTINUOUS LENGTHS</b>     | 2 ft, 4 ft, 6 ft, 8 ft Custom Lengths Available.                              |
| <b>COLOR</b>                  | White, Black, Silver, Custom RAL  |
| <b>DIMMING &amp; CONTROLS</b> | 0-10V Flicker Free 1% Dimming (DIM10), ELDO10.1-, ELDODMX.1, ELDODALI.1, BLE. |
| <b>EMERGENCY</b>              | Remote Emergency Option. Consult Factory                                      |

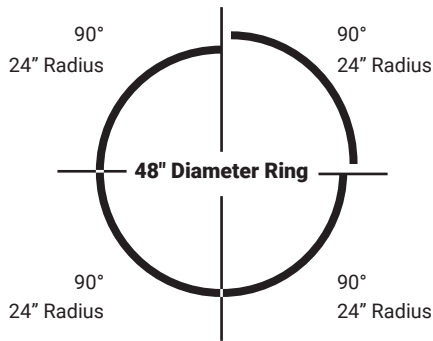

**Ring Diameters**

Made by individual segments

**Radius of Each Segment:** There are four, 90-degree segments, each with a radius of 24 inches.

**Complete Circle:** Four 90-degree segments come together to form a complete circle (360 degrees).

**Diameter Calculation:** The diameter of a circle is twice the radius. So, with a radius of 24 inches:

**Diameter**= 2×Radius=2×24=48inches

The diameter of the fixture ring is 48 inches.

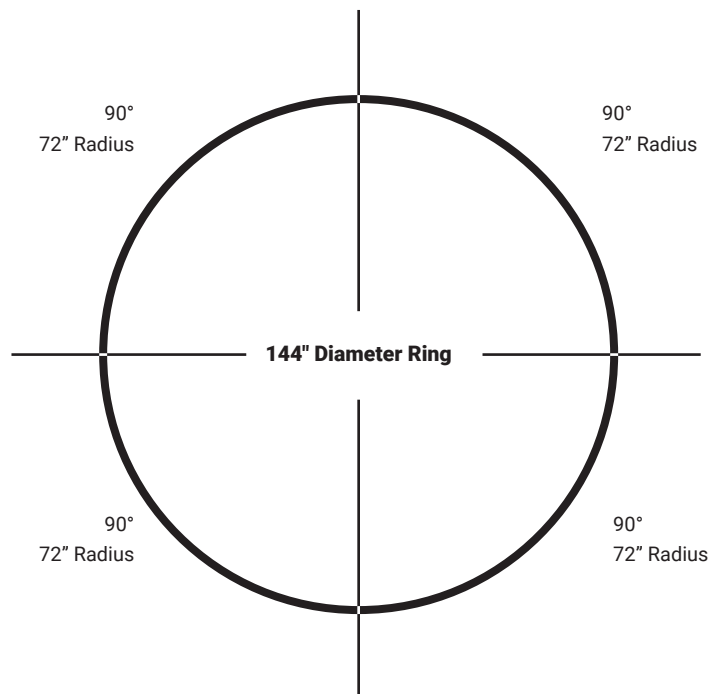
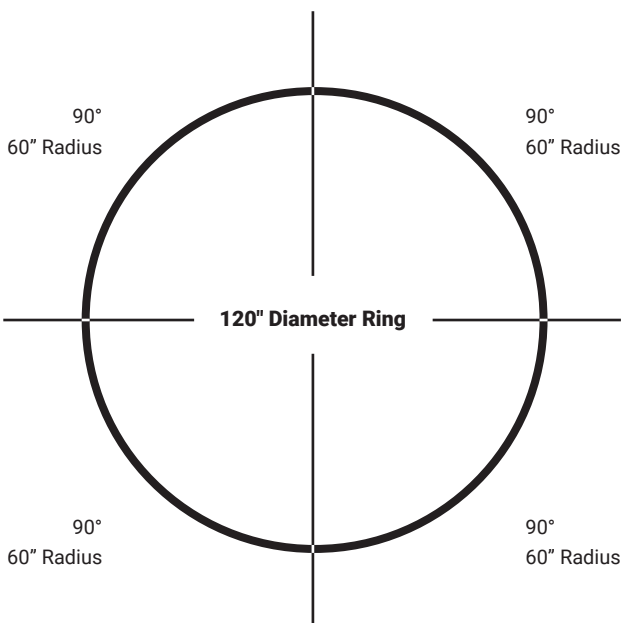
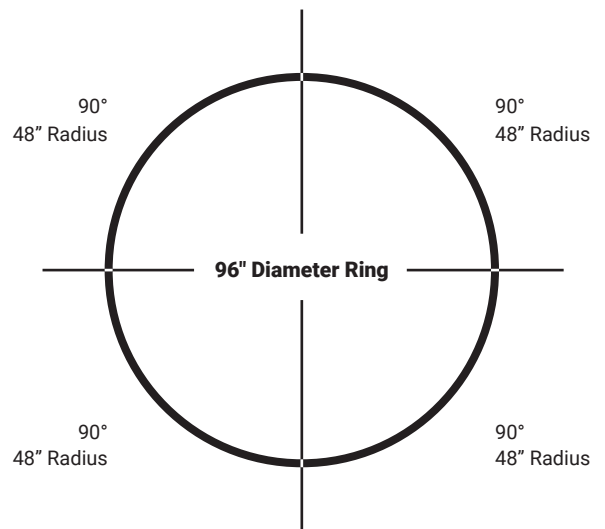
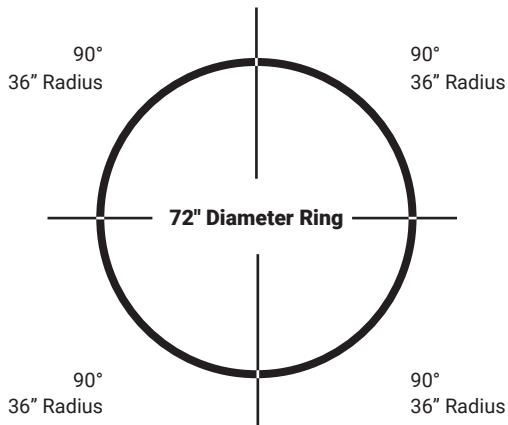

**30 Degrees** Custom radii and degrees available

**Part# 30SOUL-R24**

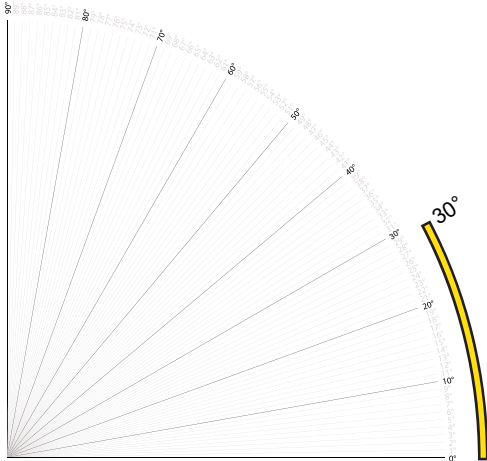
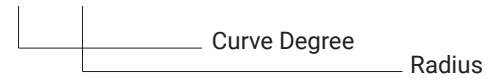

**30 Degrees**

A. Curve length / B. Chord Length / C. Radius

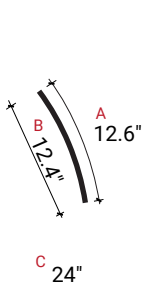

**30SOUL-R24**

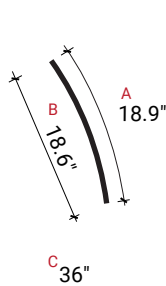

**30SOUL-R36**

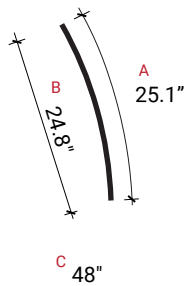

**30SOUL-R48**

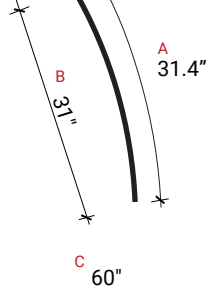

**30SOUL-R60**

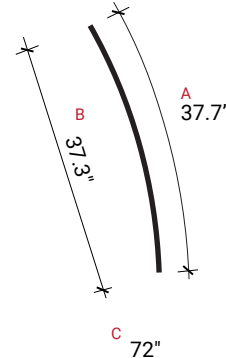

**30SOUL-R72**

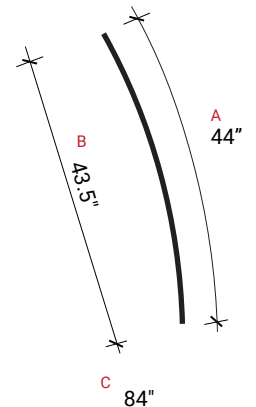

**30SOUL-R84**

**45 Degrees** Custom radii and degrees available

**Part# 45SOUL-R24**

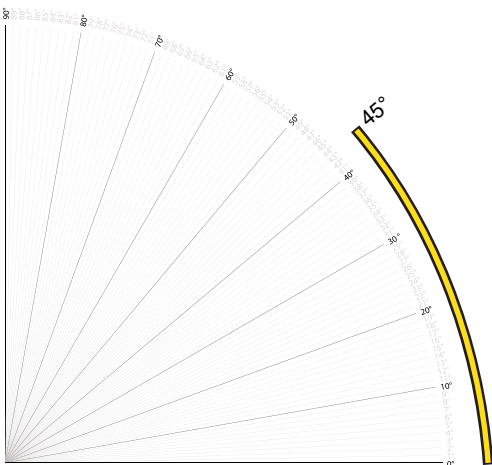
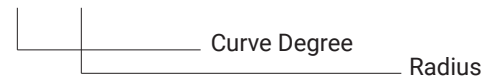

**45 Degrees**

A. Curve length / B. Chord Length / C. Radius

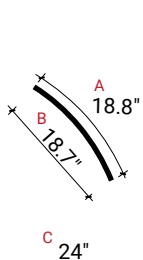

**45SOUL-R24**

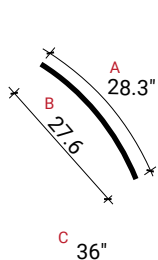

**45SOUL-R36**

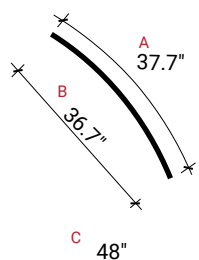

**45SOUL-R48**

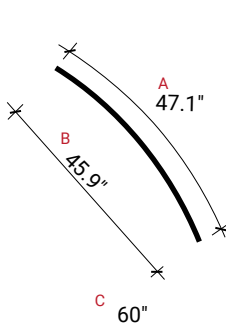

**45SOUL-R60**

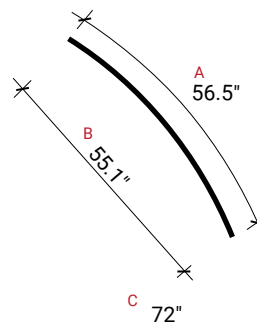

**45SOUL-R72**

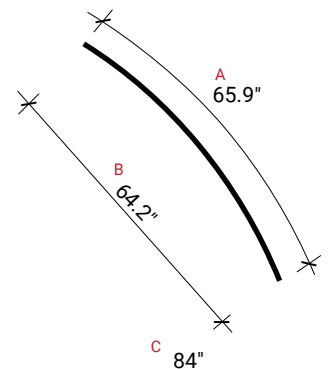

**45SOUL-R84**

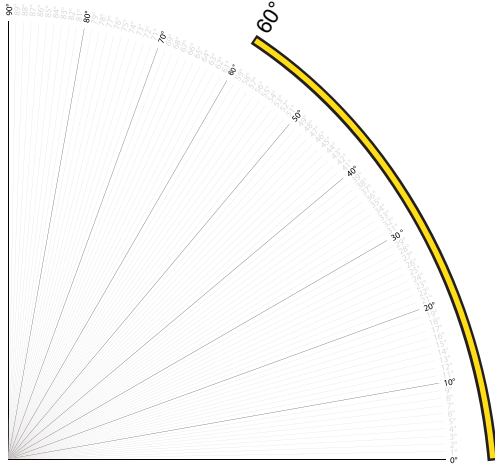

**60 Degrees**  
A. Curve length / B. Chord Length / C. Radius

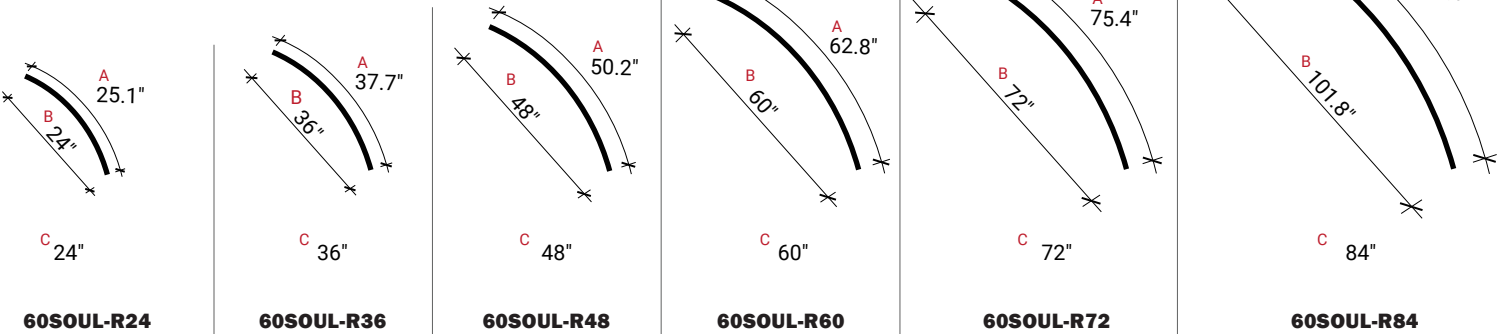

**60 Degrees** Custom radii and degrees available

Part# 60Soul-R24

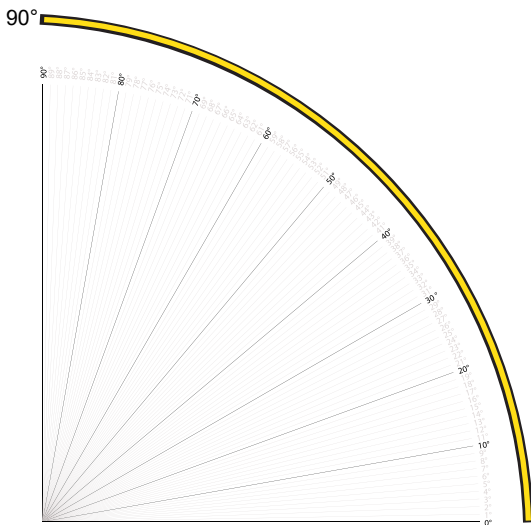
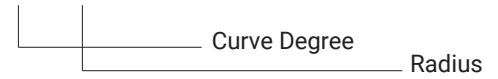

**90 Degrees**  
A. Curve length / B. Chord Length / C. Radius

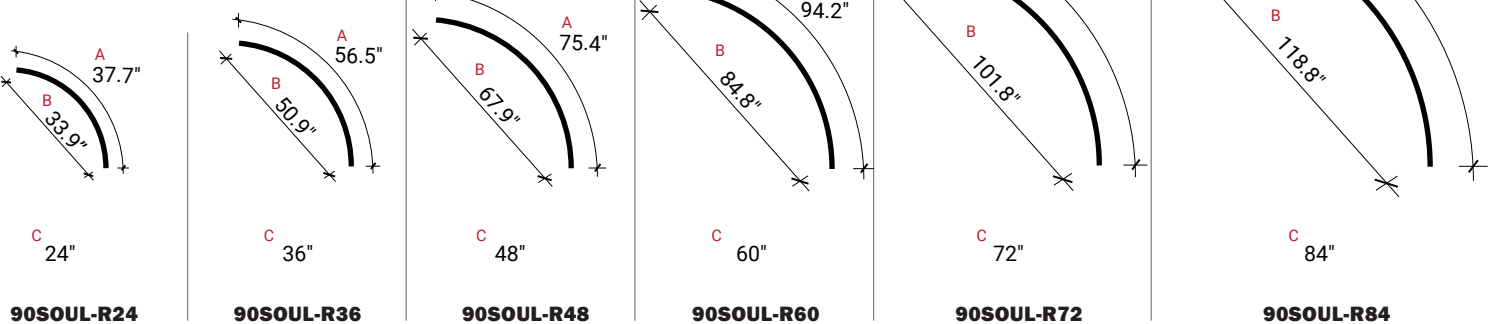

**90 Degrees** Custom radii and degrees available

Part# 90Soul-R24

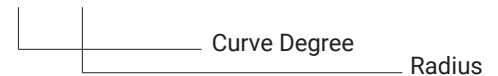

**120 Degrees** Custom radii and degrees available

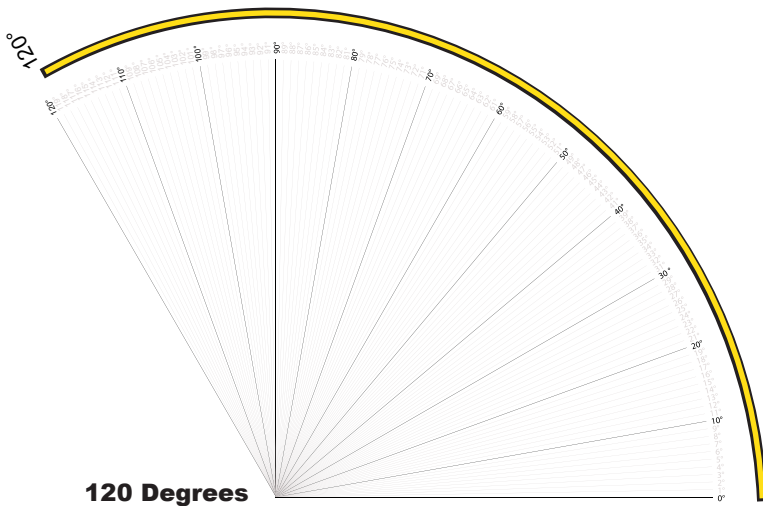

**Part# 120SOUL-R24**

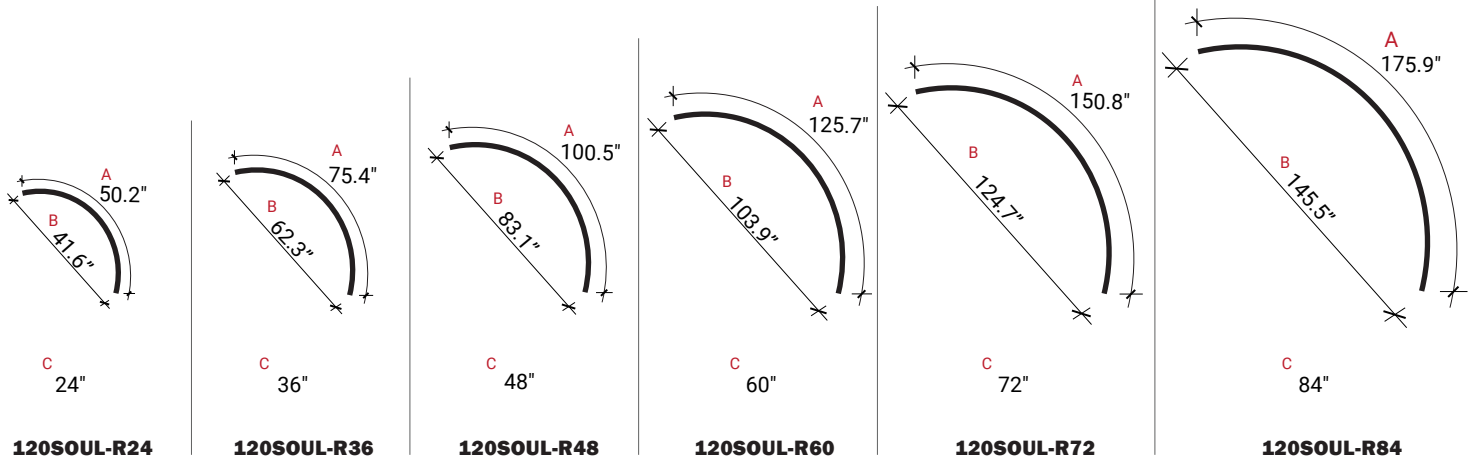
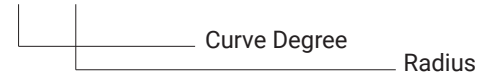

**Straight Runs**

Custom straight runs are available in increments of 1 inch

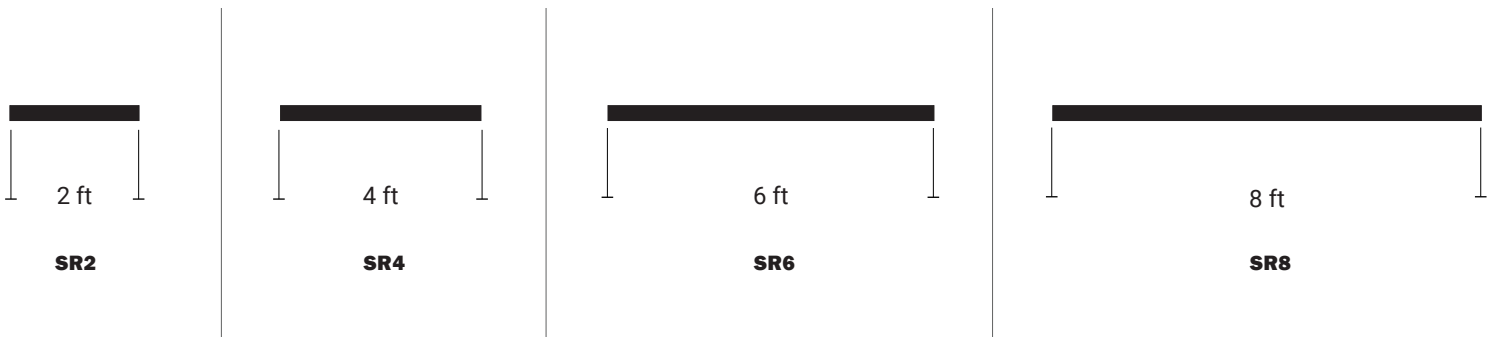

**Curved Joiners**

Curved joiners are essential for connecting arcs, curves, and continuous lengths. These joiners facilitate the creation of a variety of shapes with a rounded finish.

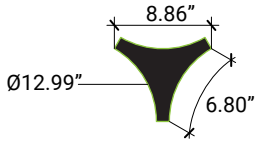

**JY-SOUL1**  
Y-Shaped Joiner

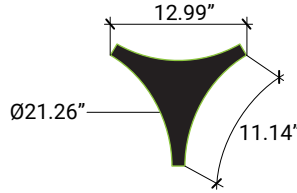

**JY-SOUL2**  
Y-Shaped Joiner

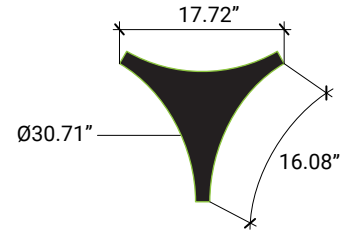

**JY-SOUL3**  
Y-Shaped Joiner

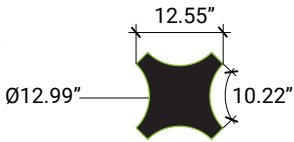

**JX-SOUL1**  
X-Shaped Joiner

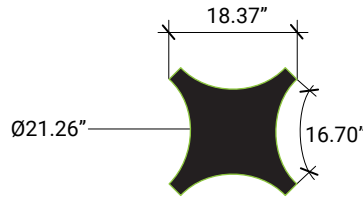

**JX-SOUL2**  
X-Shaped Joiner

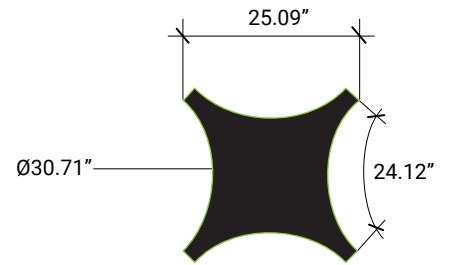

**JX-SOUL3**  
X-Shaped Joiner

**Samples**

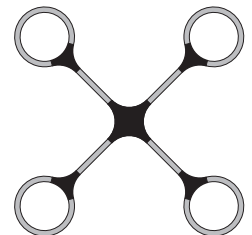
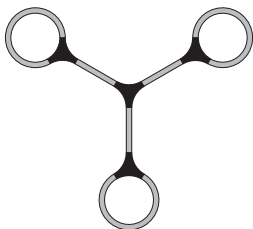



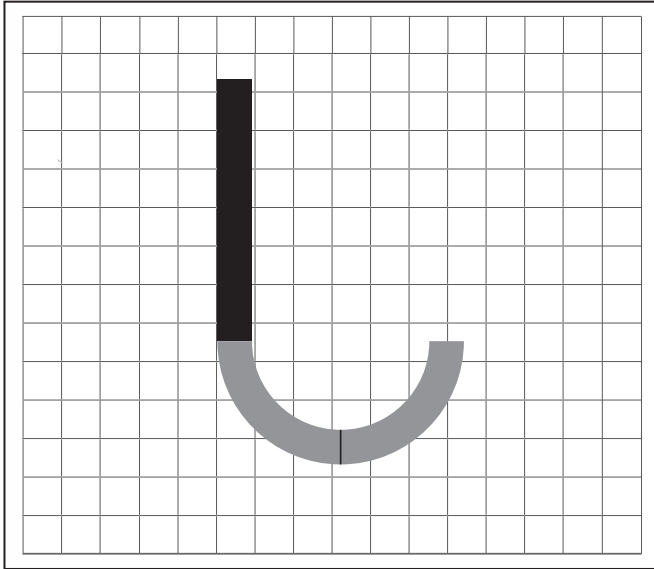

## How to **design** **your** OWN shapes!

1. Select the pieces you want to use to build the fixture and draw them on the grid. Refer to pages 4, 5, 6, and 7 to choose the desired pieces.
2. After drawing the fixture on the grid, send the design to [yuchen@iuseelite.com](mailto:yuchen@iuseelite.com)
3. Once you approve the design, we will bring it to life.

## PRACTICE!

Take a look at pages 4, 5, 6, and 7 and see if you can figure out which parts were used to assemble this luminaire.

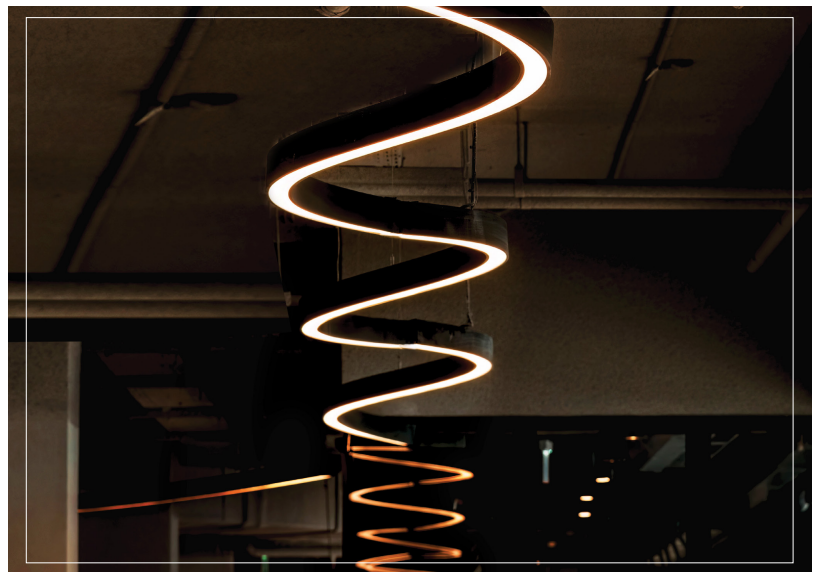
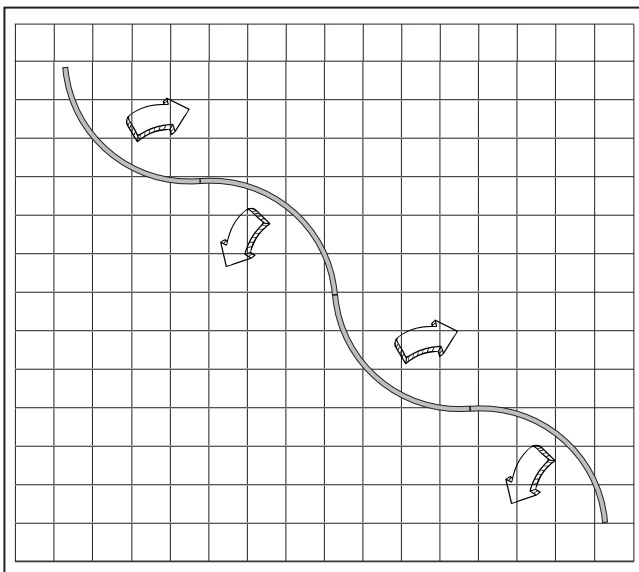

Image shown: Suspended wave luminaire. Wave shapes can also be installed as recessed mounts.

Curve Radius Part# \_\_\_\_\_

Straight Runs Part# \_\_\_\_\_

**Luminaire Configuration Guide**

**SR—Straight Runs:**

2 ft, 4 ft, 6 ft, 8 ft, Custom

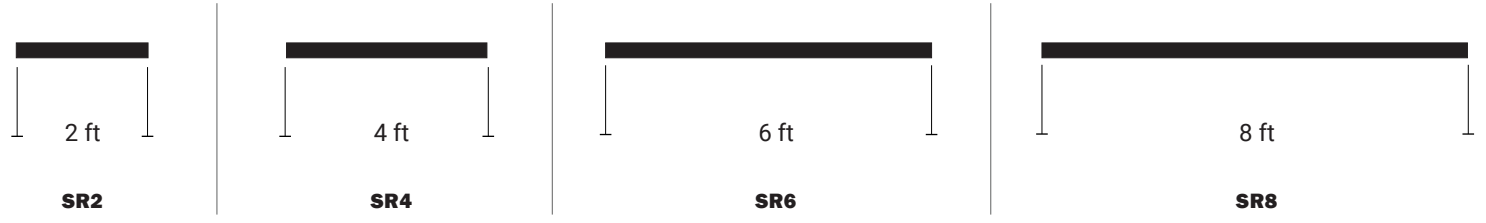

**DC—DEGREE OF CURVE:**

30°, 45°, 60°, 90°, 120°, Custom

**R—CURVE RADIUS:**

24", 36", 48", 60", 72", 84", Custom

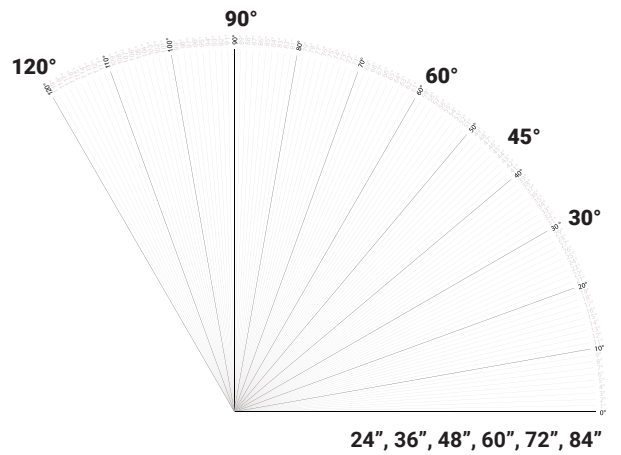

**Be Inspired**

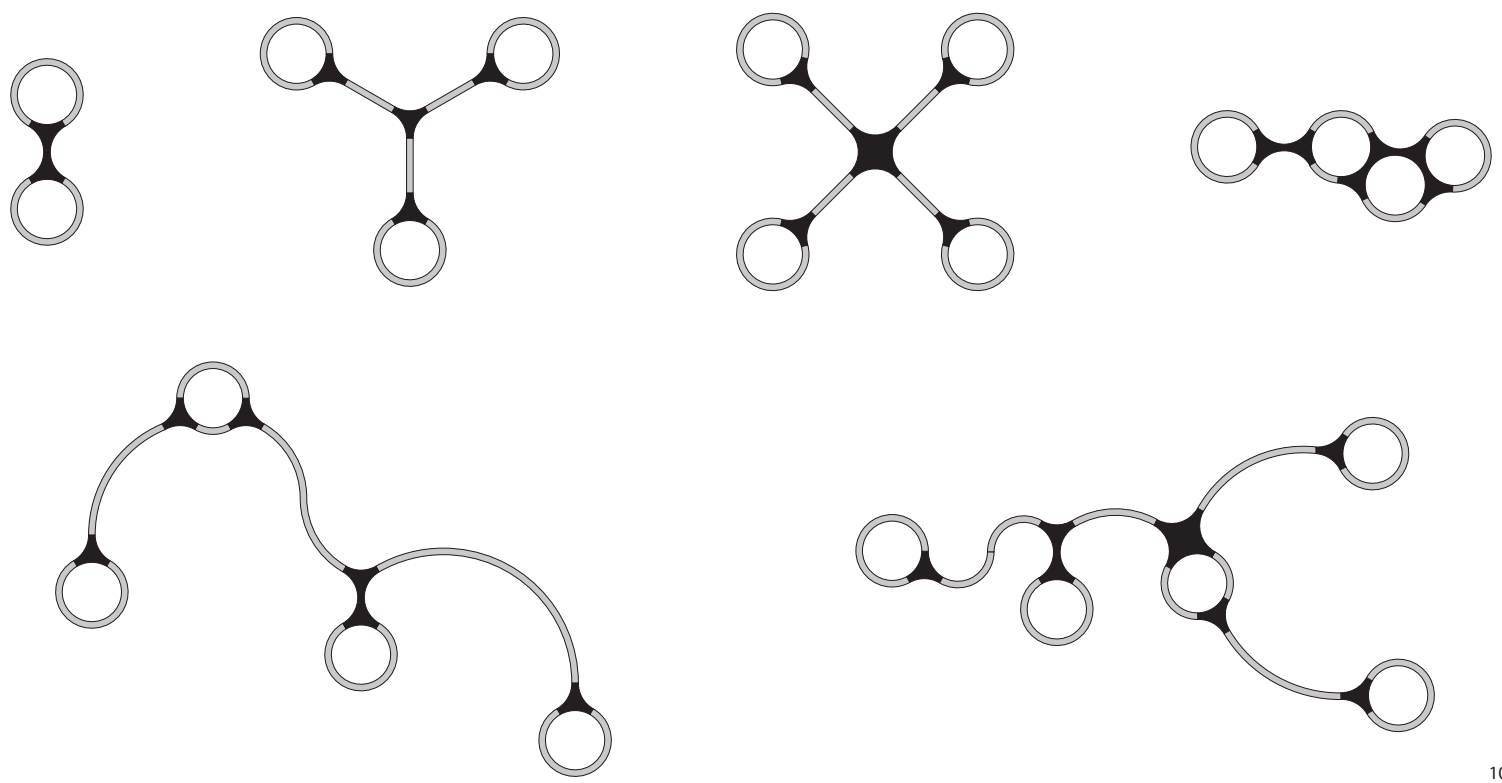

**ORDERING TABLE**

Example: SOULMATE-TWH-RTM-2-CUS-D650L-1C-REM-DIM10-MVOLT-6500K-2700K-95-WH

| SERIES           | SIZE                         | <sup>2</sup> SHAPE  | LUMENS / DIRECT  | DISTRIBUTION       | NUMBER OF CIRCUITS |
|------------------|------------------------------|---|--|--------------------|--------------------|
| SOULMATE-TWH-RTM | <sup>1</sup> 2 - 2.36"x2.95" | CUS - Custom<br><i>Sketch your design on the next page.</i> | D650L - 650 Lumens Per Ft<br>D900L - 900 Lumens Per Ft | (blank) - Standard | 1C<br>2C           |

| DRIVER MOUNT        | DIMMING  | VOLTAGE          | CCT           | CRI                      | FINISH   |
|---------------------|--|------------------|---------------|--------------------------|--|
| REM - Remote Driver | DIM10 - 0-10V Dimming<br>ELDO10.1 - ELDO 0-10V<br>ELDODMX.1 - EldoLED DMX<br>ELDODALI.1 - ELDODALI.1<br>BLE - Wireless Bluetooth Control | MVOLT - 120-277V | 6500K - 2700K | 90 - 90CRI<br>95 - 95CRI | WH - White<br>BK - Black<br>SI - Silver<br>RAL - Consult Factory |

| <sup>3</sup> EMERGENCY                 | TOTAL RUN / FT & IN  |
|--|--|
| REM-0-EMG-LED-10W<br>REM-0-EMG-LED-20W | XX.YY.ZZ<br>XX= Length in Feet<br>YY= Fraction in Inches<br>ZZ= Fractions of an Inch<br>e.g. 22 ft. 6 in. 1/2 in |

1. W 2.36" × H 2.95" (3.94" flange-to-flange)

2. Please refer to the next page and sketch your design on the grid. Afterward, email it to [yuchen@iuseelite.com](mailto:yuchen@iuseelite.com) with any required details

3. Remote emergency option available, please consult factory



Sketch your design using the grid space below and email it to [yuchen@iuseelite.com](mailto:yuchen@iuseelite.com)



Square



Rectangle



Ring

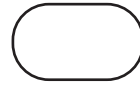

Oval

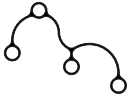

Free Pattern