



Tunable White



FLICKER FREE

RoHS

INTRODUCING

SOULMATE

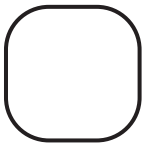

Square

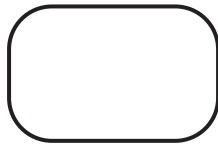

Rectangle

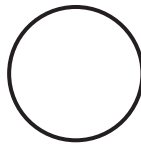

Circle

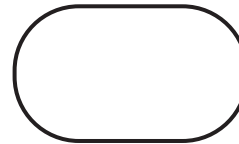

Oval

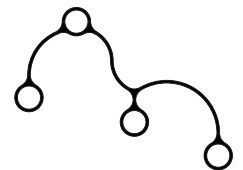

Free Pattern

SOULMATE Infinity Shapes — is a versatile Free-Form Shape LED luminaire that brings spirit, energy, and action to large space environments by harnessing the flexibility and creativity of a tapelight while maintaining the quality and durability of a solid luminaire. Designed to simultaneously enhance creativity and functionality in a space, SOULMATE helps create intricate, sprawling shapes by connecting rounded-edge SOUL shapes with curved joiners, elevating the versatility, flexibility, and creativity of SOUL luminaires to new heights.

Available with surface and wall mounting options, in a standard width of 2.3", in various lengths and angles that allow for playful design. Capable of max. continuous runs of 8 feet and ideal for adding an element of originality to corporate offices, educational, commercial, and retail spaces.

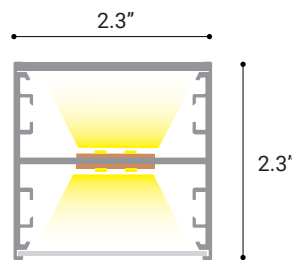

Size

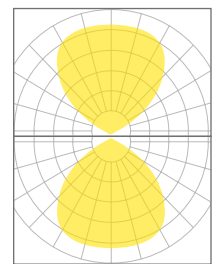

Ligth Distribution

OPTICS & PERFORMANCE

This item's high-efficiency LED optical system includes a precision-cut acrylic lens with a smooth frosted finish for glare-free, even illumination and reflective sidewalls that help distribute the LED light evenly across the acrylic-surface. The lens features a snap-in design that fits securely into the groove of the fixture's body, making it easy to remove for access to the LED driver and LED board. This SOUL-LED fixture can be customized into various shapes by assembling different angles and degrees to meet diverse architectural needs.

CONSTRUCTION

Body constructed from up to 90% recyclable, extruded architectural-grade 6063 aluminum with a minimum wall thickness of 0.075", to ensure durability and sustainability. Lenses are made from twin-layered, extruded high-impact acrylic, with a maximum single length of 8 ft.

DISTRIBUTION PATTERNS & DIFFUSER

The optically extruded, high-impact acrylic lens provides uniform, smooth illumination with reduced glare and precise control of light output. It is designed to snap securely into the housing and integrate seamlessly with the fixture, ensuring a refined and clean appearance.

CRM INSTALLATION

Lighting design will adhere to the factory shop drawing. For continuous mounting, the first section will always include the power supply feed. Housing connections will feature a joint bracket and a male/female connector for electrical connections. For special mounting requirements, please follow the provided mounting instructions.

SUPPORT CABLE/FEED

For the suspended mount version of SOULMATE Infinity Shapes, aircraft cable mounting points are available at intervals of 2, 4, 6, 8, and 11 feet centered along the fixture's length, with the mounting points positioned a 1/2 inch from each end of the fixture or run. Adjustable cable mounts can be made to align with the existing mounting points, as per the installation instructions, and allow for adjustment across the fixture's width for balance.

The minimum suspension height from the ceiling to the top of the fixture is one and a half feet, to avoid shadows on the ceiling. All sections come pre-wired with push-in connectors for quick setup, and the fixtures can be connected in a straight, continuous run using the supplied alignment brackets, pins, and internal joiners.

LED DYNAMIC PLATFORM OPTIONS

Tunable White with Smart White Technology allows for color tuning of the luminaire via various controls. Use Tuneable White to mimic daytime light signals that affect circadian rhythm, aid in sleep, mood, and general well-being while creating perfect custom spaces. Maintains a CRI of 90+ across the tunable range of 6500 to 2700K.

DIMMING & DRIVER INFORMATION

DIM10 - 0-10V dimming on either MVOLT 120, 277. Dimmable down to 1% of initial lumens, standard.

ELDO10.1 - E ldoLED SoloDrive 0-10V. Dimming down to 0.1%. Linear dimming curve.

EldoDALI - DALI DT6, DT8 dimming down to 1%.

ELDODMX.1 - EldoLED PowerDrive dimming down to 0.1%.

BLE - Luminaires may be controlled, grouped, scheduled or placed in scenes and or zones Via Cassambi Bluetooth 4.0 App

FINISH

Standard color - White / Black / Anodized aluminum.
RAL CLASSIC COLORS.

WARRANTY

Five-year warranty for parts and components.(Labor not included).

LISTINGS

cETLus - Listed

RoHS - Contains no mercury or lead and RoHS compliant

TECHNICAL DETAILS



INPUT VOLTAGE	120-277V
POWER	Downlight 6W/ft, 9W/ft - Uplight 3W/ft, 4.5W/ft
EFFICIENCY LM/W	100Lm/W
LUMENS PER FOOT	Downlight 650L, 900L - Uplight 300L, 450L
CRI	90+, 95+
LIGHT DISTRIBUTION	Direct - Indirect
CCT	6500K - 2700K
SHAPES	Square, Rectangle, Circle, Oval, and Free-form Pattern

MOUNTING	Suspended Mount
SIZE	W2.3" x H2.3"
CURVE DEGREES	30°, 45°, 60°, 90°, 120° Custom Degrees Available
CURVE RADIUS	24", 36", 48", 60", 72", 84" Custom Radius Available
CONTINUOUS LENGTHS	2 ft, 4 ft, 6 ft, 8 ft Custom Lengths Available.
COLOR	White, Black, Silver, Custom RAL
DIMMING & CONTROLS	0-10V Flicker Free 1% Dimming (DIM10), ELDO10.1-, ELDODMX.1, ELDODALI.1, BLE.
EMERGENCY	Remote Emergency Option. Consult Factory

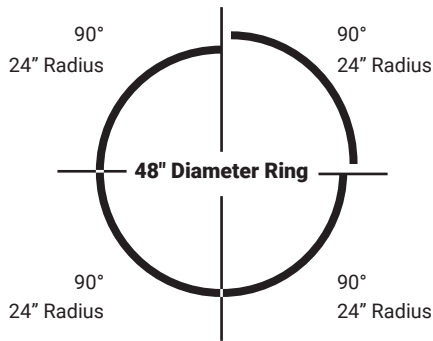

Ring Diameters

Made by individual segments

Radius of Each Segment: There are four, 90-degree segments, each with a radius of 24 inches.

Complete Circle: Four 90-degree segments come together to form a complete circle (360 degrees).

Diameter Calculation: The diameter of a circle is twice the radius. So, with a radius of 24 inches:

Diameter= 2×Radius=2×24=48inches

The diameter of the fixture ring is 48 inches.

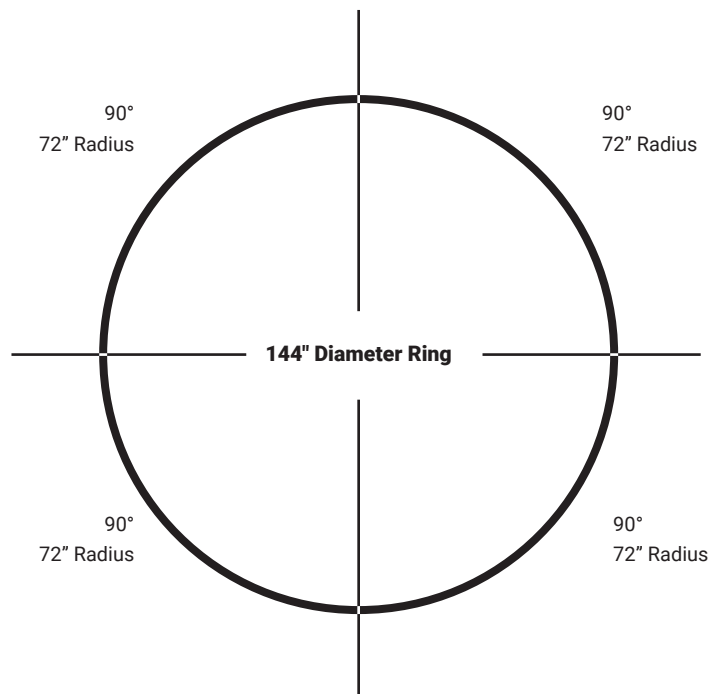
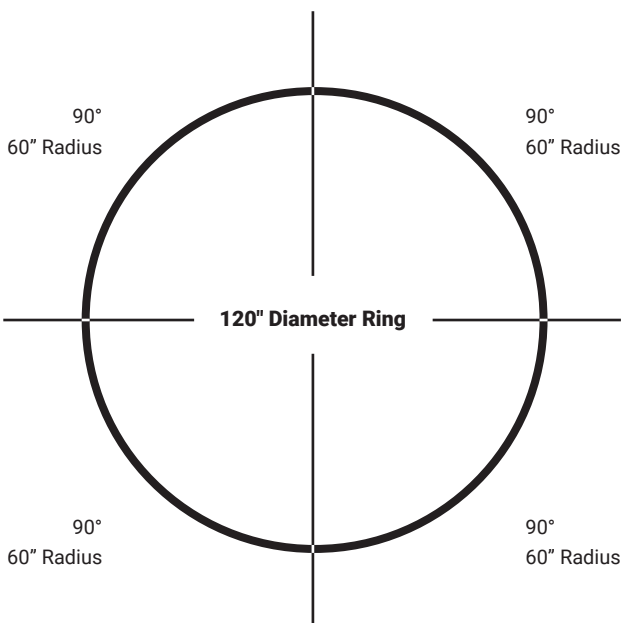
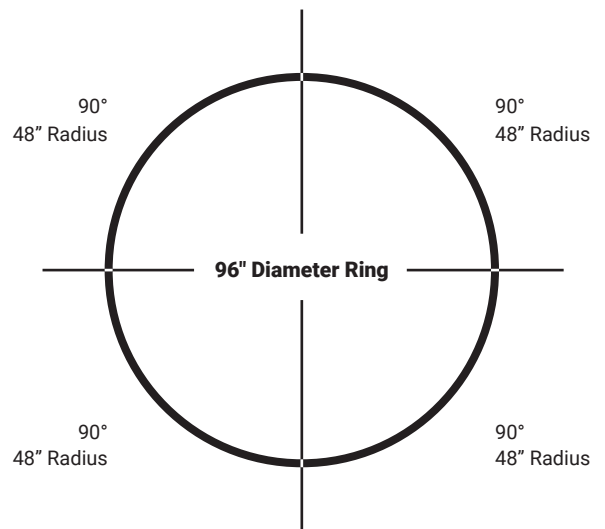
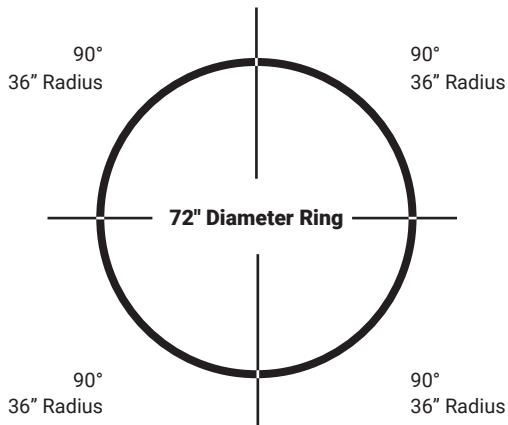

30 Degrees Custom radii and degrees available

Part# 30SOUL-R24

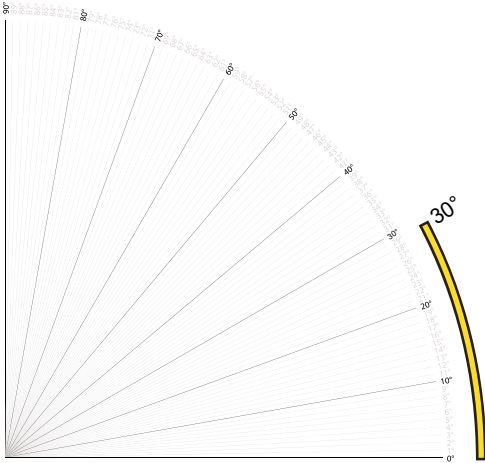
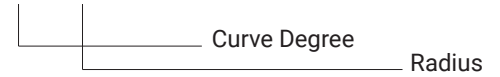

30 Degrees

A. Curve length / B. Chord Length / C. Radius

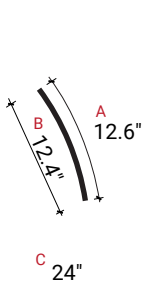

30SOUL-R24

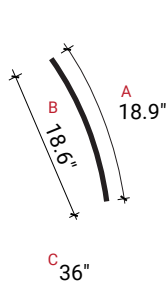

30SOUL-R36

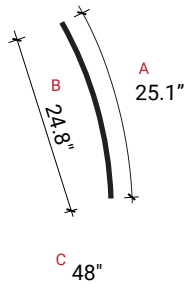

30SOUL-R48

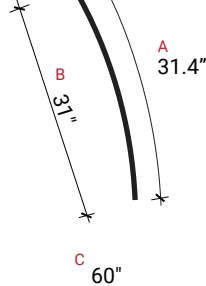

30SOUL-R60

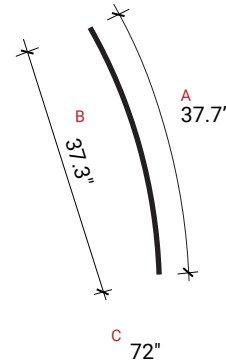

30SOUL-R72

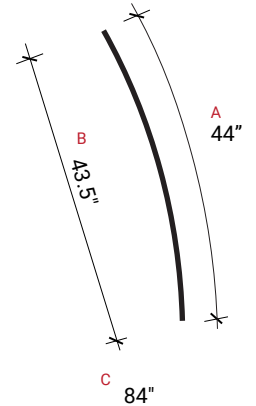

30SOUL-R84

45 Degrees Custom radii and degrees available

Part# 45SOUL-R24

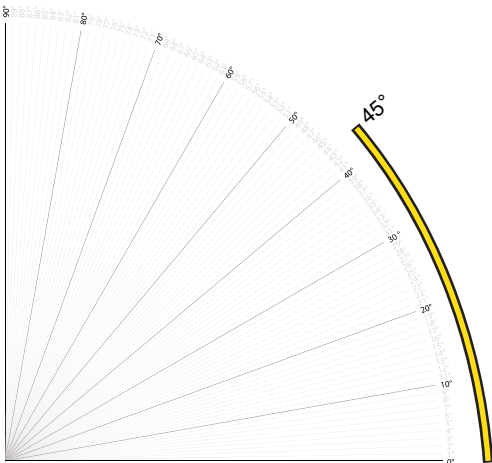
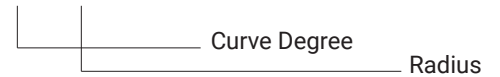

45 Degrees

A. Curve length / B. Chord Length / C. Radius

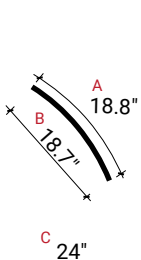

45SOUL-R24

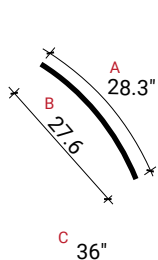

45SOUL-R36

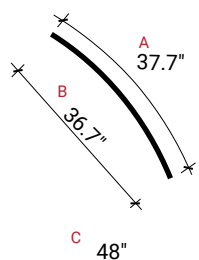

45SOUL-R48

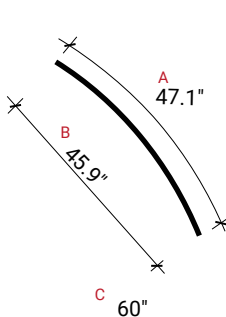

45SOUL-R60

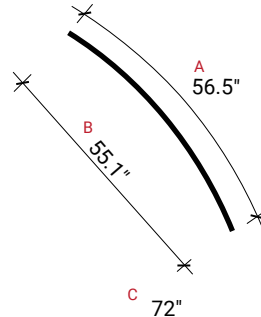

45SOUL-R72

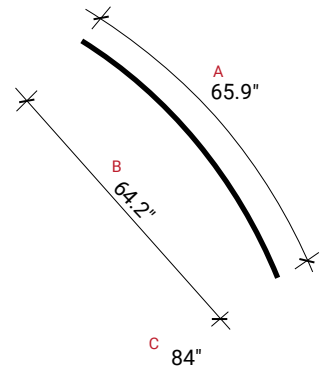

45SOUL-R84

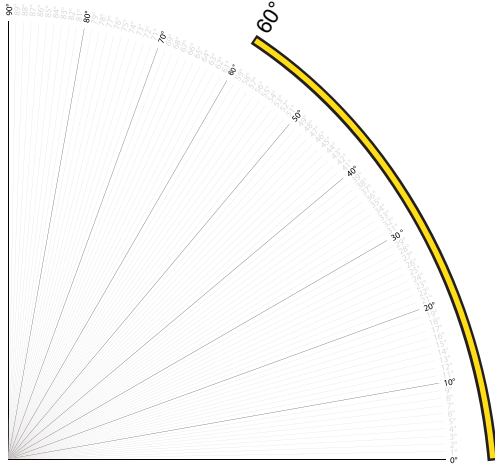

60 Degrees Custom radii and degrees available

Part# 60SOUL-R24

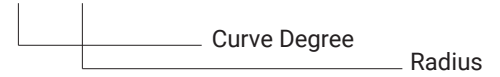

60 Degrees
A. Curve length / B. Chord Length / C. Radius

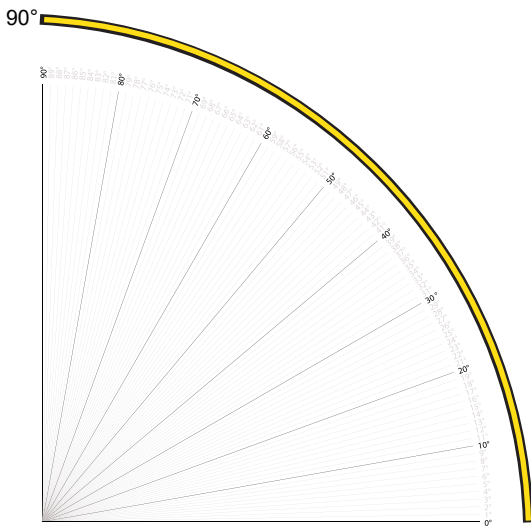
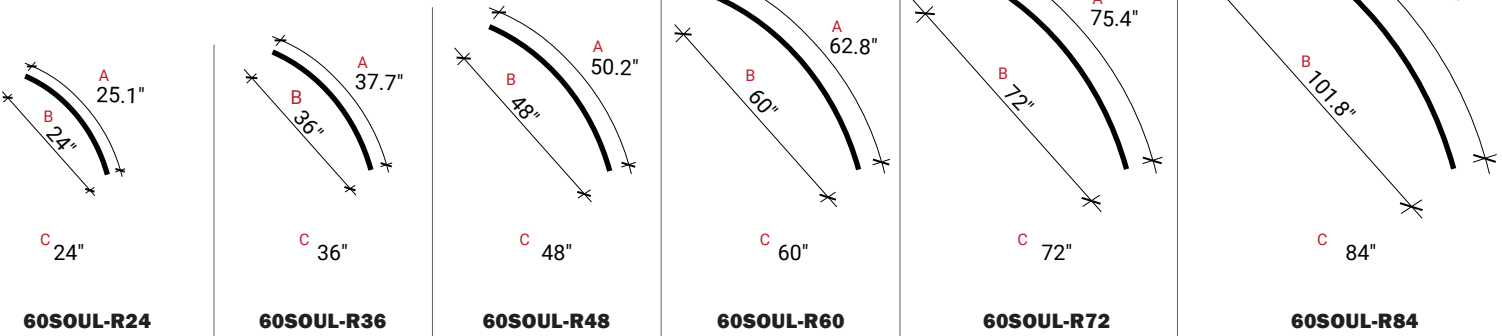

90 Degrees Custom radii and degrees available

Part# 90SOUL-R24

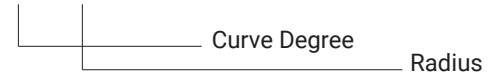

90 Degrees
A. Curve length / B. Chord Length / C. Radius

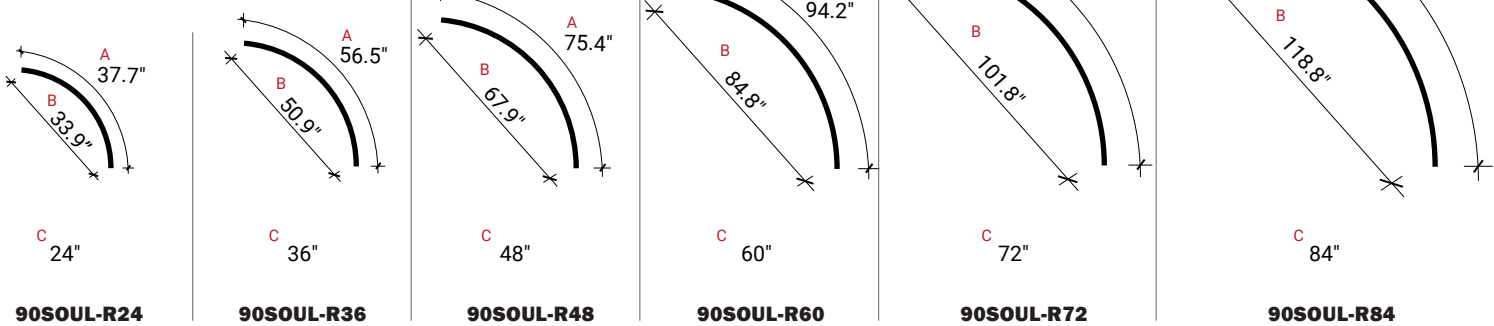

120 Degrees Custom radii and degrees available

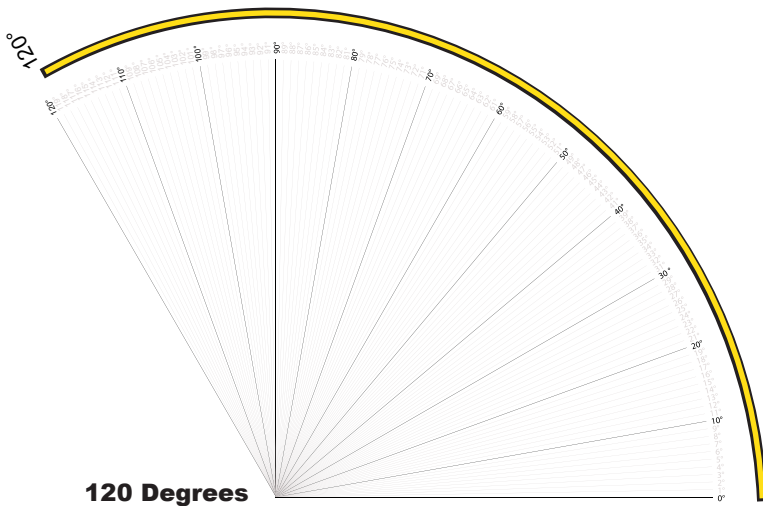

Part# 120SOUL-R24

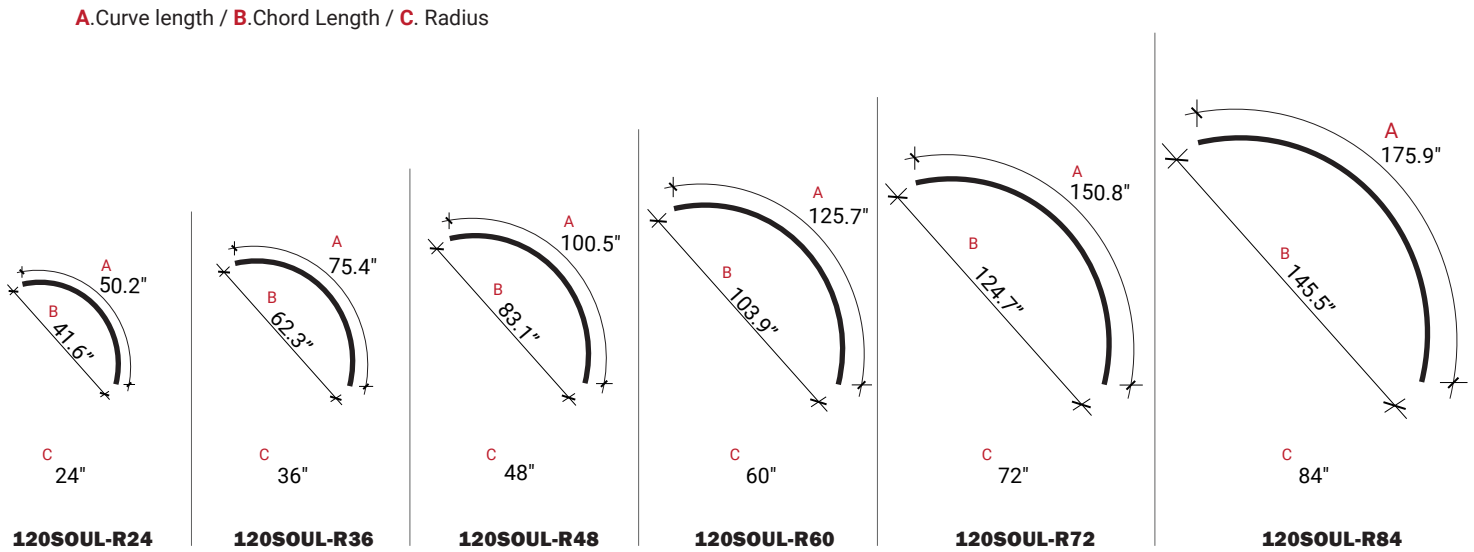
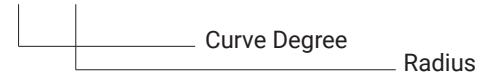

Straight Runs

Custom straight runs are available in increments of 1 inch

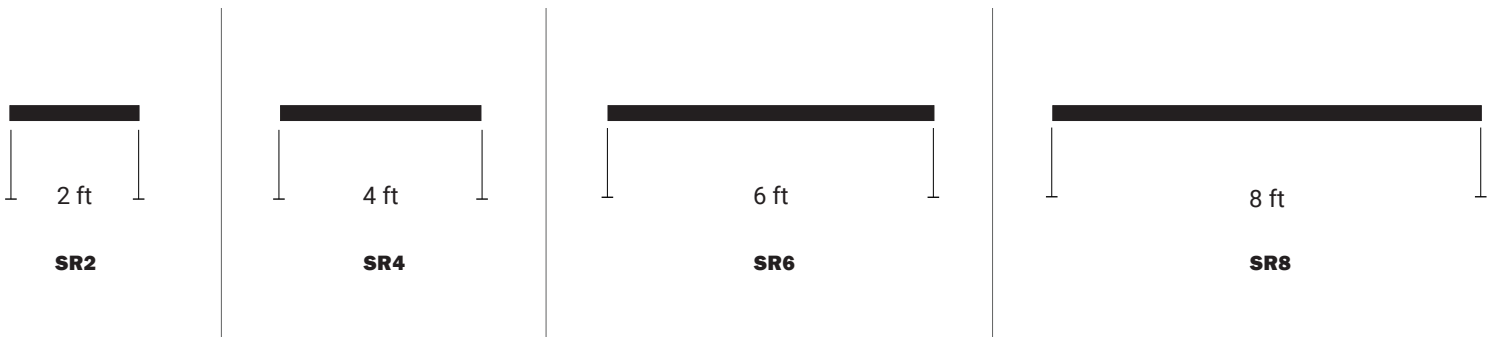

Curved Joiners

Curved joiners are essential for connecting arcs, curves, and continuous lengths. These joiners facilitate the creation of a variety of shapes with a rounded finish.

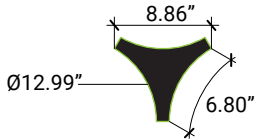

JY-SOUL1
Y-Shaped Joiner

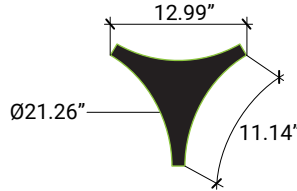

JY-SOUL2
Y-Shaped Joiner

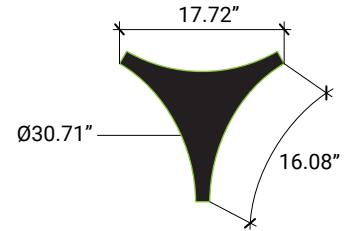

JY-SOUL3
Y-Shaped Joiner

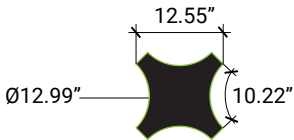

JX-SOUL1
X-Shaped Joiner

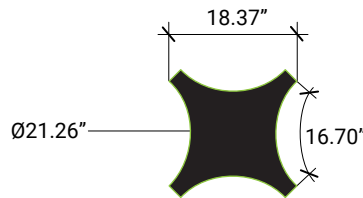

JX-SOUL2
X-Shaped Joiner

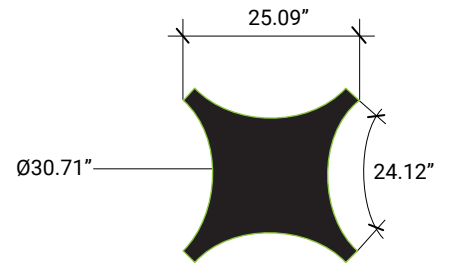

JX-SOUL3
X-Shaped Joiner

Samples

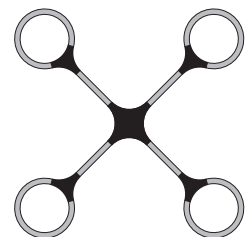
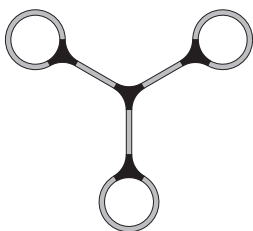

Sample Fixtures

From suspended mount to wall-mounted

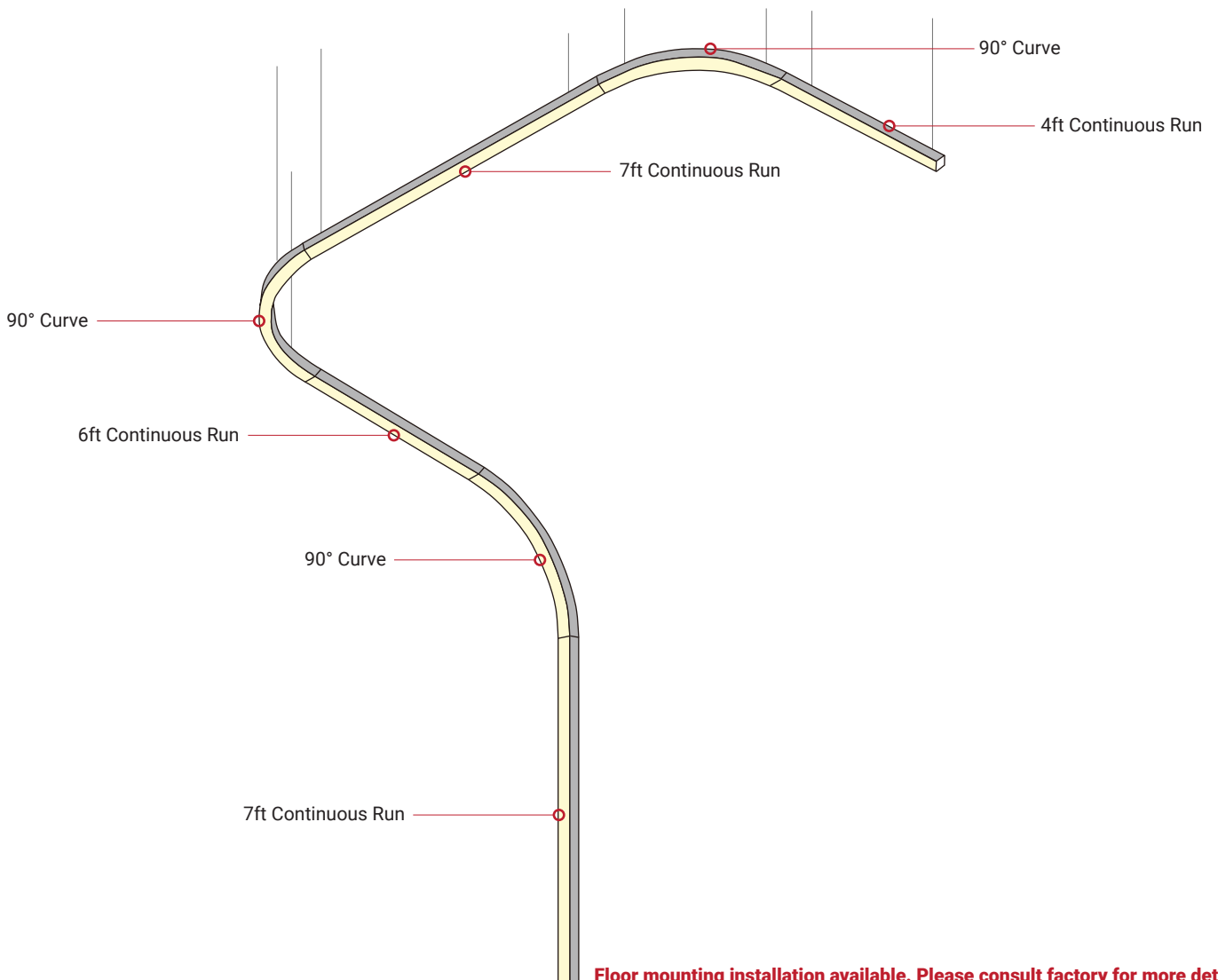
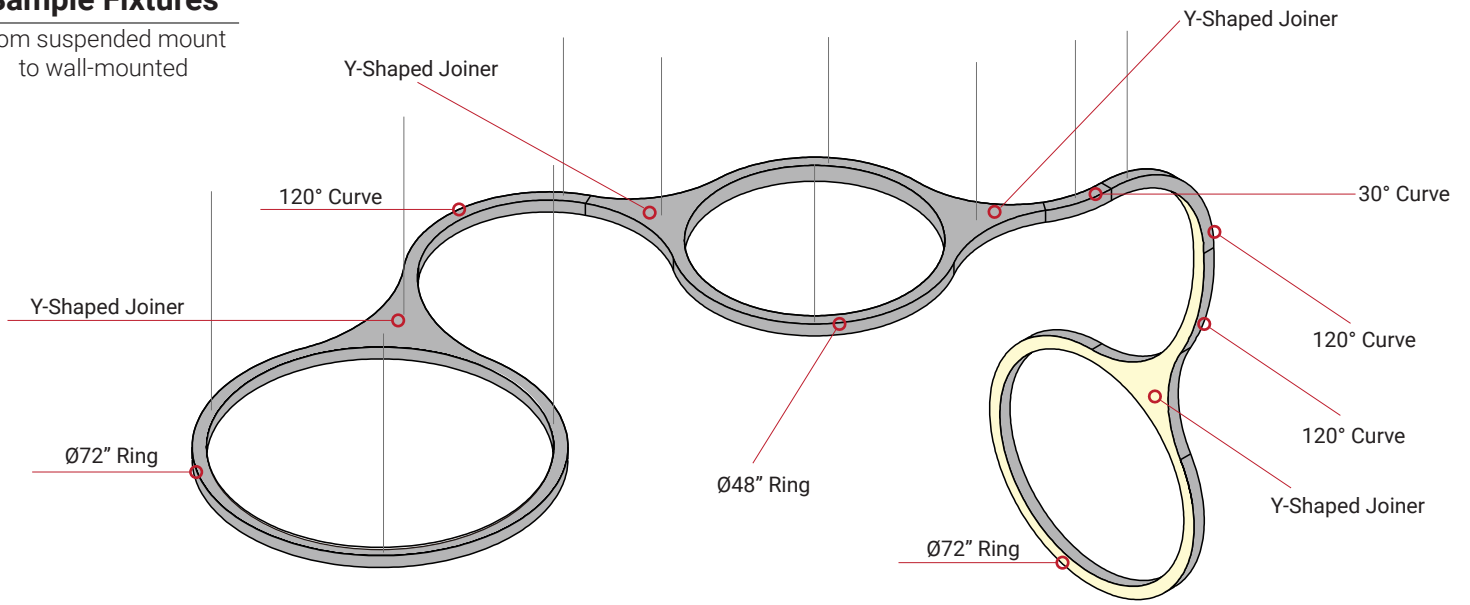

Floor mounting installation available. Please consult factory for more details.

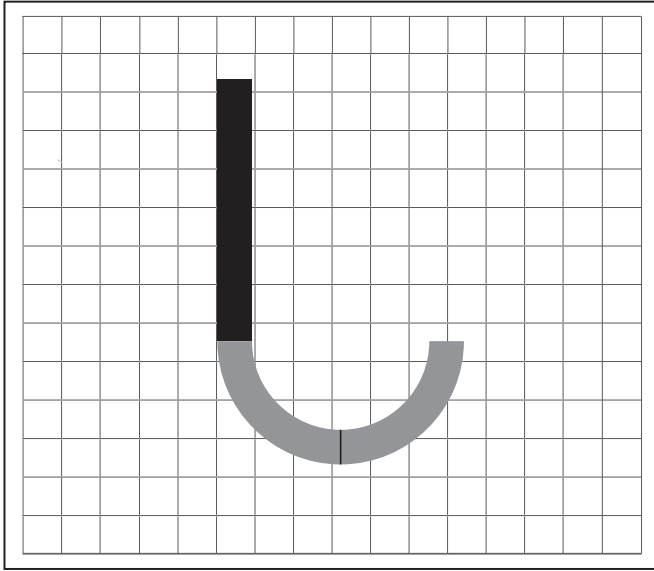

How to **design**
your OWN shapes!

1. Select the pieces you want to use to build the fixture and draw them on the grid. Refer to pages 4, 5, 6, and 7 to choose the desired pieces.
2. After drawing the fixture on the grid, send the design to yuchen@iuseelite.com
3. Once you approve the design, we will bring it to life.

PRACTICE!



Take a look at pages 4, 5, 6, and 7 and see if you can figure out which parts were used to assemble this luminaire.

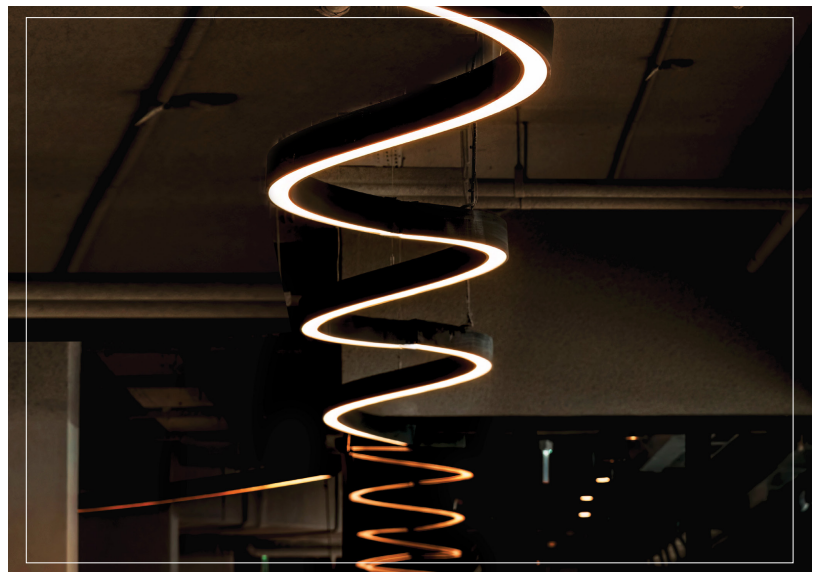
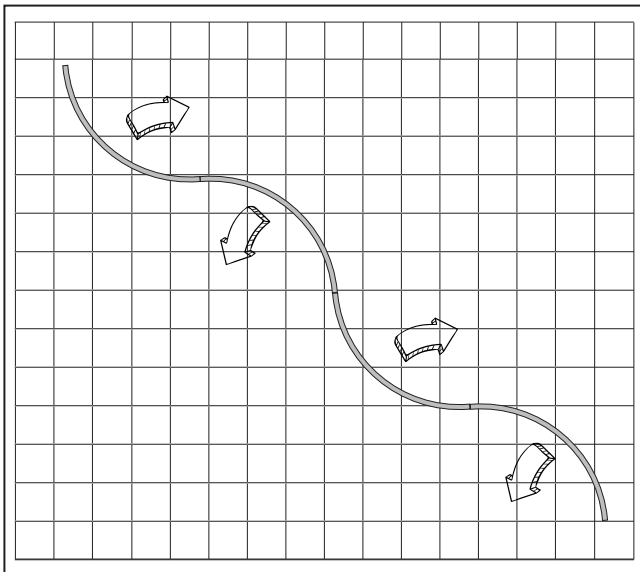

Curve Radius Part# _____

Straight Runs Part# _____

Luminaire Configuration Guide

SR-Straight Runs:

2 ft, 4 ft, 6 ft, 8 ft, Custom

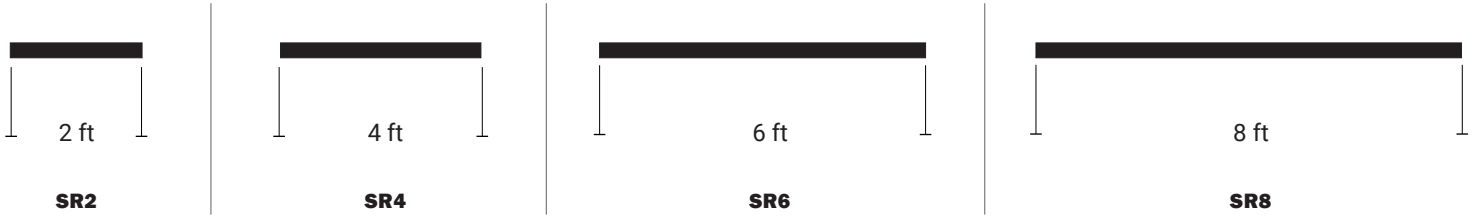

DC-DEGREE OF CURVE:

30°, 45°, 60°, 90°, 120°, Custom

R-CURVE RADIUS:

24", 36", 48", 60", 72", 84", Custom

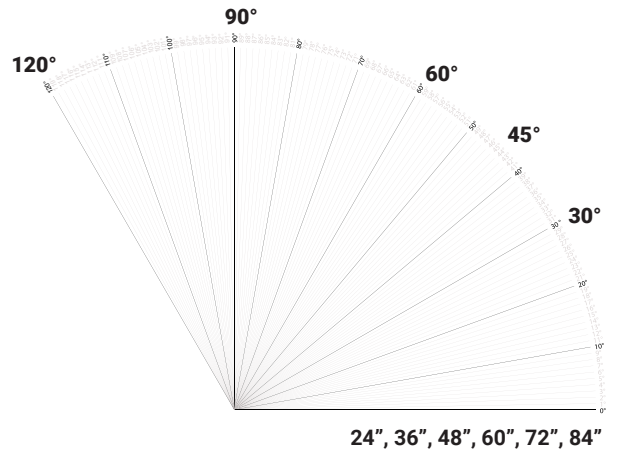

Be Inspired

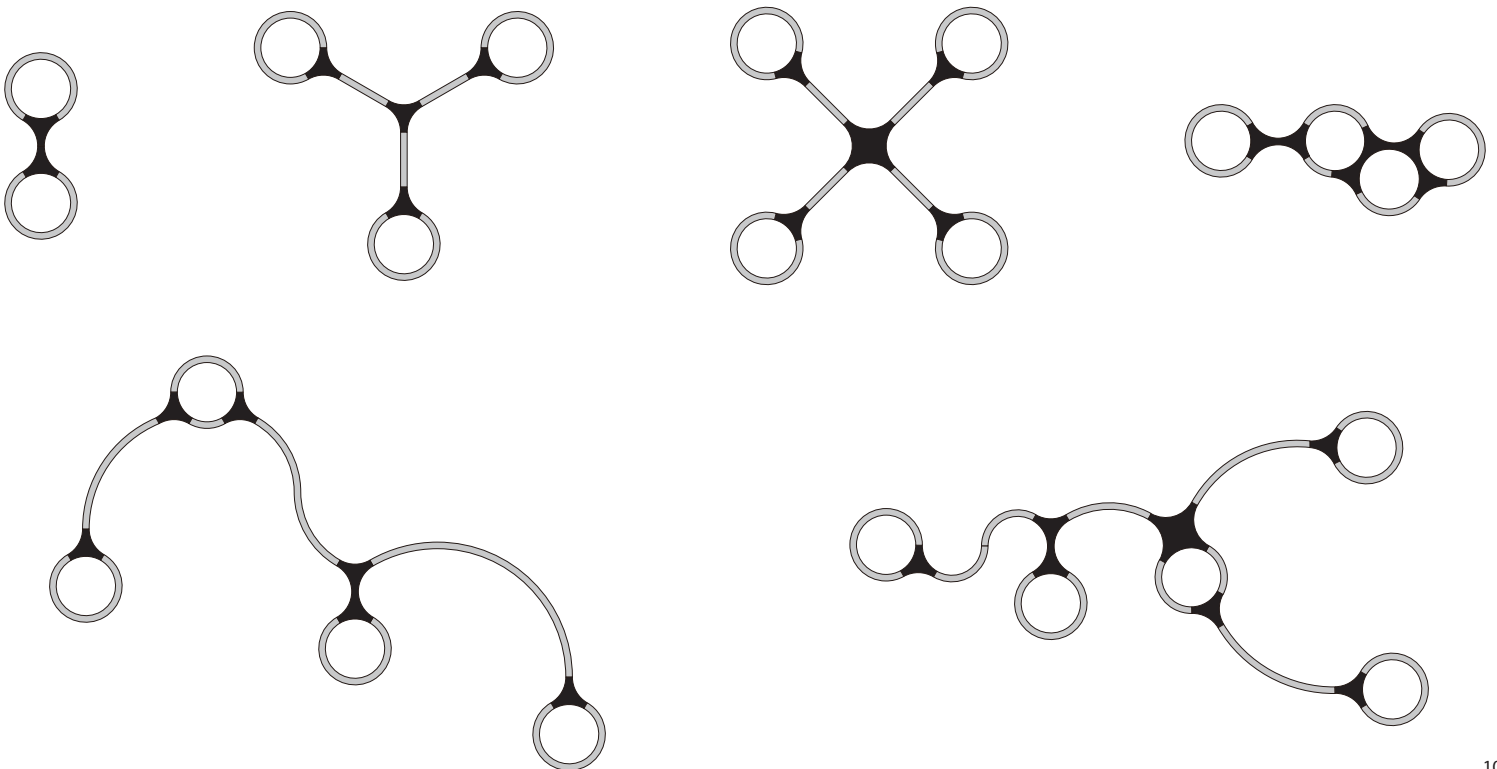

ORDERING TABLE

Example: SOULMATE-TWH-DI-SM-2-CUS-D650L-U300L-1C-REM-DIM10-MVOLT-6500K-2700K-95-WH

SERIES	WIDTH	¹ SHAPE	LUMENS / DIRECT	DISTRIBUTION	LUMENS / INDIRECT
SOULMATE-TWH-DI-SM	2 - 2.3"x2.3"	CUS - Custom <i>Sketch your design on the next page.</i>	D650L - 650 Lumens Per Ft D900L - 900 Lumens Per Ft	(blank) - Standard	U300L - 300 Lumens Per Ft U450L - 450 Lumens Per Ft

DISTRIBUTION	NUMBER OF CIRCUITS	DRIVER MOUNT	DIMMING	VOLTAGE
(blank) - Standard	1C (Up and down lights controlled together) 2C (Up and down lights controlled individually)	REM - Remote Driver	DIM10 - 0-10V Dimming ELDO10.1 - ELDO 0-10V ELDODMX.1 - EldoLED DMX ELDODALI.1 - ELDODALI.1 BLE - Wireless Bluetooth Control	MVOLT - 120-277V

CCT	CRI	FINISH	² EMERGENCY	TOTAL RUN / FT & IN
6500K - 2700K	90 - 90CRI 95 - 95CRI	WH - White BK - Black SI - Silver RAL - Consult Factory	REM-0-EMG-LED-10W REM-0-EMG-LED-20W	XX.YY.ZZ XX= Length in Feet YY= Fraction in Inches ZZ= Fractions of an Inch e.g. 22 ft. 6 in. 1/2 in

1. Please refer to the next page and sketch your design on the grid. Afterward, email it to yuchen@iuseelite.com with any required details.
2. Remote emergency option available, please consult factory.



Sketch your design using the grid space below and email it to yuchen@iuseelite.com



Square



Rectangle



Ring

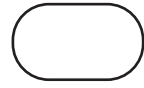

Oval



Free Pattern