

RGBW

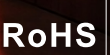

**INTRODUCING**

SOULMATE

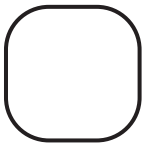

Square

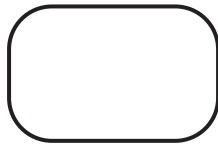

Rectangle

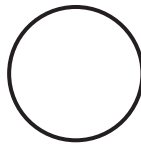

Circle

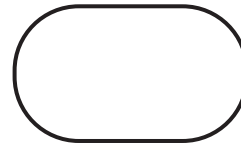

Oval

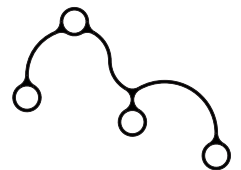

Free Pattern

**SOULMATE Infinity Shapes** – is a versatile Free-Form Shape LED luminaire that brings spirit, energy, and action to large space environments by harnessing the flexibility and creativity of a tapelight while maintaining the quality and durability of a solid luminaire. Designed to simultaneously enhance creativity and functionality in a space, SOULMATE helps create intricate, sprawling shapes by connecting rounded-edge SOUL shapes with curved joiners, elevating the versatility, flexibility, and creativity of SOUL luminaires to new heights.

Available with surface and wall mounting options, in a standard width of 2.3", in various lengths and angles that allow for playful design. Capable of max. continuous runs of 8 feet and ideal for adding an element of originality to corporate offices, educational, commercial, and retail spaces.

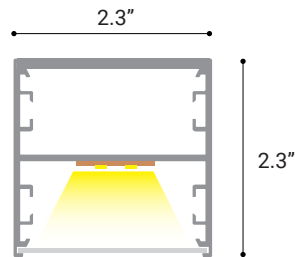

Size

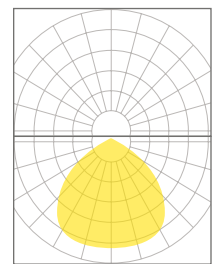

Ligth Distribution

**OPTICS & PERFORMANCE**

This item's high-efficiency LED optical system includes a precision-cut acrylic lens with a smooth frosted finish for glare-free, even illumination and reflective sidewalls that help distribute the LED light evenly across the acrylic-surface. The lens features a snap-in design that fits securely into the groove of the fixture's body, making it easy to remove for access to the LED driver and LED board. This SOUL-LED fixture can be customized into various shapes by assembling different angles and degrees to meet diverse architectural needs.

**CONSTRUCTION**

Body constructed from up to 90% recyclable, extruded architectural-grade 6063 aluminum with a minimum wall thickness of 0.075", to ensure durability and sustainability. Lenses are made from twin-layered, extruded high-impact acrylic, with a maximum single length of 8 ft.

**DISTRIBUTION PATTERNS & DIFFUSER**

Features an optically extruded, high-impact acrylic lens for a uniform, smooth illumination with reduced glare and precise light output control. Lens designed to snap securely into the housing and integrate seamlessly with the fixture, to ensure a refined and clean appearance.

**CRM INSTALLATION**

Lighting design will adhere to the factory shop drawing. For continuous mounting, the first section will always include the power supply feed. Housing connections will feature a joint bracket and a male/female connector for electrical connections. For special mounting requirements, please follow the provided mounting instructions.

**WALL MOUNT**

The wall mounted version of SOULMATE Infinity Shapes mounts directly over a horizontally wall mounted, standard 4-inch electrical box. Its wall bracket design allows for the fixture to be hung while making wiring connections. The power feed is on the left side of each unit, and all sections come pre-wired with push-in connectors for a quick installation. Fixtures can also be joined seamlessly for straight, continuous runs, thanks to a rigid alignment feature.

**LED DYNAMIC PLATFORM OPTIONS**

Luminaires using RGB+White Color Tuning Technology have a color tuning range of 6000-1650 (RGBW- 60K-16K) using ELITE platform components. Light can be dimmed from 100-0.1% while maintaining constant CCT. Gradients of saturated colors from 0.1-100% can be added to color points within the tuning range to change a spaces' atmosphere by manipulating the color temperature of the room to add exciting contrast, mimic natural light cues, and affect ambiance and human circadian rhythms.

**DIMMING & DRIVER INFORMATION**

**ELDODMX.1** - EldoLED PowerDrive dimming down to 0.1%.

**DMX512 & RDM** - 120-277V LED Driver

**BLE** - Luminaires may be controlled, grouped, scheduled or placed in scenes and or zones or both, via Cassambi Bluetooth 4.0 App.

**FINISH**

Standard color - White / Black / Anodized aluminum.  
RAL CLASSIC COLORS.

**WARRANTY**

Five-year warranty for parts and components.(Labor not included).

**LISTINGS**

**cETLus** - Listed

**RoHs** - Contains no mercury or lead and RoHS compliant

**TECHNICAL DETAILS**



<b>INPUT VOLTAGE</b>	120-277V
<b>POWER</b>	6W/ft, 9W/ft
<b>EFFICIENCY LM/W</b>	80Lm/W
<b>LUMENS PER FOOT</b>	500L, 750L
<b>CRI</b>	90+, 95+
<b>LIGHT DISTRIBUTION</b>	Direct
<b>CCT</b>	RGBW (35K standard option)
<b>SHAPES</b>	Square, Rectangle, Circle, Oval, and Free-form Pattern

<b>MOUNTING</b>	Wall Mount
<b>SIZE</b>	W2.3" x H2.3"
<b>CURVE DEGREES</b>	30°, 45°, 60°, 90°, 120° Custom Degrees Available
<b>CURVE RADIUS</b>	24", 36", 48", 60", 72", 84" Custom Radius Available
<b>CONTINUOUS LENGTHS</b>	2 ft, 4 ft, 6 ft, 8 ft Custom Lengths Available
<b>COLOR</b>	White, Black, Silver, Custom RAL
<b>DIMMING &amp; CONTROLS</b>	ELDODMX.1, DMX512 & RDM, BLE.
<b>EMERGENCY</b>	Remote Emergency Option. Consult Factory

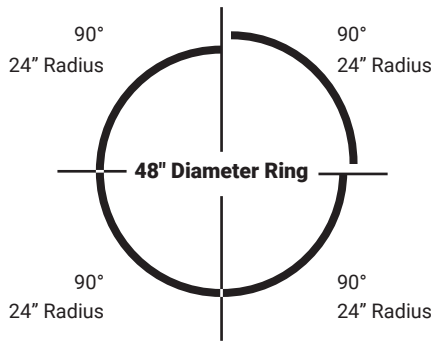

**Ring Diameters**

Made by individual segments

**Radius of Each Segment:** There are four, 90-degree segments, each with a radius of 24 inches.

**Complete Circle:** Four 90-degree segments come together to form a complete circle (360 degrees).

**Diameter Calculation:** The diameter of a circle is twice the radius. So, with a radius of 24 inches:

**Diameter**= 2×Radius=2×24=48inches

The diameter of the fixture ring is 48 inches.

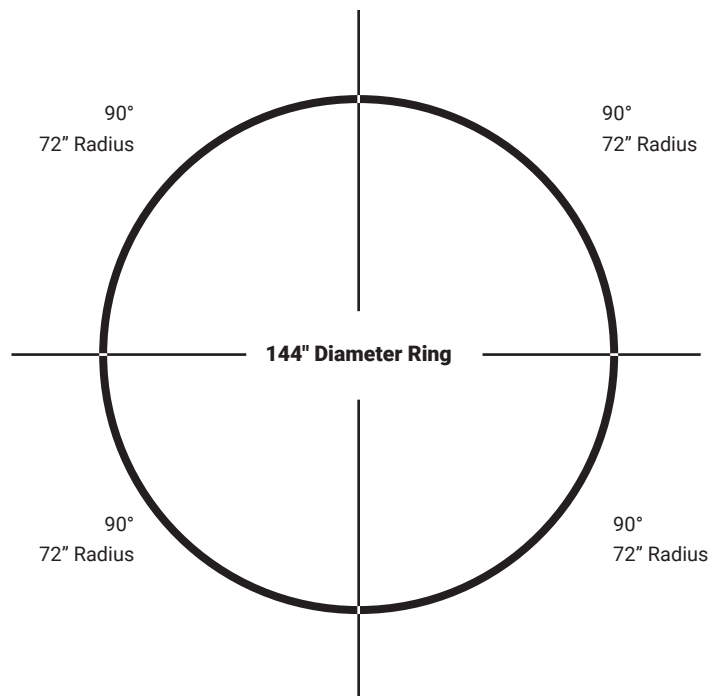
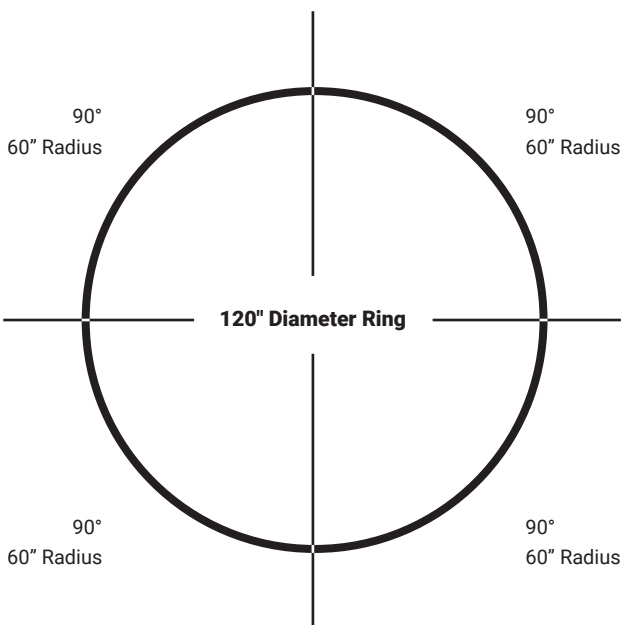
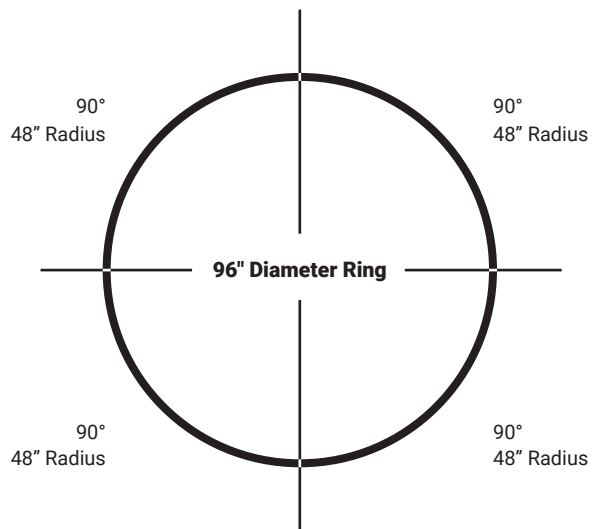
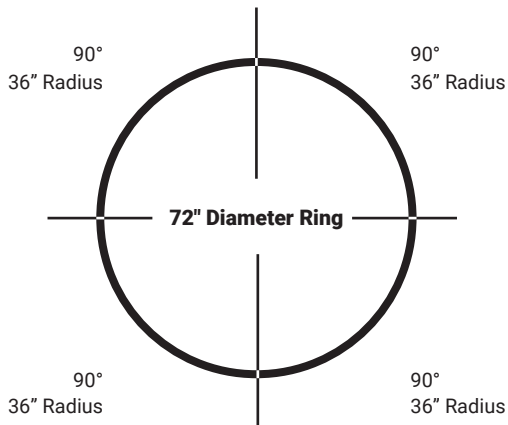

### 30 Degrees **Custom radii and degrees available**

**Part# 30SOUL-R24**

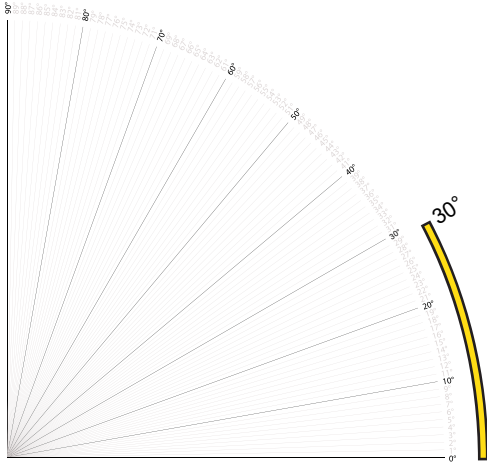
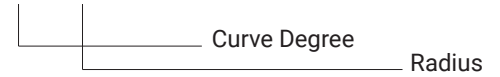

#### 30 Degrees

A. Curve length / B. Chord Length / C. Radius

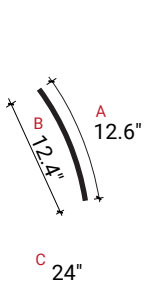

**30SOUL-R24**

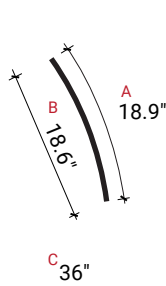

**30SOUL-R36**

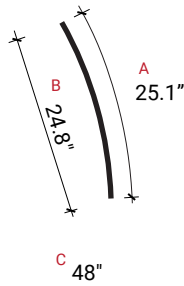

**30SOUL-R48**

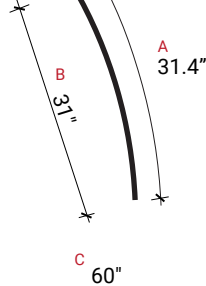

**30SOUL-R60**

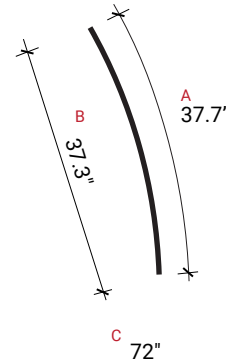

**30SOUL-R72**

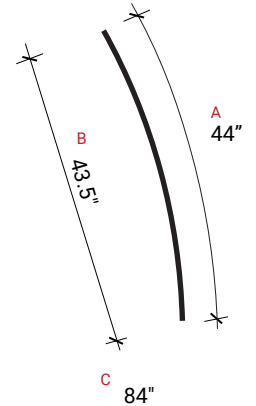

**30SOUL-R84**

### 45 Degrees **Custom radii and degrees available**

**Part# 45SOUL-R24**

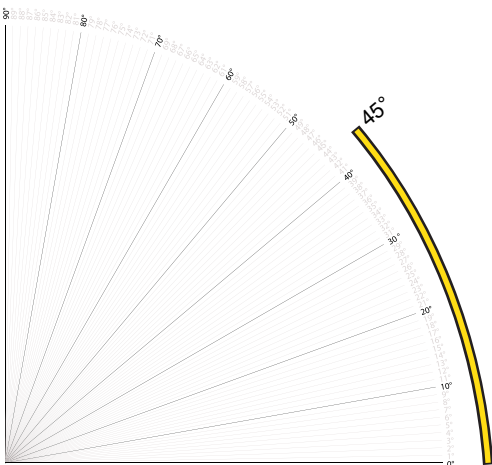
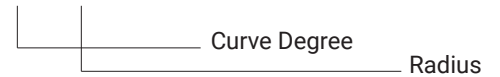

#### 45 Degrees

A. Curve length / B. Chord Length / C. Radius

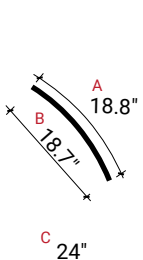

**45SOUL-R24**

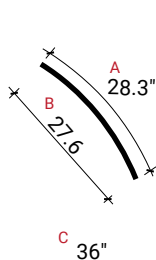

**45SOUL-R36**

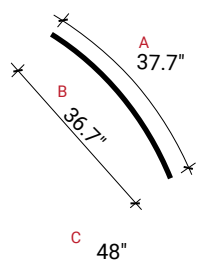

**45SOUL-R48**

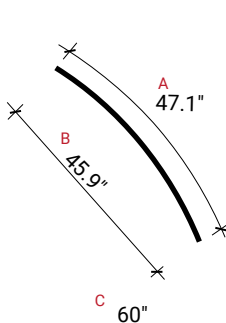

**45SOUL-R60**

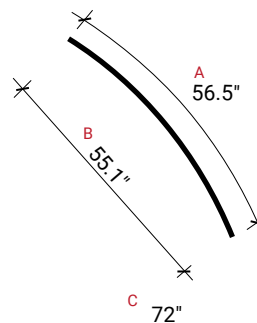

**45SOUL-R72**

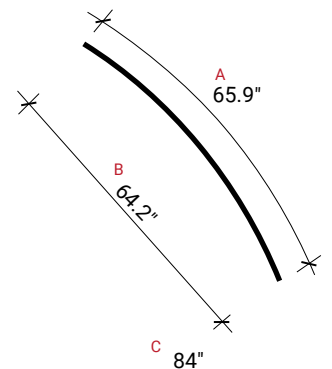

**45SOUL-R84**

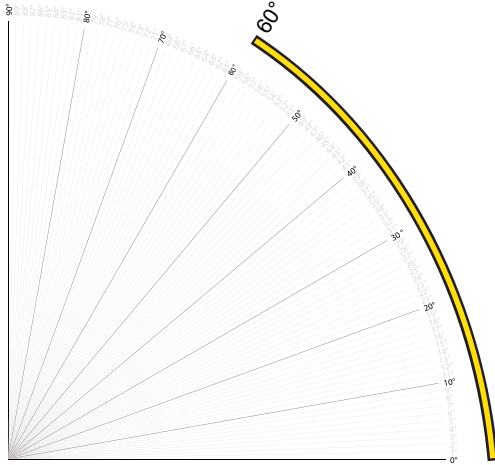

**60 Degrees**  
A. Curve length / B. Chord Length / C. Radius

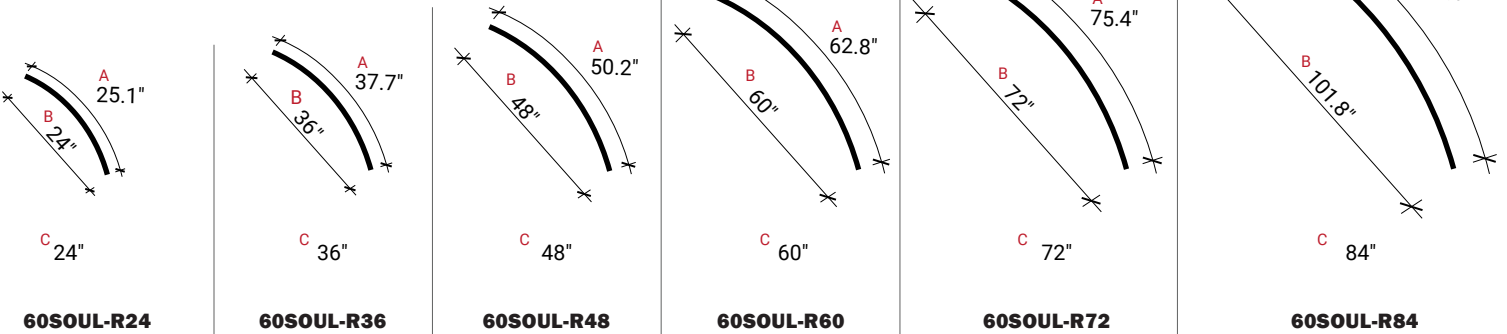

**60 Degrees** Custom radii and degrees available

Part# 60SOUL-R24

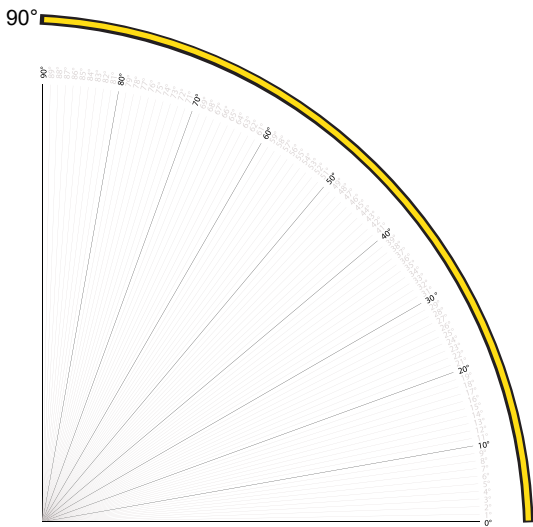
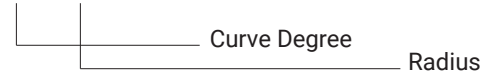

**90 Degrees**  
A. Curve length / B. Chord Length / C. Radius

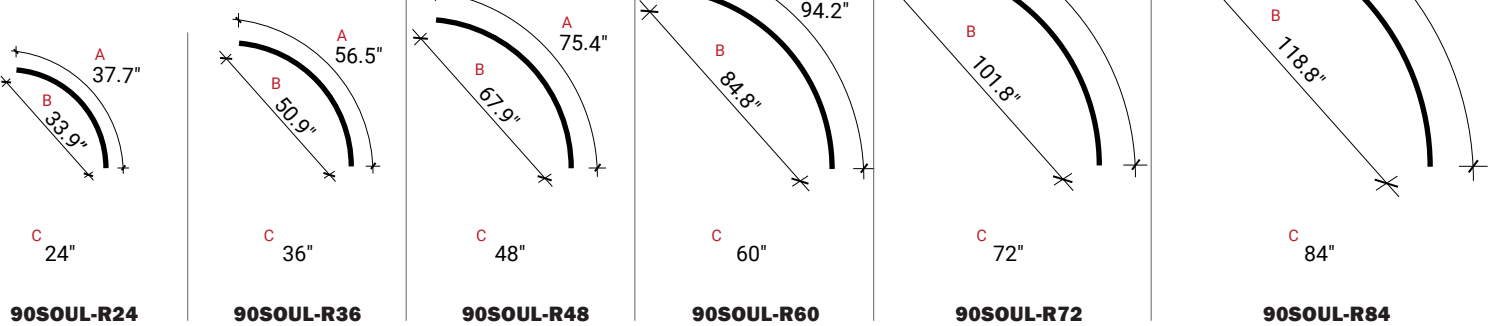

**90 Degrees** Custom radii and degrees available

Part# 90SOUL-R24

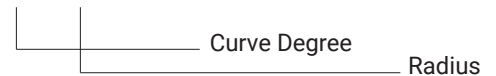

**120 Degrees** Custom radii and degrees available

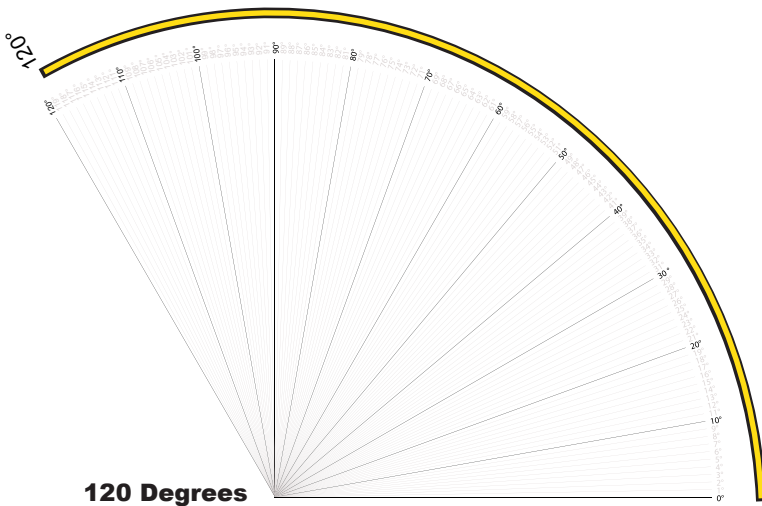

**120 Degrees**  
A. Curve length / B. Chord Length / C. Radius

**Part# 120SOUL-R24**

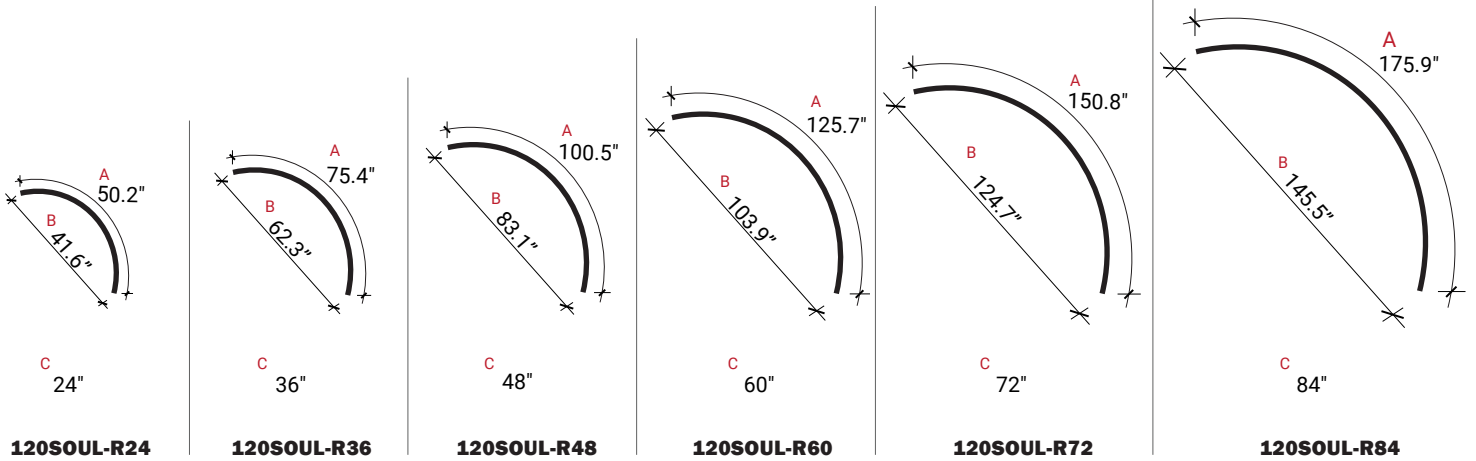

**Straight Runs**

Custom straight runs are available in increments of 1 inch

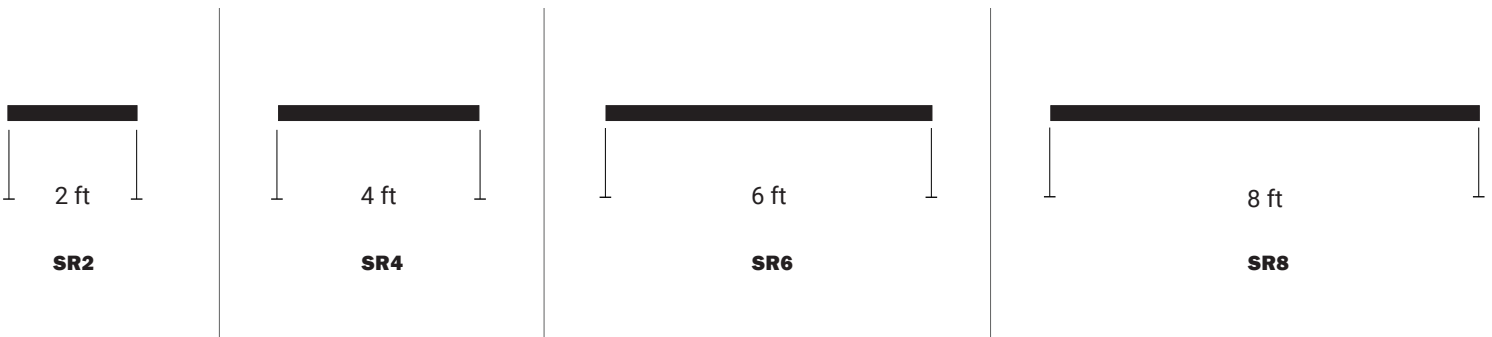

**Curved Joiners**

Curved joiners are essential for connecting arcs, curves, and continuous lengths. These joiners facilitate the creation of a variety of shapes with a rounded finish.

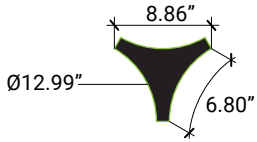

**JY-SOUL1**  
Y-Shaped Joiner

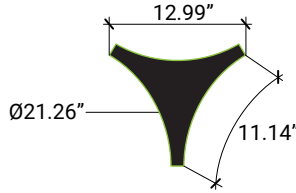

**JY-SOUL2**  
Y-Shaped Joiner

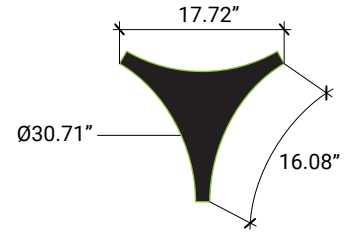

**JY-SOUL3**  
Y-Shaped Joiner

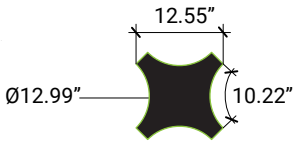

**JX-SOUL1**  
X-Shaped Joiner

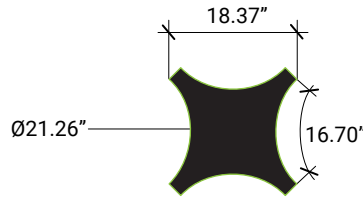

**JX-SOUL2**  
X-Shaped Joiner

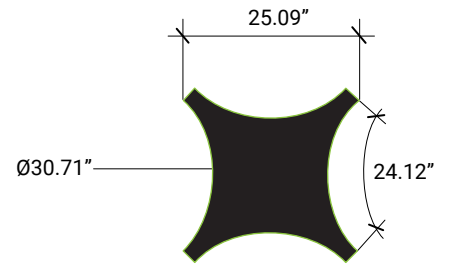

**JX-SOUL3**  
X-Shaped Joiner

**Samples**

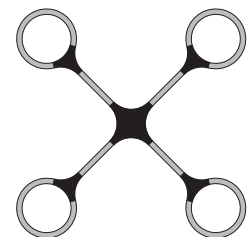
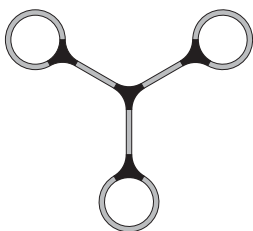

**Sample Fixtures**

From suspended mount  
to wall-mounted

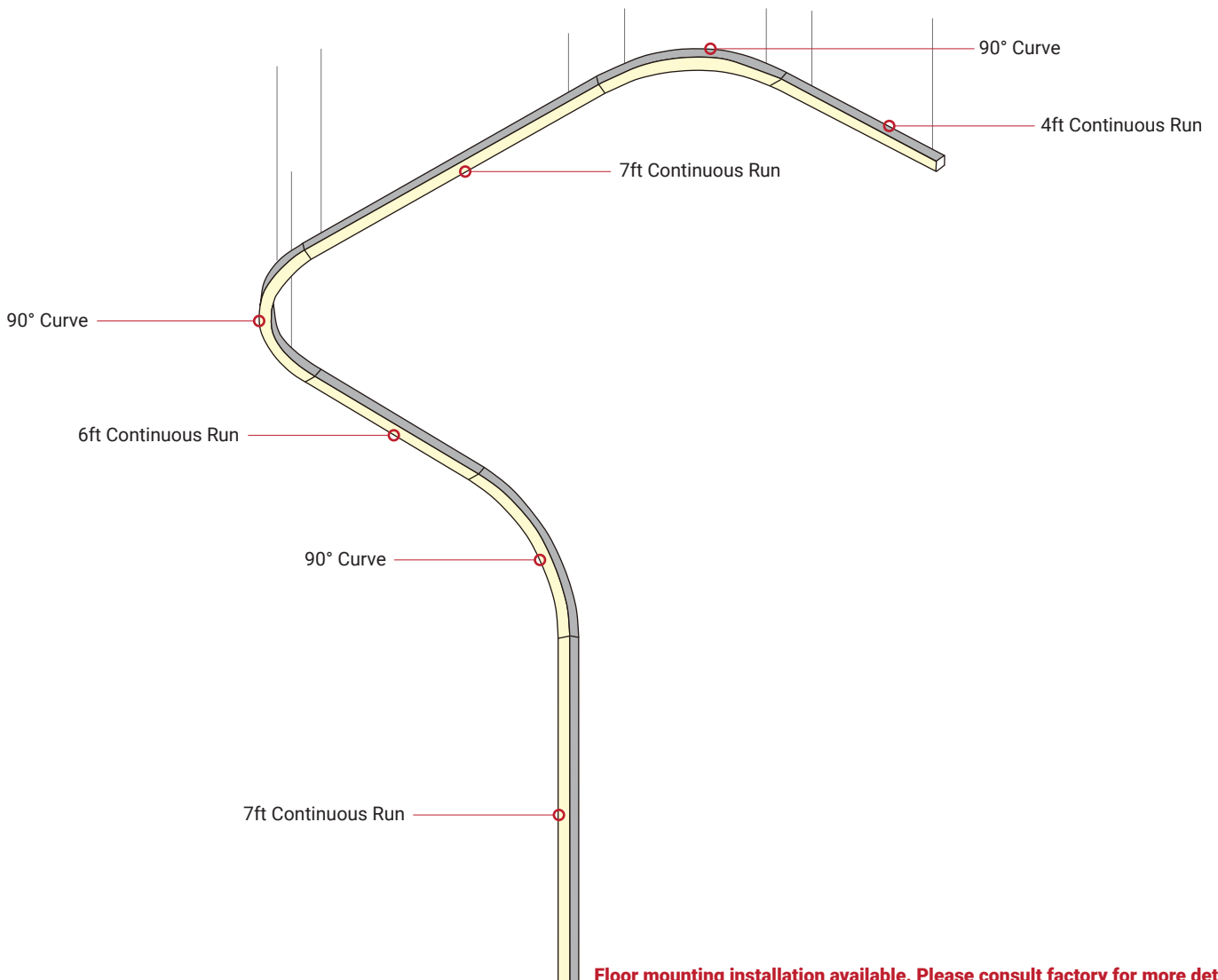
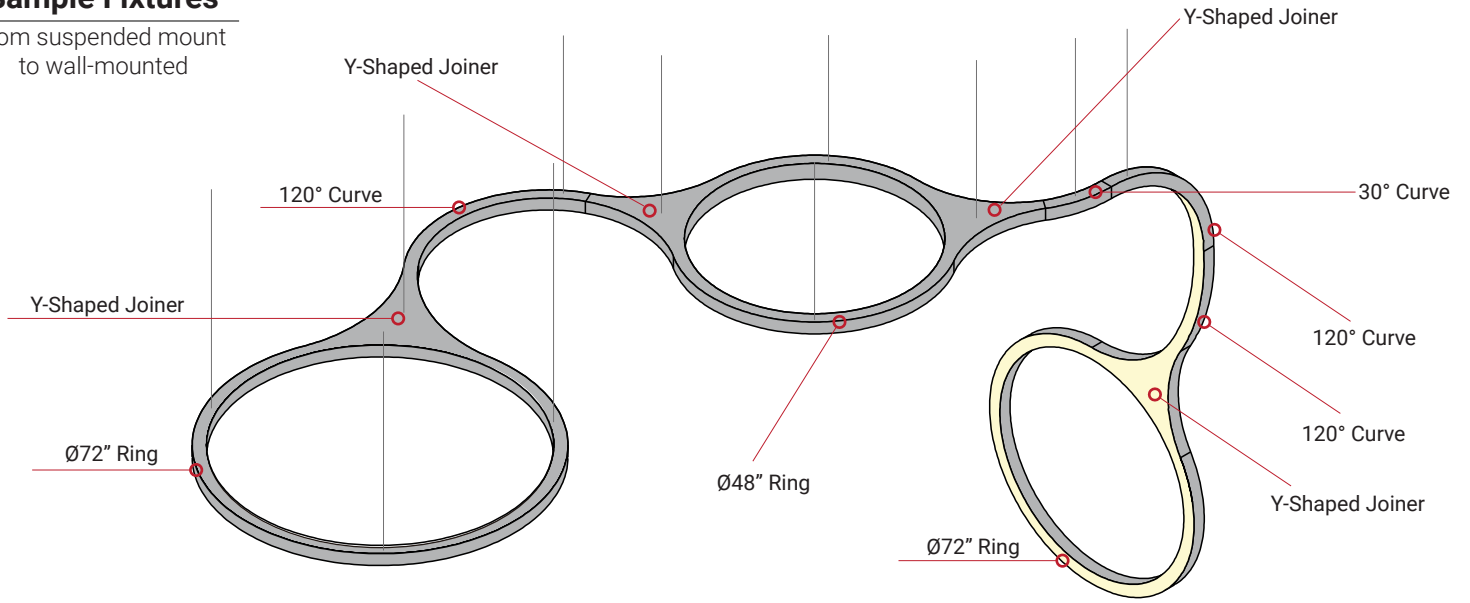

**Floor mounting installation available. Please consult factory for more details.**

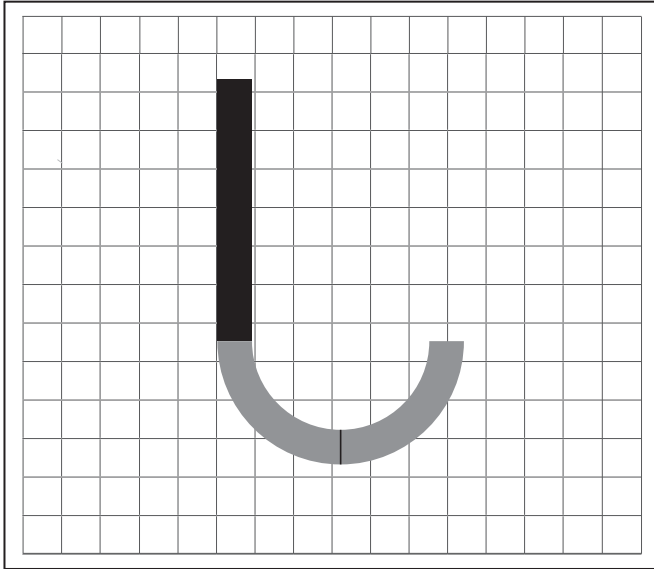

## How to **design** **your** OWN shapes!

1. Select the pieces you want to use to build the fixture and draw them on the grid. Refer to pages 4, 5, 6, and 7 to choose the desired pieces.
2. After drawing the fixture on the grid, send the design to [yuchen@iuseelite.com](mailto:yuchen@iuseelite.com)
3. Once you approve the design, we will bring it to life.

## PRACTICE!

Take a look at pages 4, 5, 6, and 7 and see if you can figure out which parts were used to assemble this luminaire. 

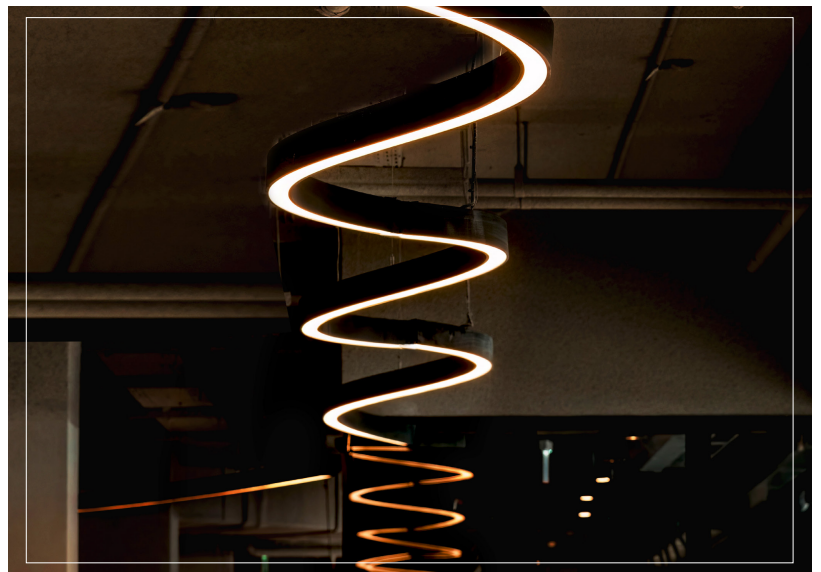
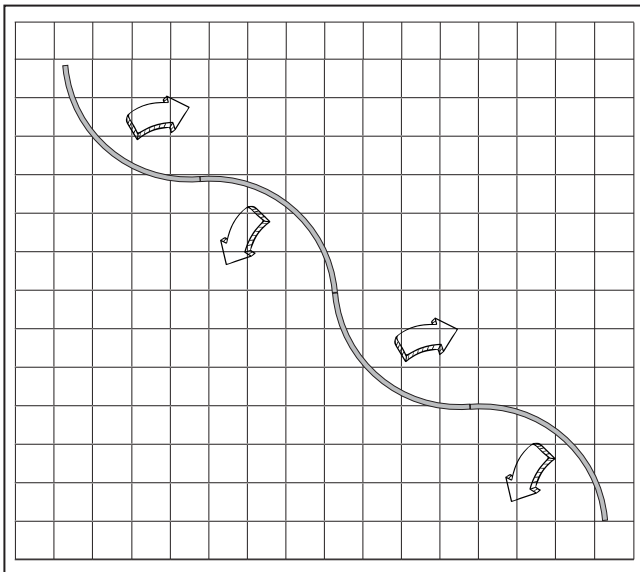

Image shown: Suspended wave luminaire. Wave shapes can also be installed as wall mounts.

Curve Radius Part# \_\_\_\_\_

Straight Runs Part# \_\_\_\_\_

**Luminaire Configuration Guide**

**SR-Straight Runs:**

2 ft, 4 ft, 6 ft, 8 ft, Custom

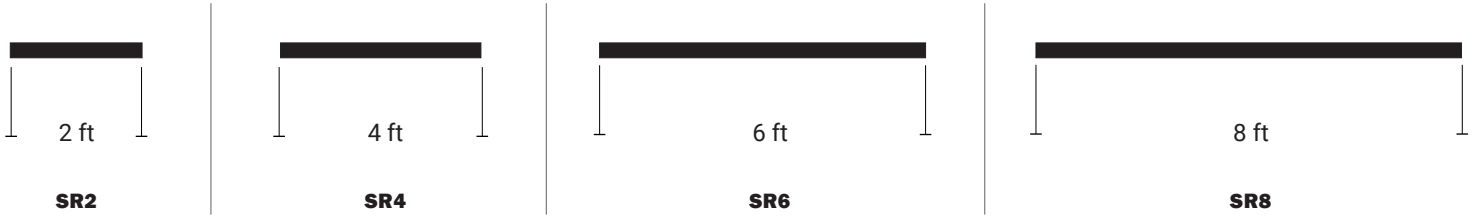

**DC-DEGREE OF CURVE:**

30°, 45°, 60°, 90°, 120°, Custom

**R-CURVE RADIUS:**

24", 36", 48", 60", 72", 84", Custom

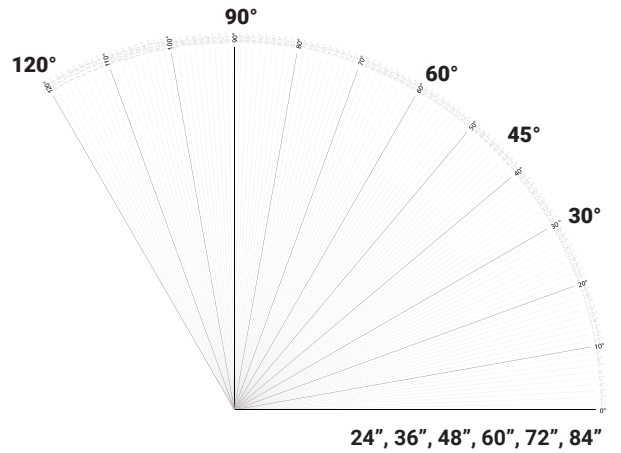

**Be Inspired**

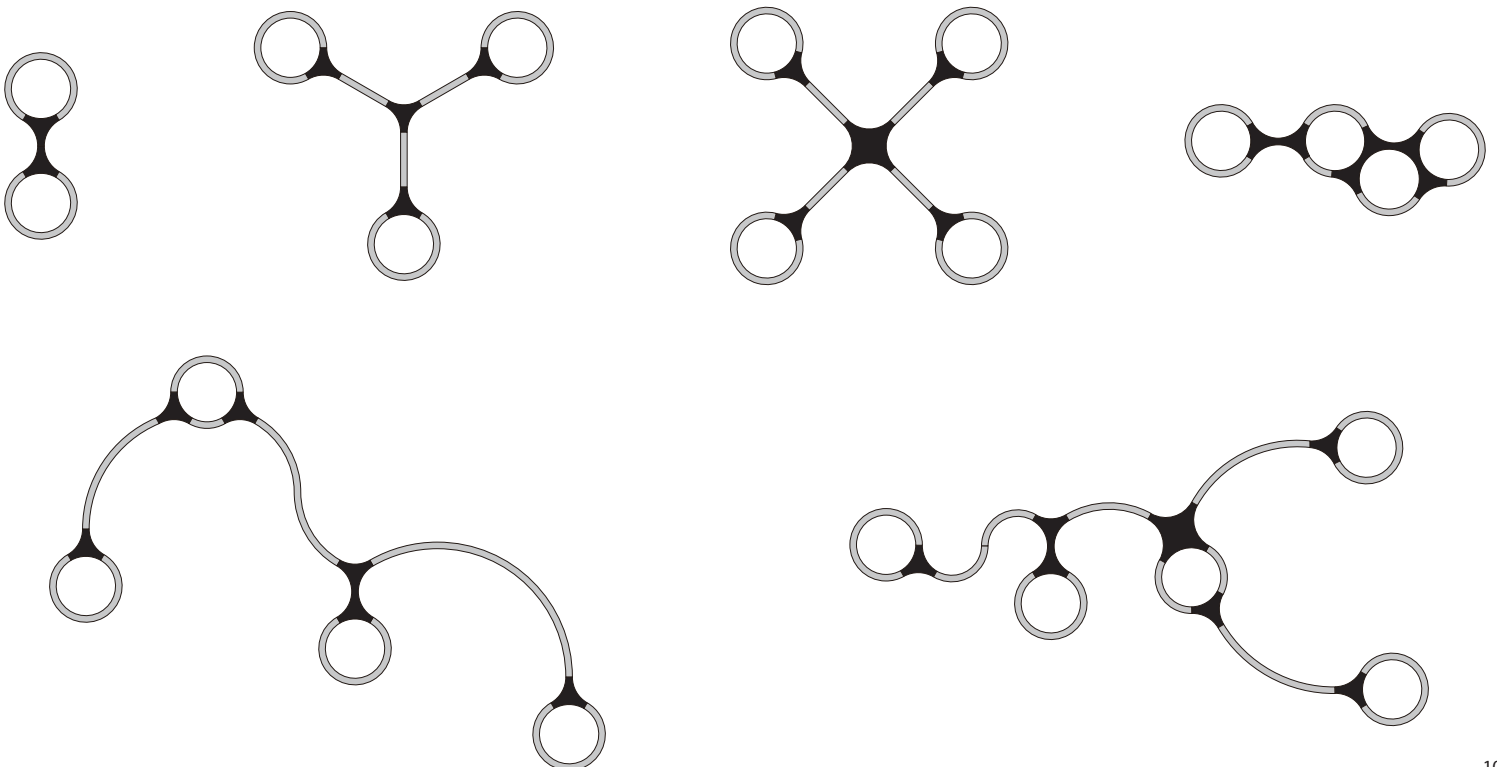

**ORDERING TABLE**

Example: SOULMATE-RGB-WM-2-CUS-D500L-1C-REM-DMX512-RDM-MVOLT-90-WH

SERIES	WIDTH	<sup>1</sup> SHAPE	LUMENS / DIRECT	DISTRIBUTION	NUMBER OF CIRCUITS
SOULMATE- <span style="color: red;">RGB</span> -WM	2 - 2.3"x2.3"	<b>CUS</b> - Custom <i>Sketch your design on the next page.</i>	<b>D500L</b> - 500 Lumens Per Ft <b>D750L</b> - 750 Lumens Per Ft	<b>(blank)</b> - Standard	<b>1C</b> <b>2C</b>

DRIVER MOUNT	DIMMING	VOLTAGE	CRI	FINISH	<sup>2</sup> EMERGENCY
<b>REM</b> - Remote Driver	<b>DMX512-RDM</b> - DMX512 & RDM <b>ELDODMX.1</b> - EldoLED DMX <b>BLE</b> - Wireless Bluetooth Control	<b>MVOLT</b> - 120-277V	<b>90</b> - 90CRI <b>95</b> - 95CRI	<b>WH</b> - White <b>BK</b> - Black <b>SI</b> - Silver <b>RAL</b> - Consult Factory	<b>REM-0-EMG-LED-10W</b> <b>REM-0-EMG-LED-20W</b>

TOTAL RUN / FT & IN

XX.YY.ZZ

XX= Length in Feet  
YY= Fraction in Inches  
ZZ= Fractions of an Inch  
e.g. 22 ft. 6 in. 1/2 in

1. Please refer to the next page and sketch your design on the grid. Afterward, email it to [yuchen@iuseelite.com](mailto:yuchen@iuseelite.com) with any required details.
2. Remote emergency option available, please consult factory.



Sketch your design using the grid space below and email it to [yuchen@iuseelite.com](mailto:yuchen@iuseelite.com)



Square



Rectangle



Ring

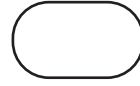

Oval



Free Pattern