

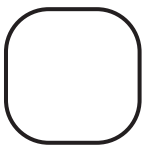

INTRODUCING
SOULMATE

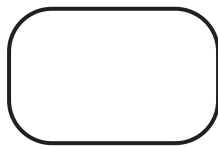

Square



Rectangle

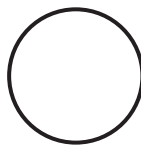

Circle

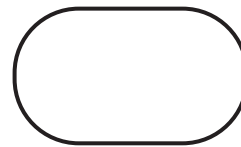

Oval

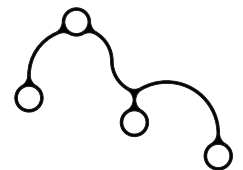

Free Pattern

SOULMATE Infinity Shapes — is a versatile Free-Form Shape LED luminaire that brings spirit, energy, and action to large space environments by harnessing the flexibility and creativity of a tapelight while maintaining the quality and durability of a solid luminaire. Designed to simultaneously enhance creativity and functionality in a space, SOULMATE helps create intricate, sprawling shapes by connecting rounded-edge SOUL shapes with curved joiners, elevating the versatility, flexibility, and creativity of SOUL luminaires to new heights.

Available with surface mount, ceiling mount, recessed trimless mount, and wall mounting options, in a standard width of 2.3", in various lengths and angles that allow for playful design. Capable of max. continuous runs of 8 feet and ideal for adding an element of originality to corporate offices, educational, commercial, and retail spaces.

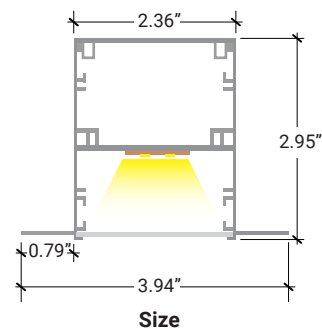

OPTICS & PERFORMANCE

This item's high-efficiency LED optical system includes a precision-cut acrylic lens with a smooth frosted finish for glare-free, even illumination and reflective sidewalls that help distribute the LED light evenly across the acrylic-surface. The lens features a snap-in design that fits securely into the groove of the fixture's body, making it easy to remove for access to the LED driver and LED board. This SOUL-LED fixture can be customized into various shapes by assembling different angles and degrees to meet diverse architectural needs.

CONSTRUCTION

Body constructed from up to 90% recyclable, extruded architectural-grade 6063 aluminum with a minimum wall thickness of 0.075", to ensure durability and sustainability. Lenses are made from twin-layered, extruded high-impact acrylic, with a maximum single length of 8 ft.

DISTRIBUTION PATTERNS & DIFFUSER

Features an optically extruded, high-impact acrylic lens for a uniform, smooth illumination with reduced glare and precise light output control. Lens designed to snap securely into the housing and integrate seamlessly with the fixture, to ensure a refined and clean appearance.

CRM INSTALLATION

Lighting design will adhere to the factory shop drawing. For continuous mounting, the first section will always include the power supply feed. Housing connections will feature a joint bracket and a male/female connector for electrical connections. For special mounting requirements, please follow the provided mounting instructions.

RECESSED TRIMLESS MOUNT

Designed for installation on drywall. Not compatible with T-bar or suspended (drop) ceilings.

For trimless recessed mounting, make a precise cutout that matches the shape and size of the fixture. Secure the integrated flanges of the luminaire directly to the ceiling structure with screws, ensuring proper alignment and support. Wire each segment before installing the next for easier handling, and follow the installation and wiring diagrams provided with the custom factory drawings.

After the fixture is secured, apply plaster or joint compound over the flanges and finish the ceiling surface to achieve a seamless, trimless appearance.

Floor mounting is available for decorative purposes only. Please consult factory for additional information.

LED DYNAMIC PLATFORM OPTIONS

Luminaires using RGB+White Color Tuning Technology have a color tuning range of 6000-1650 (RGBW- 60K-16K) using ELITE platform components. Light can be dimmed from 100-0.1% while maintaining constant CCT. Gradients of saturated colors from 0.1-100% can be added to color points within the tuning range to change a spaces' atmosphere by manipulating the color temperature of the room to add exciting contrast, mimic natural light cues, and affect ambiance and human circadian rhythms.

DIMMING & DRIVER INFORMATION

ELDODMX.1 - EldoLED PowerDrive dimming down to 0.1%.

DMX512 & RDM - 120-277V LED Driver

BLE - Luminaires may be controlled, grouped, scheduled or placed in scenes and or zones or both, via Cassambi Bluetooth 4.0 App.

FINISH

Standard color - White / Black / Anodized aluminum.
RAL CLASSIC COLORS.

WARRANTY

Five-year warranty for parts and components.(Labor not included).

LISTINGS

cETLus - Listed

RoHs - Contains no mercury or lead and RoHS compliant

TECHNICAL DETAILS



INPUT VOLTAGE	120-277V
POWER	6W/ft, 9W/ft
EFFICIENCY LM/W	80Lm/W
LUMENS PER FOOT	500L, 750L
CRI	90+, 95+
LIGHT DISTRIBUTION	Direct
CCT	RGBW (35K standard option)
SHAPES	Square, Rectangle, Circle, Oval, and Free-form Pattern

MOUNTING	Recessed Trimless Mount
SIZE	W 2.36" x H 2.95" (3.94" flange-to-flange)
CURVE DEGREES	30°, 45°, 60°, 90°, 120° Custom Degrees Available
CURVE RADIUS	24", 36", 48", 60", 72", 84" Custom Radius Available
CONTINUOUS LENGTHS	2 ft, 4 ft, 6 ft, 8 ft Custom Lengths Available
COLOR	White, Black, Silver, Custom RAL
DIMMING & CONTROLS	ELDODMX.1, DMX512 & RDM, BLE.
EMERGENCY	Remote Emergency Option. Consult Factory

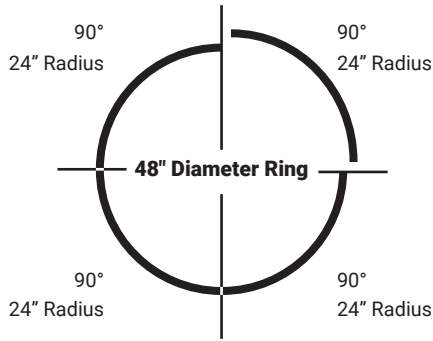

Ring Diameters

Made by individual segments

Radius of Each Segment: There are four, 90-degree segments, each with a radius of 24 inches.

Complete Circle: Four 90-degree segments come together to form a complete circle (360 degrees).

Diameter Calculation: The diameter of a circle is twice the radius. So, with a radius of 24 inches:

Diameter= 2×Radius=2×24=48inches

The diameter of the fixture ring is 48 inches.

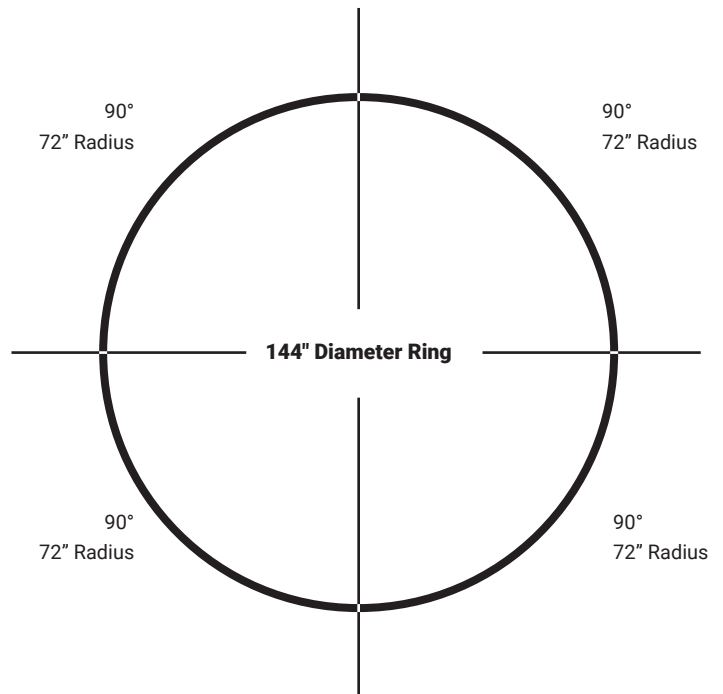
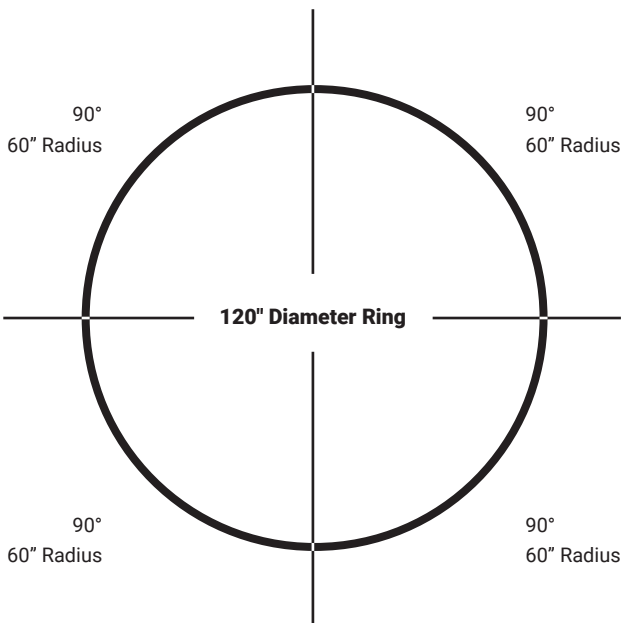
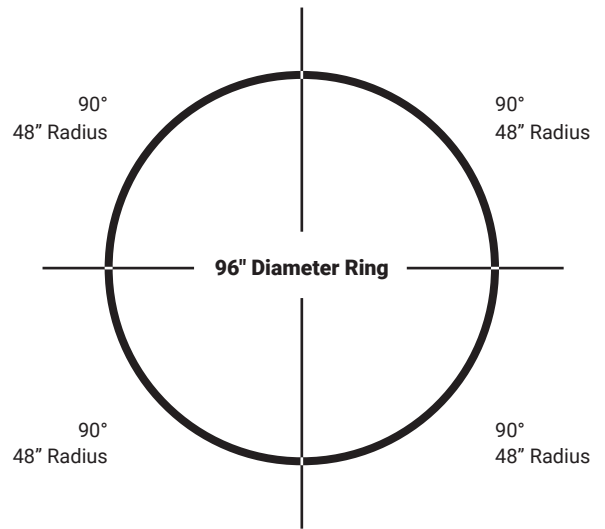
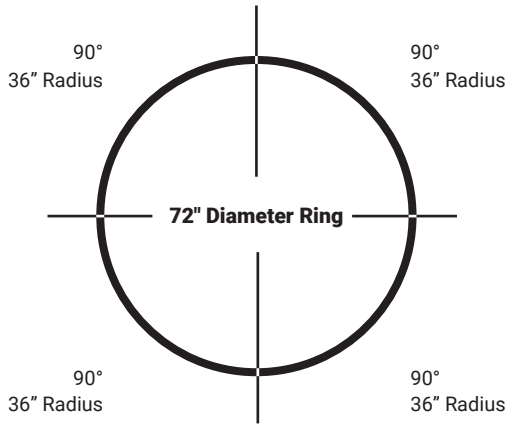

30 Degrees **Custom radii and degrees available**

Part# 30SOUL-R24

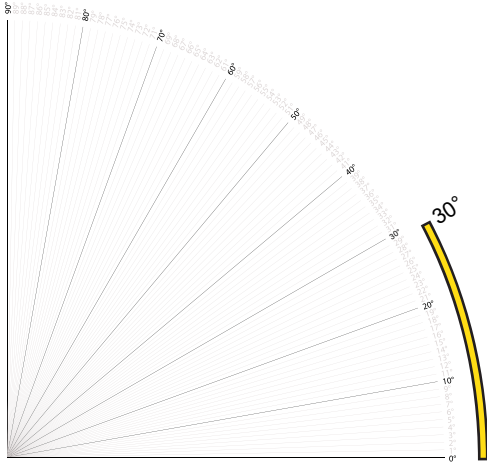
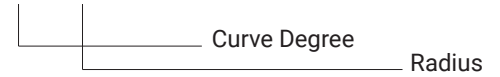

30 Degrees

A. Curve length / B. Chord Length / C. Radius

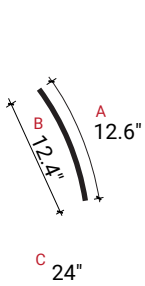

30SOUL-R24

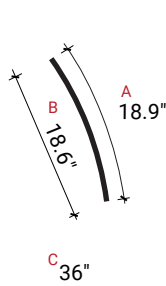

30SOUL-R36

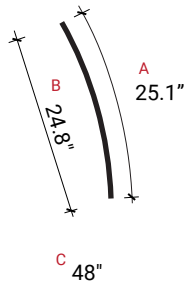

30SOUL-R48

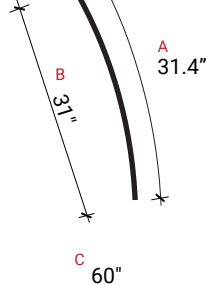

30SOUL-R60

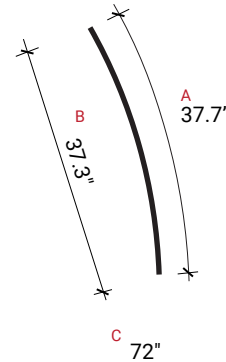

30SOUL-R72

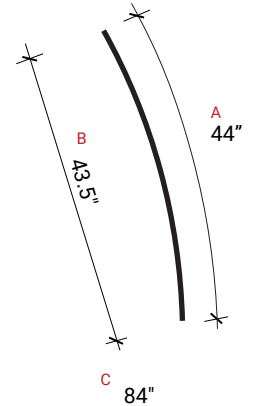

30SOUL-R84

45 Degrees **Custom radii and degrees available**

Part# 45SOUL-R24

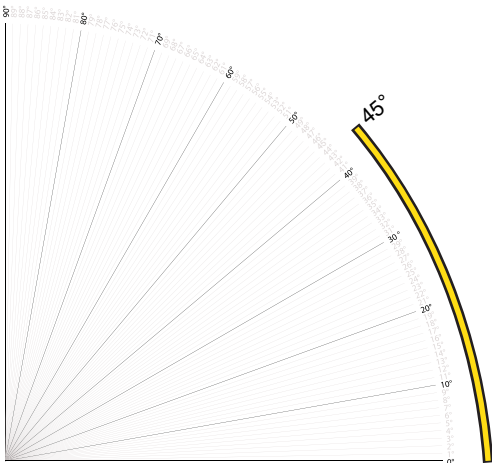
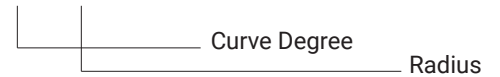

45 Degrees

A. Curve length / B. Chord Length / C. Radius

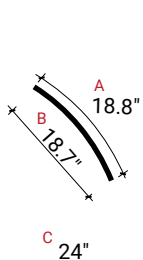

45SOUL-R24

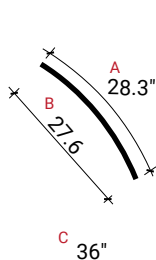

45SOUL-R36

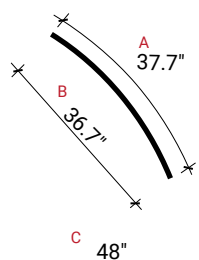

45SOUL-R48

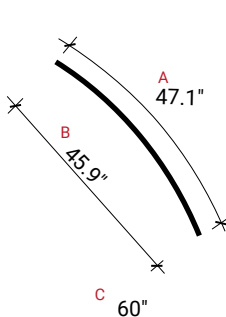

45SOUL-R60

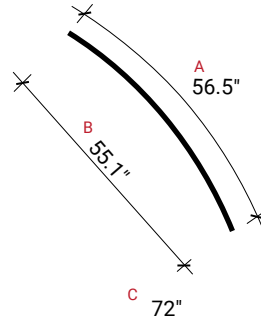

45SOUL-R72

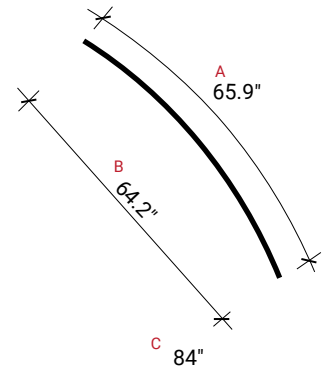

45SOUL-R84

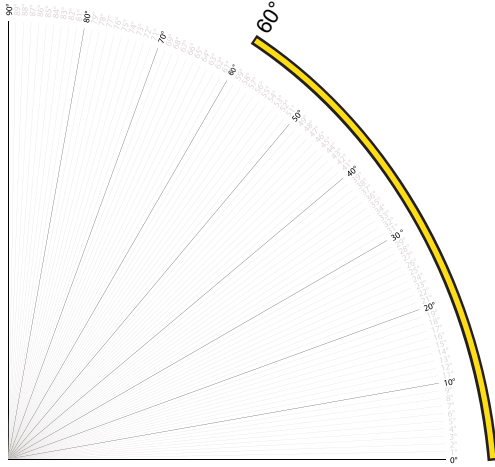

60 Degrees Custom radii and degrees available

Part# 60SOUL-R24



60 Degrees
A. Curve length / B. Chord Length / C. Radius

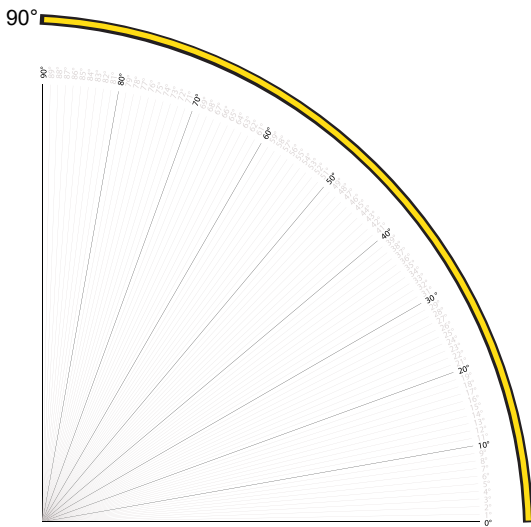
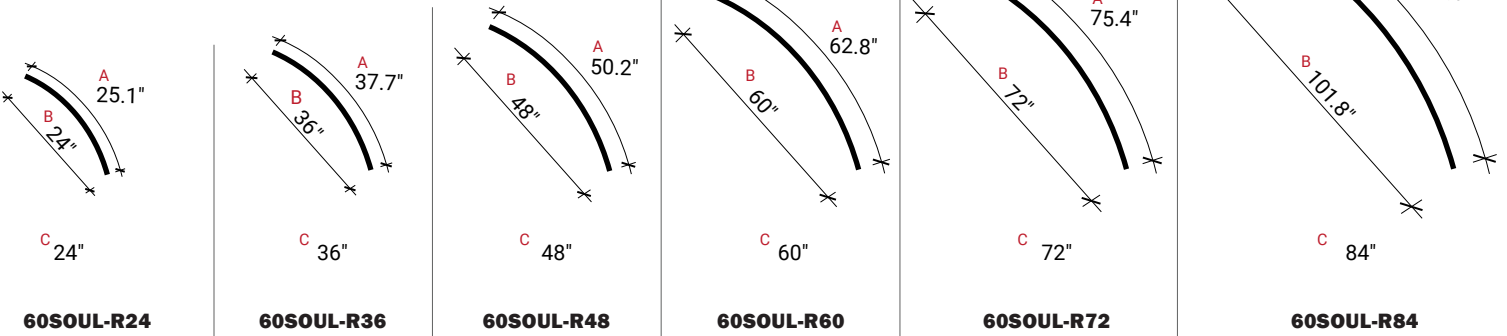

90 Degrees Custom radii and degrees available

Part# 90SOUL-R24

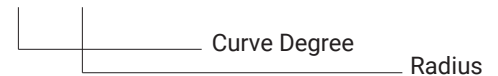

90 Degrees
A. Curve length / B. Chord Length / C. Radius

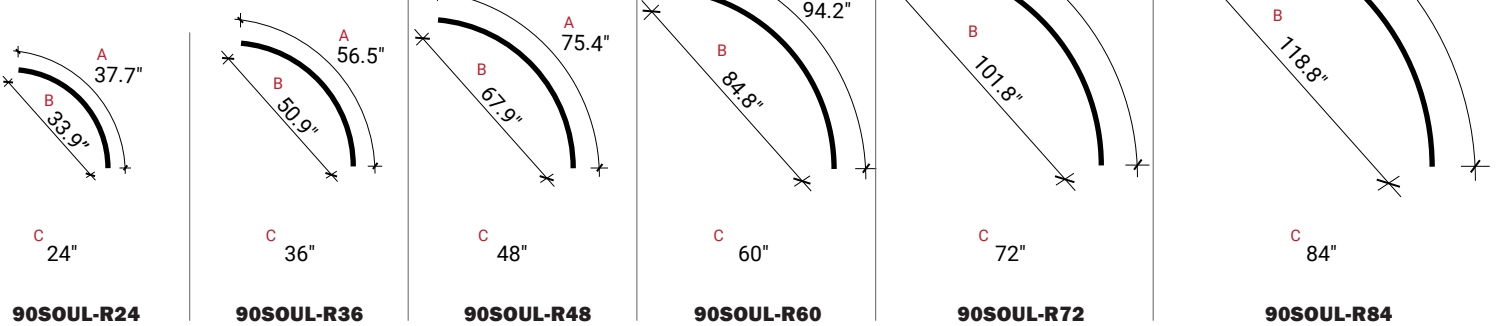

120 Degrees Custom radii and degrees available

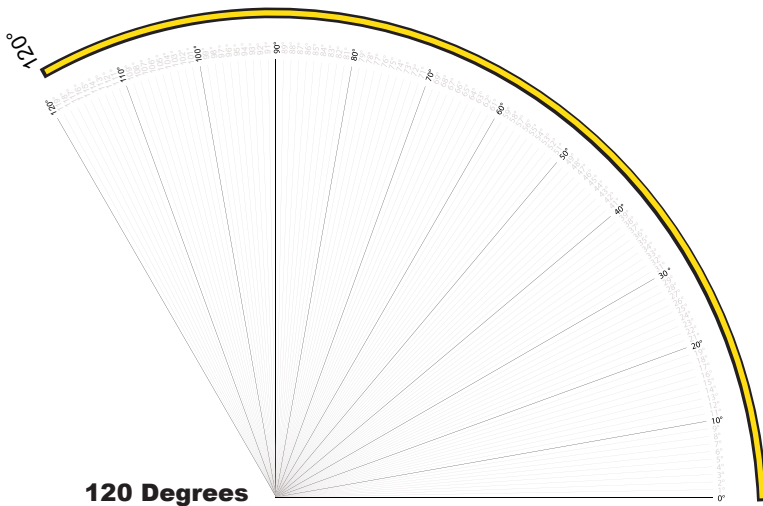

120 Degrees
A. Curve length / B. Chord Length / C. Radius

Part# 120SOUL-R24

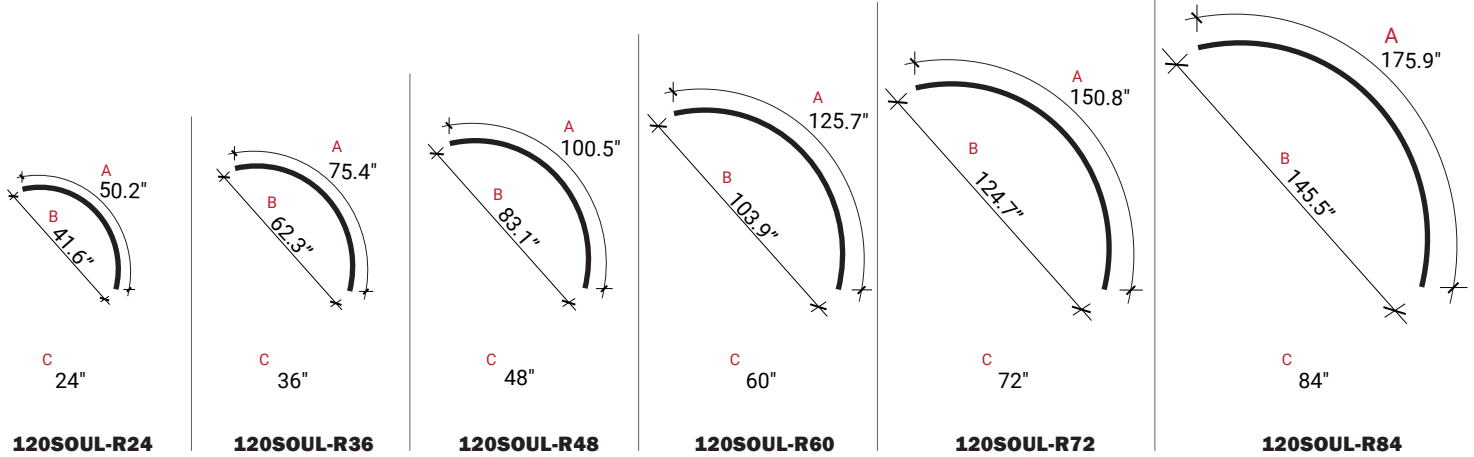
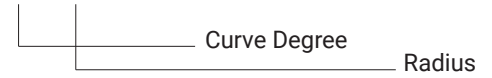

Straight Runs

Custom straight runs are available in increments of 1 inch

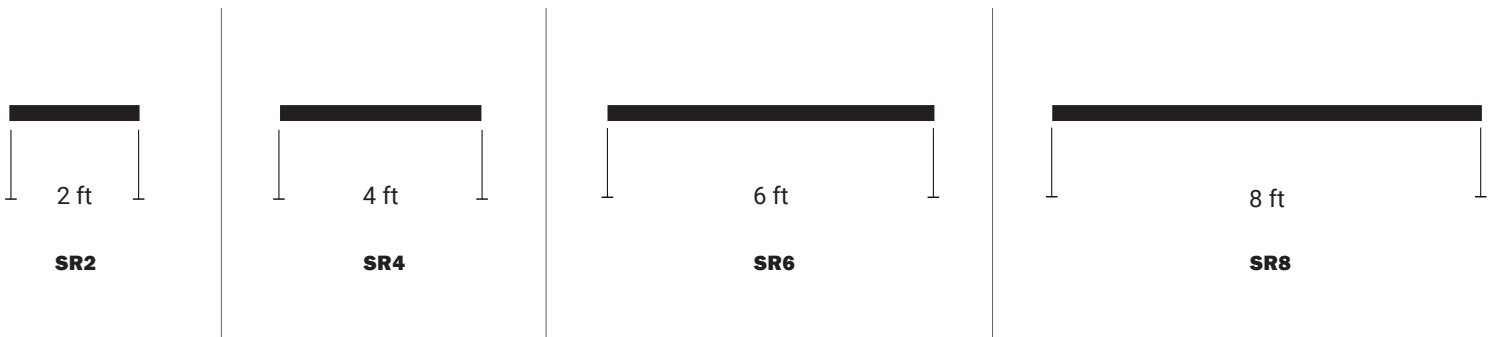

Curved Joiners

Curved joiners are essential for connecting arcs, curves, and continuous lengths. These joiners facilitate the creation of a variety of shapes with a rounded finish.

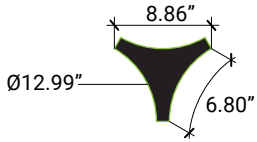

JY-SOUL1
Y-Shaped Joiner

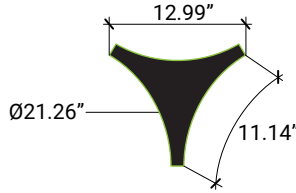

JY-SOUL2
Y-Shaped Joiner

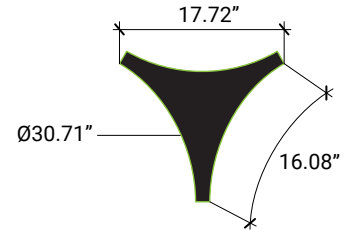

JY-SOUL3
Y-Shaped Joiner

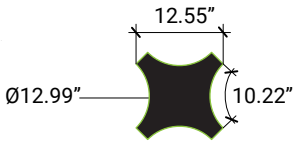

JX-SOUL1
X-Shaped Joiner

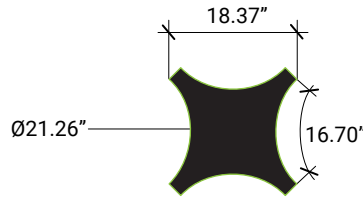

JX-SOUL2
X-Shaped Joiner

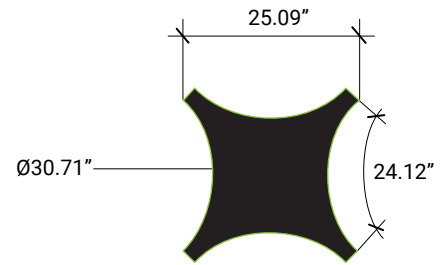

JX-SOUL3
X-Shaped Joiner

Samples

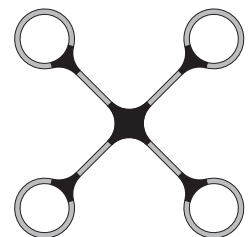
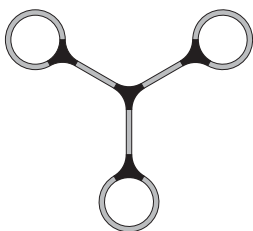

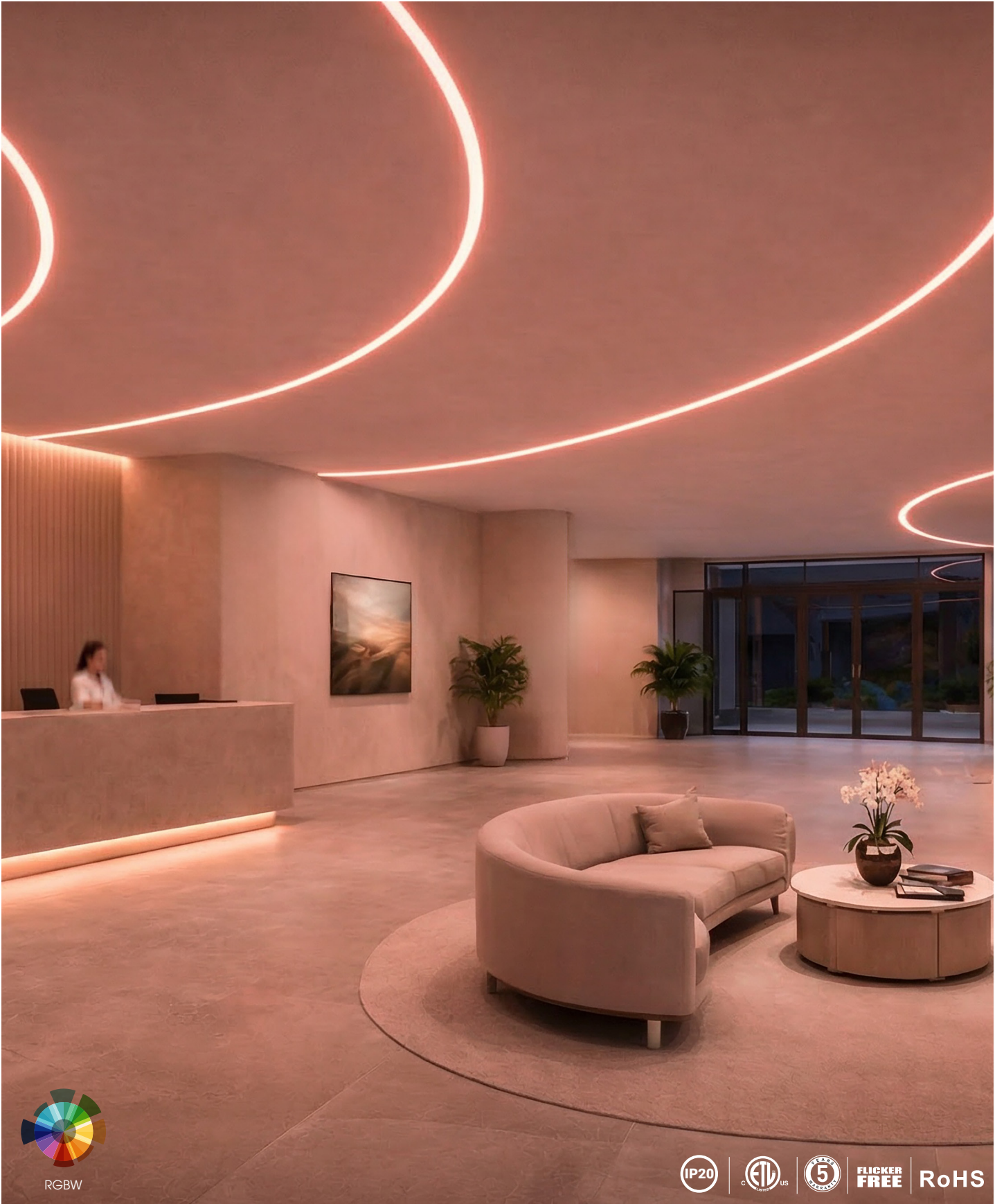

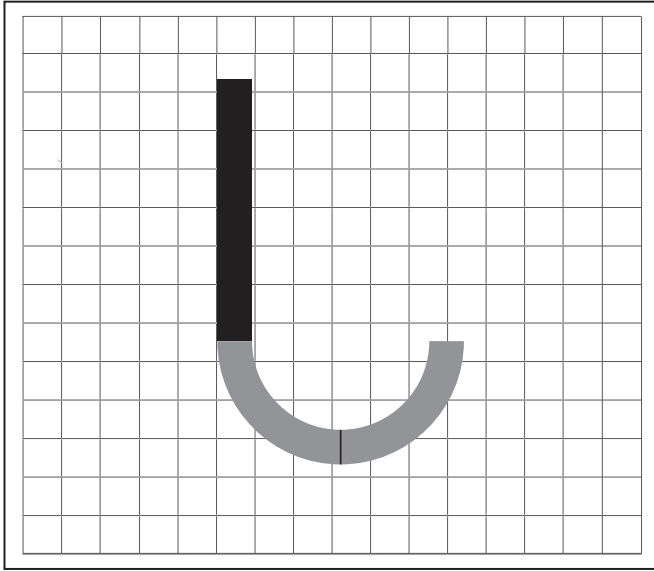

How to **design** **your** OWN shapes!

1. Select the pieces you want to use to build the fixture and draw them on the grid. Refer to pages 4, 5, 6, and 7 to choose the desired pieces.
2. After drawing the fixture on the grid, send the design to yuchen@iuseelite.com
3. Once you approve the design, we will bring it to life.

PRACTICE!

Take a look at pages 4, 5, 6, and 7 and see if you can figure out which parts were used to assemble this luminaire.

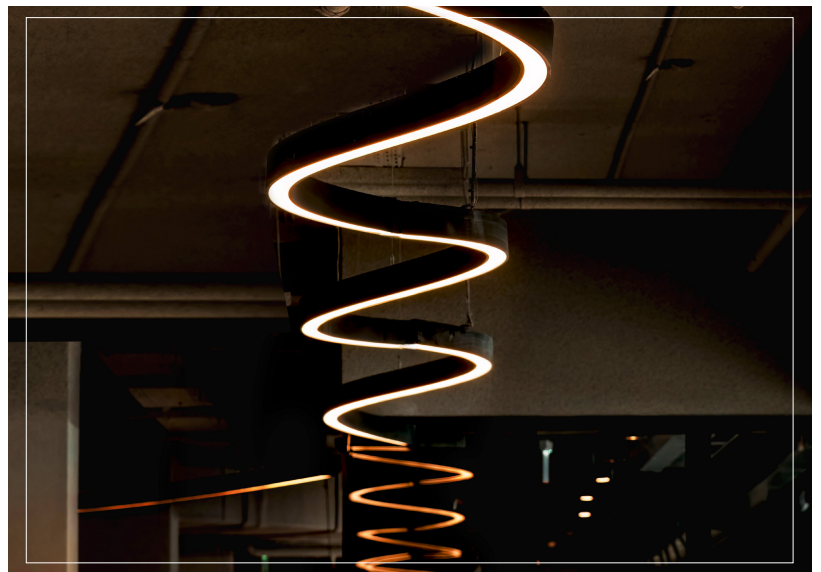
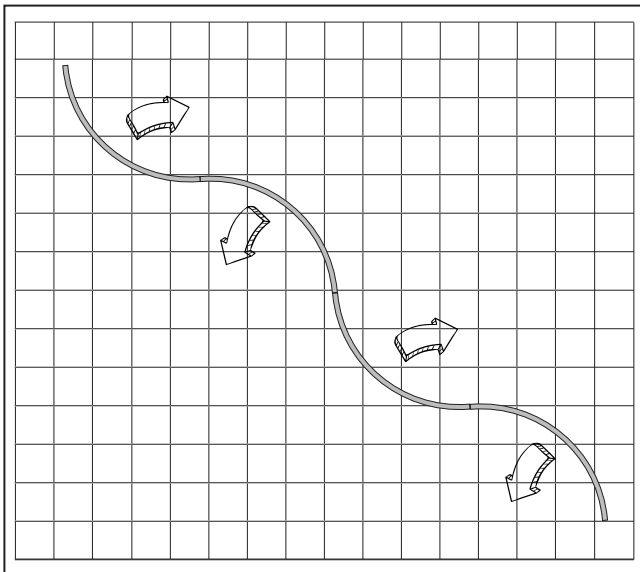

Image shown: Suspended wave luminaire. Wave shapes can also be installed as recessed mounts.

Curve Radius Part# _____

Straight Runs Part# _____

Luminaire Configuration Guide

SR—Straight Runs:

2 ft, 4 ft, 6 ft, 8 ft, Custom

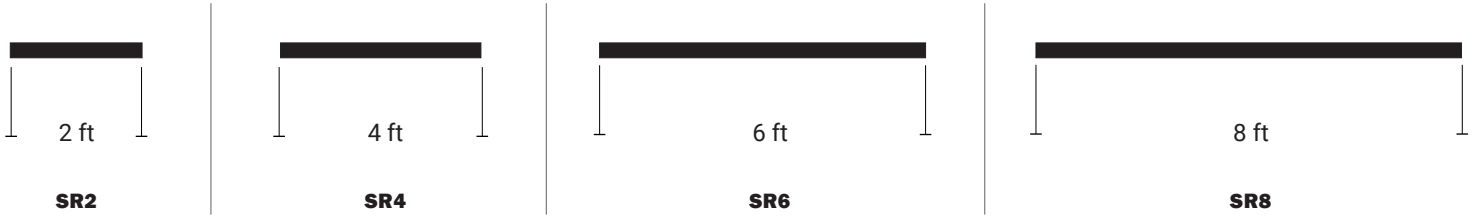

DC—DEGREE OF CURVE:

30°, 45°, 60°, 90°, 120°, Custom

R—CURVE RADIUS:

24", 36", 48", 60", 72", 84", Custom

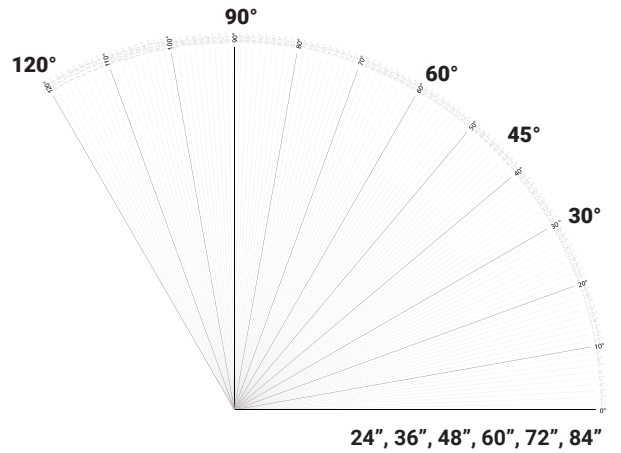

Be Inspired

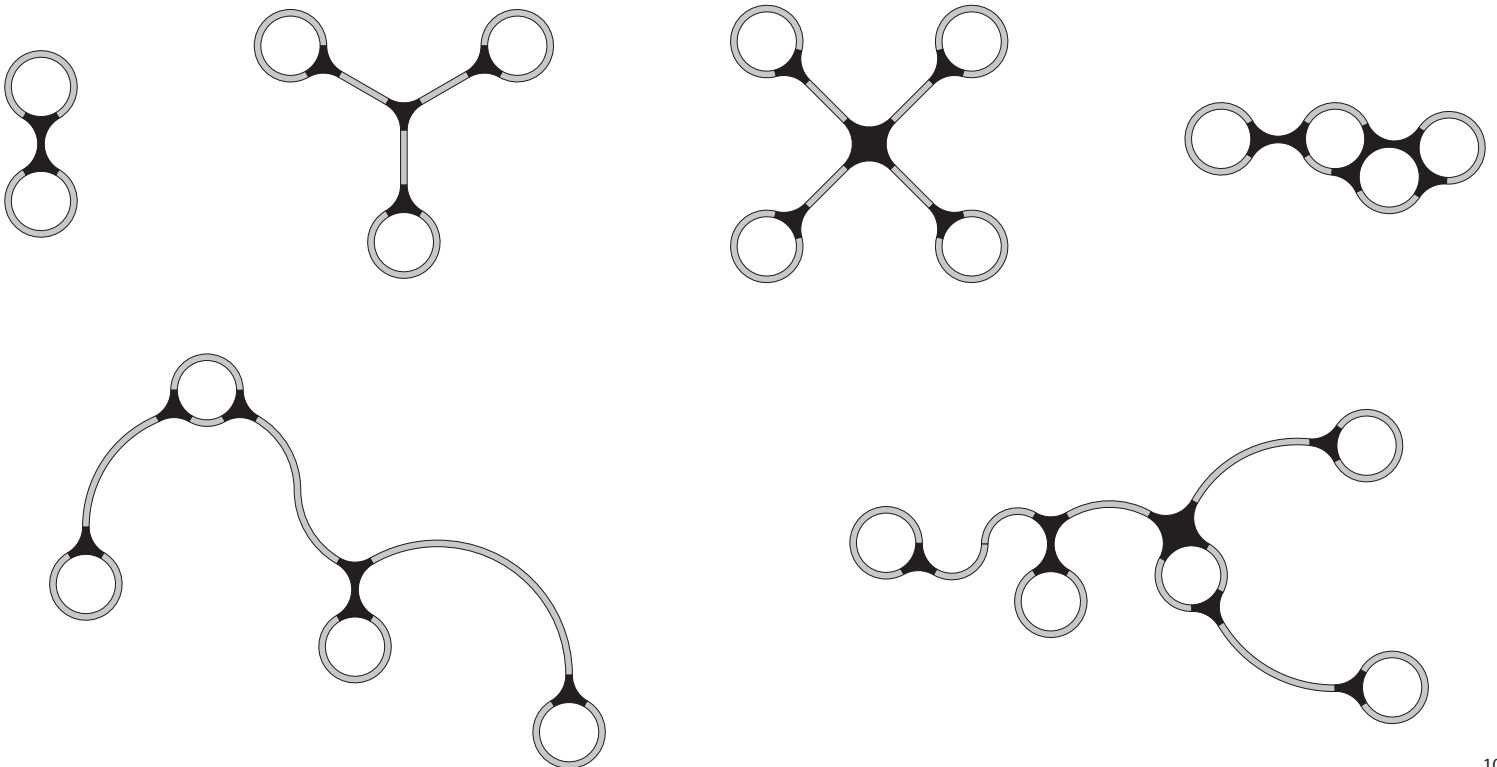

ORDERING TABLE

Example: SOULMATE-RGBW-RTM-2-CUS-D500L-1C-REM-DMX512-RDM-MVOLT-90-WH

SERIES	SIZE	² SHAPE	LUMENS / DIRECT	DISTRIBUTION	NUMBER OF CIRCUITS
SOULMATE- RGB W-RTM	¹ 2 - 2.36"x2.95"	CUS - Custom <i>Sketch your design on the next page.</i>	D500L - 500 Lumens Per Ft D750L - 750 Lumens Per Ft	(blank) - Standard	1C 2C

DRIVER MOUNT	DIMMING	VOLTAGE	CRI	FINISH	³ EMERGENCY
REM - Remote Driver	DMX512-RDM - DMX512 & RDM ELDODMX.1 - EldoLED DMX BLE - Wireless Bluetooth Control	MVOLT - 120-277V	90 - 90CRI 95 - 95CRI	WH - White BK - Black SI - Silver RAL - Consult Factory	REM-0-EMG-LED-10W REM-0-EMG-LED-20W

TOTAL RUN / FT & IN

XX.YY.ZZ

XX= Length in Feet
YY= Fraction in Inches
ZZ= Fractions of an Inch
e.g. 22 ft. 6 in. 1/2 in

1. W 2.36" × H 2.95" (3.94" flange-to-flange)
2. Please refer to the next page and sketch your design on the grid. Afterward, email it to yuchen@iuseelite.com with any required details
3. Remote emergency option available, please consult factory



Sketch your design using the grid space below and email it to yuchen@iuseelite.com



Square



Rectangle



Ring



Oval



Free Pattern