

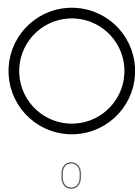

INTRODUCING

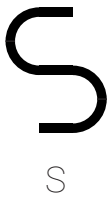

SOUL Essential Shapes – is a versatile Free-Form Shape LED luminaire that brings spirit, energy, and action to large space environments. SOUL harnesses the flexibility and creativity of a tapelight while maintaining the quality and durability of a solid luminaire; designed to simultaneously enhance creativity and functionality in a space, this unique fixture comes in separate pieces which join to create various flowing, long running, free-form and round-edge shapes, including squares and rectangles, circles, ovals, and S, O, U, and L.

Available with surface mount, ceiling mount, suspended mount, and wall mounting options, in a standard width of 2.3", in various lengths and angles that allow for playful design. Capable of max. continuous runs of 8 feet and ideal for adding an element of originality to corporate offices, educational, commercial, and retail spaces.

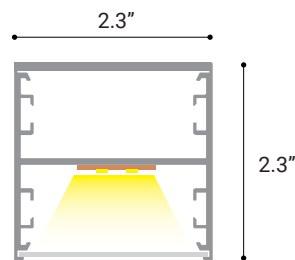

Size

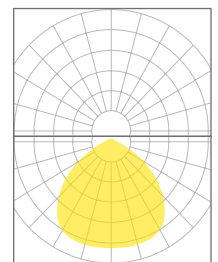

Ligth Distribution

OPTICS & PERFORMANCE

This item's high-efficiency LED optical system includes a precision-cut acrylic lens with a smooth frosted finish for glare-free, even illumination and reflective sidewalls that help distribute the LED light evenly across the acrylic-surface. The lens features a snap-in design that fits securely into the groove of the fixture's body, making it easy to remove for access to the LED driver and LED board. This SOUL-LED fixture can be customized into various shapes by assembling different angles and degrees to meet diverse architectural needs.

CONSTRUCTION

Body constructed from up to 90% recyclable, extruded architectural-grade 6063 aluminum with a minimum wall thickness of 0.075", to ensure durability and sustainability. Lenses are made from twin-layered, extruded high-impact acrylic, with a maximum single length of 8 ft.

DISTRIBUTION PATTERNS & DIFFUSER

Features an optically extruded, high-impact acrylic lens for a uniform, smooth illumination with reduced glare and precise light output control. Lens designed to snap securely into the housing and integrate seamlessly with the fixture, to ensure a refined and clean appearance.

CRM INSTALLATION

Lighting design will adhere to the factory shop drawing. For continuous mounting, the first section will always include the power supply feed. Housing connections will feature a joint bracket and a male/female connector for electrical connections. For special mounting requirements, please follow the provided mounting instructions.

CEILING MOUNT

For a ceiling mounted version of SOUL Essential Shapes, luminaire must be installed directly into the ceiling with screws, sans mounting bracket. Large designs may be mounted and assembled simultaneously, by screwing in individual pieces and then joining and screwing them into the ceiling according to the design.

LED DYNAMIC PLATFORM OPTIONS

Luminaires using RGB+White Color Tuning Technology have a color tuning range of 6000-1650 (RGBW- 60K-16K) using ELITE platform components. Light can be dimmed from 100-0.1% while maintaining constant CCT. Gradients of saturated colors from 0.1-100% can be added to color points within the tuning range to change a spaces' atmosphere by manipulating the color temperature of the room to add exciting contrast, mimic natural light cues, and affect ambiance and human circadian rhythms.

DIMMING & DRIVER INFORMATION

ELDODMX.1 - EldoLED PowerDrive dimming down to 0.1%.

DMX512 & RDM - 120-277V LED Driver

BLE - Luminaires may be controlled, grouped, scheduled or placed in scenes and or zones or both, via Cassambi Bluetooth 4.0 App.

FINISH

Standard color - White / Black / Anodized aluminum.
RAL CLASSIC COLORS.

WARRANTY

Five-year warranty for parts and components.(Labor not included).

LISTINGS

cETLus - Listed

RoHS - Contains no mercury or lead and RoHS compliant

TECHNICAL DETAILS



INPUT VOLTAGE	120-277V
POWER	6W/ft, 9W/ft
EFFICIENCY LM/W	80Lm/W
LUMENS PER FOOT	500L, 750L
CRI	90+, 95+
LIGHT DISTRIBUTION	Direct
CCT	RGBW (35K standard option)
SHAPES	S, O, U, L, Free Pattern

MOUNTING	Ceiling Mount
SIZE	W2.3" x H2.3"
CURVE DEGREES	30°, 45°, 60°, 90°, 120° Custom Degrees Available.
CURVE RADIUS	24", 36", 48", 60", 72", 84" Custom Radius Available.
CONTINUOUS LENGTHS	2 ft, 4 ft, 6 ft, 8 ft Custom Lengths Available.
COLOR	White, Black, Silver, Custom RAL
DIMMING & CONTROLS	ELDODMX.1, DMX512 & RDM, BLE.
EMERGENCY	Remote Emergency Option. Consult Factory

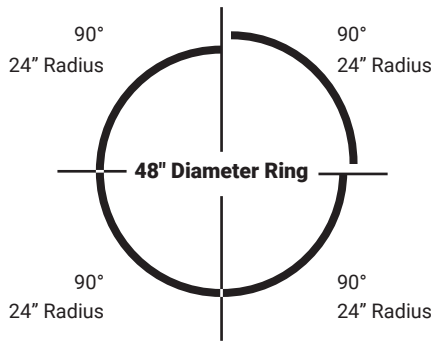

Ring Diameters

Made by individual segments

Radius of Each Segment: There are four, 90-degree segments, each with a radius of 24 inches.

Complete Circle: Four 90-degree segments come together to form a complete circle (360 degrees).

Diameter Calculation: The diameter of a circle is twice the radius. So, with a radius of 24 inches:

Diameter= 2×Radius=2×24=48inches

The diameter of the fixture ring is 48 inches.

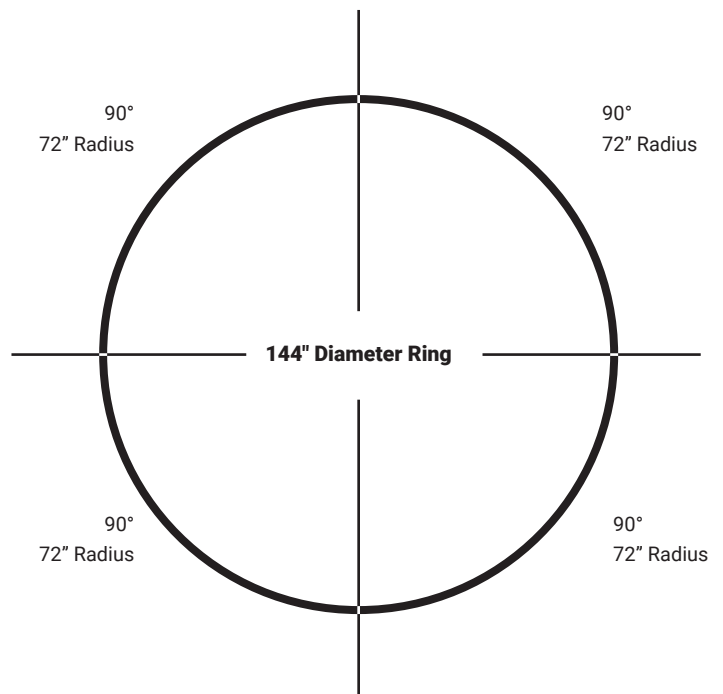
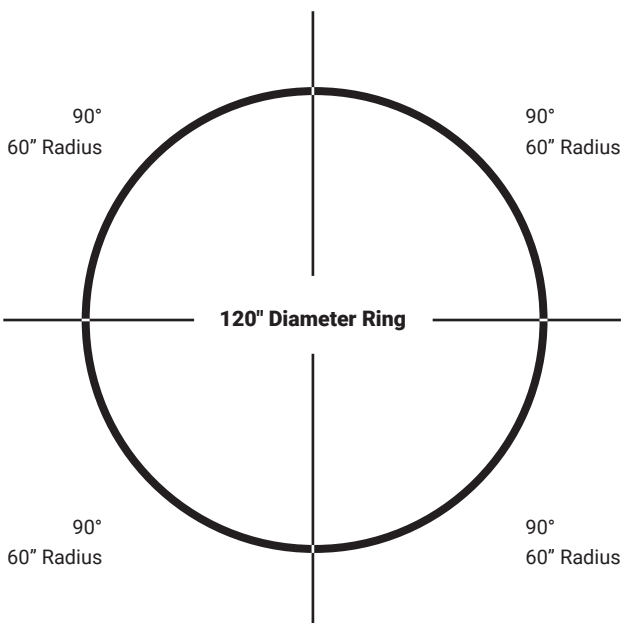
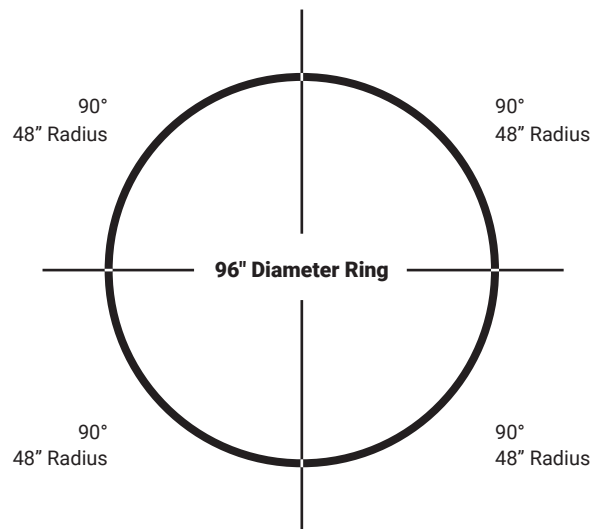
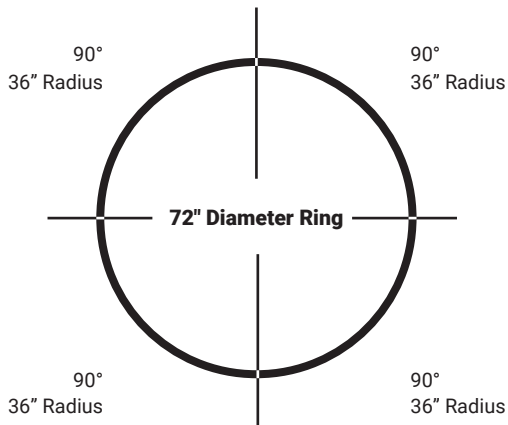

30 Degrees **Custom radii and degrees available**

Part# 30SOUL-R24

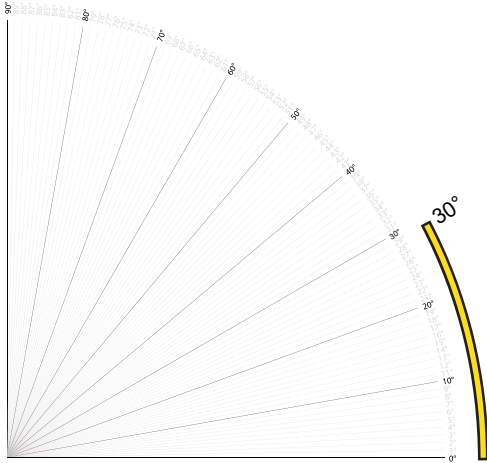
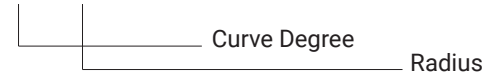

30 Degrees

A. Curve length / **B.** Chord Length / **C.** Radius

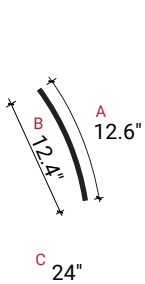

30SOUL-R24

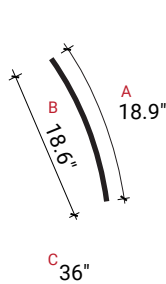

30SOUL-R36

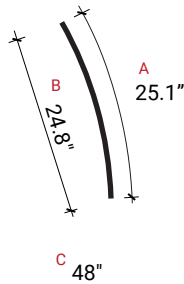

30SOUL-R48

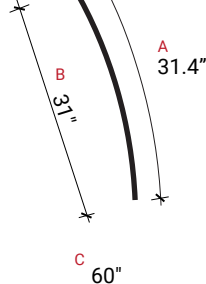

30SOUL-R60

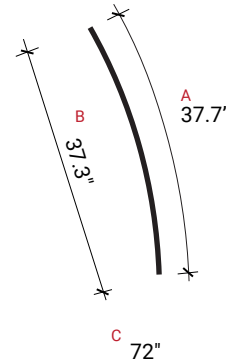

30SOUL-R72

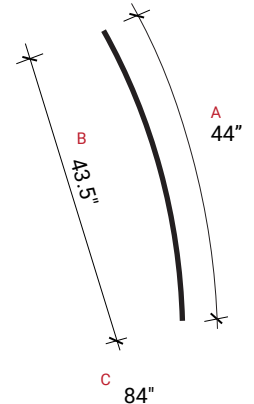

30SOUL-R84

45 Degrees **Custom radii and degrees available**

Part# 45SOUL-R24

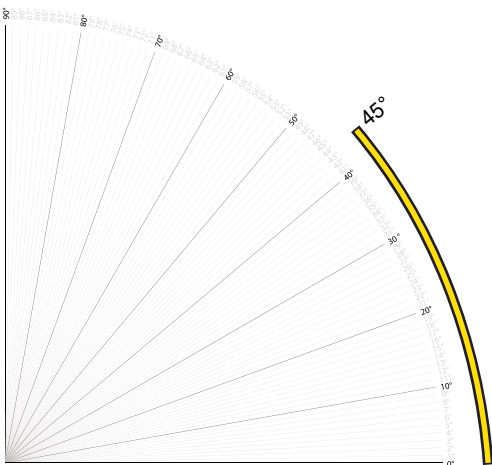
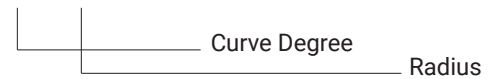

45 Degrees

A. Curve length / **B.** Chord Length / **C.** Radius

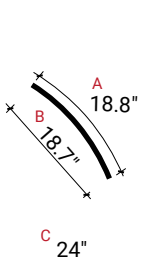

45SOUL-R24

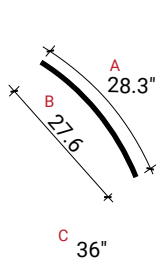

45SOUL-R36

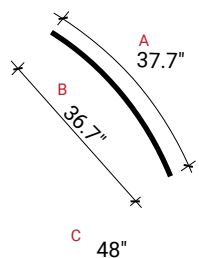

45SOUL-R48

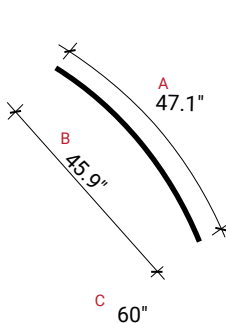

45SOUL-R60

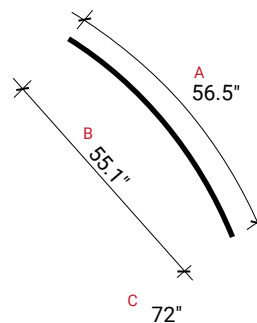

45SOUL-R72

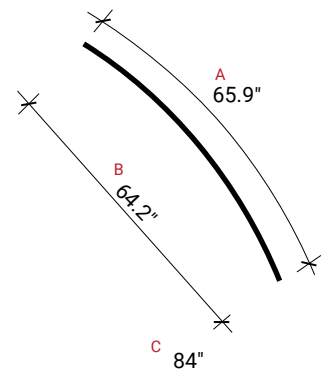

45SOUL-R84

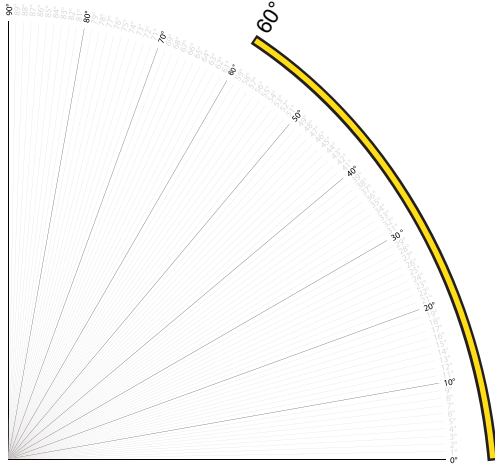

60 Degrees
 A. Curve length / B. Chord Length / C. Radius

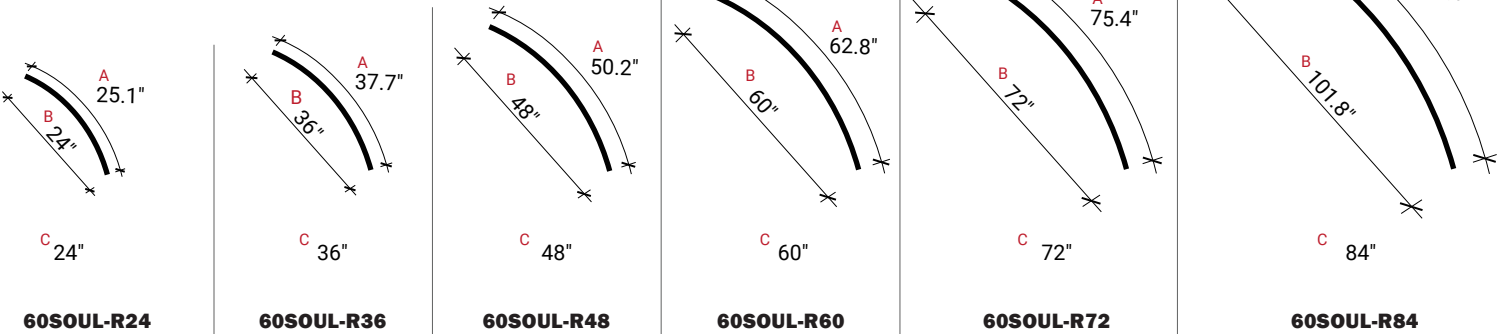

60 Degrees Custom radii and degrees available

Part# 60SOUL-R24

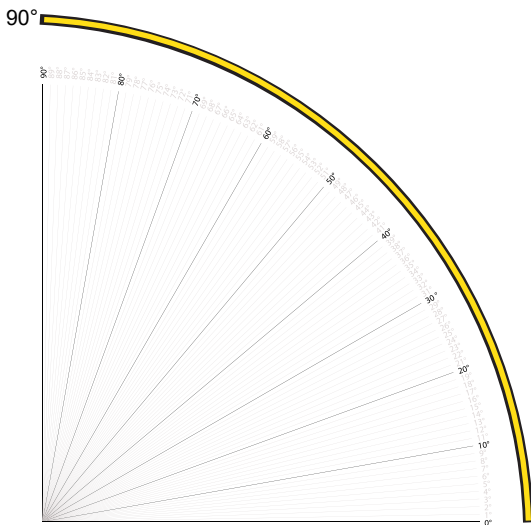
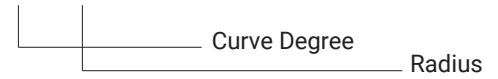

90 Degrees
 A. Curve length / B. Chord Length / C. Radius

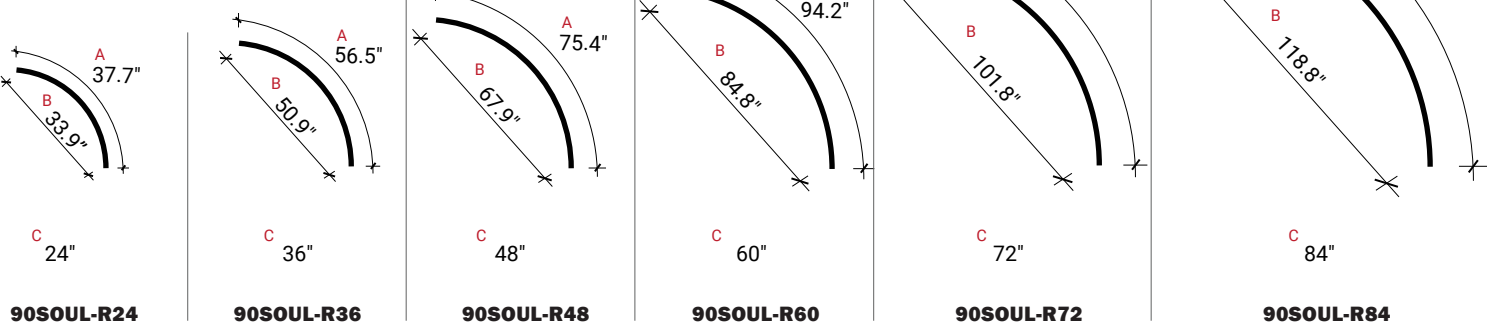

90 Degrees Custom radii and degrees available

Part# 90SOUL-R24

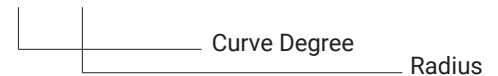

120 Degrees Custom radii and degrees available

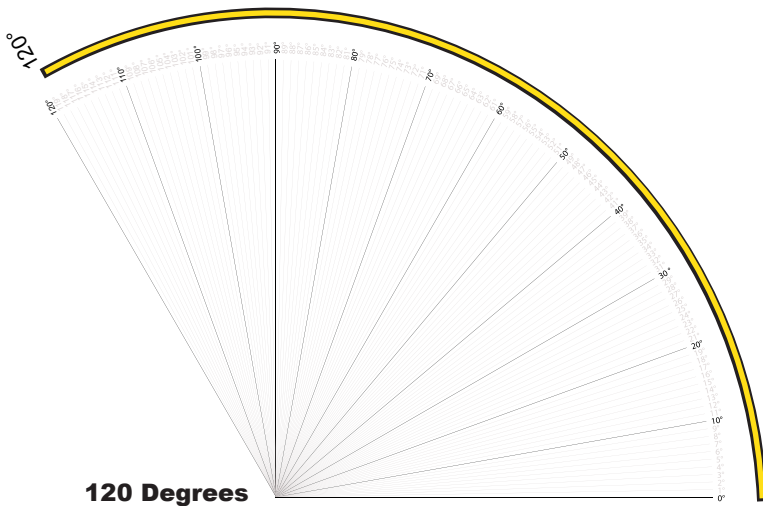

120 Degrees
A. Curve length / B. Chord Length / C. Radius

Part# 120SOUL-R24

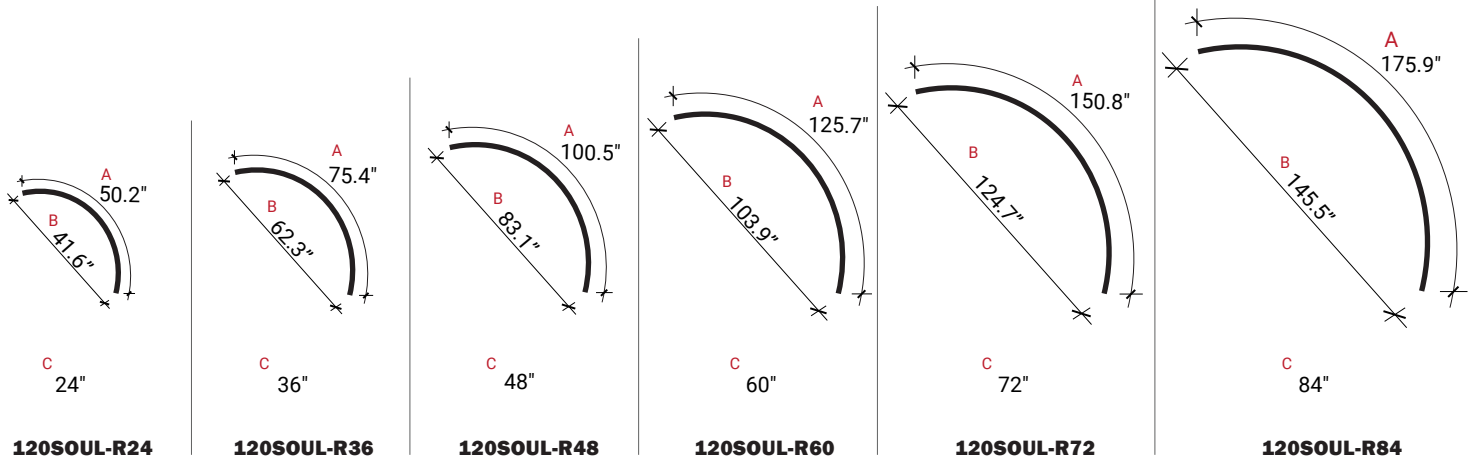
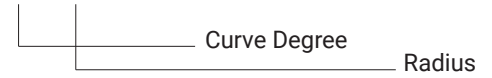

Straight Runs

Custom straight runs are available in increments of 1 inch

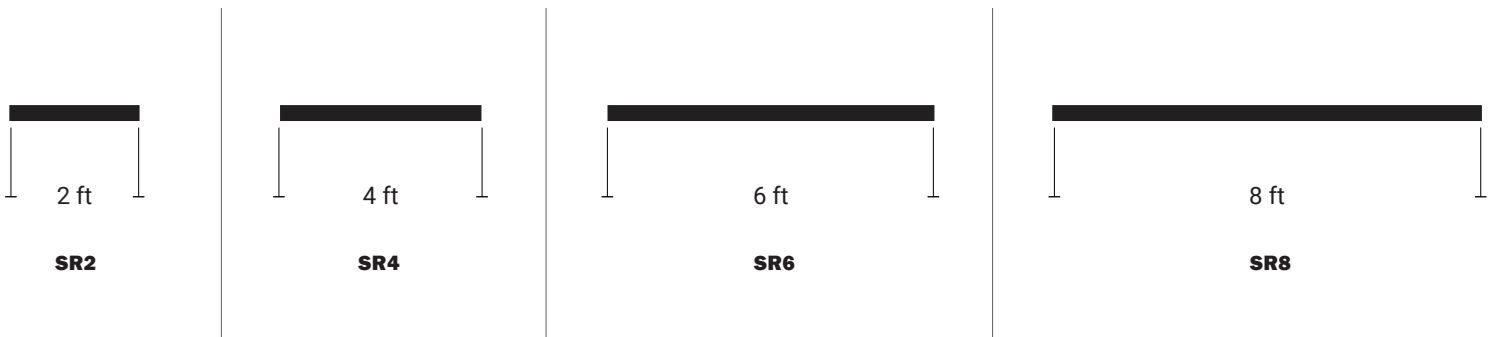

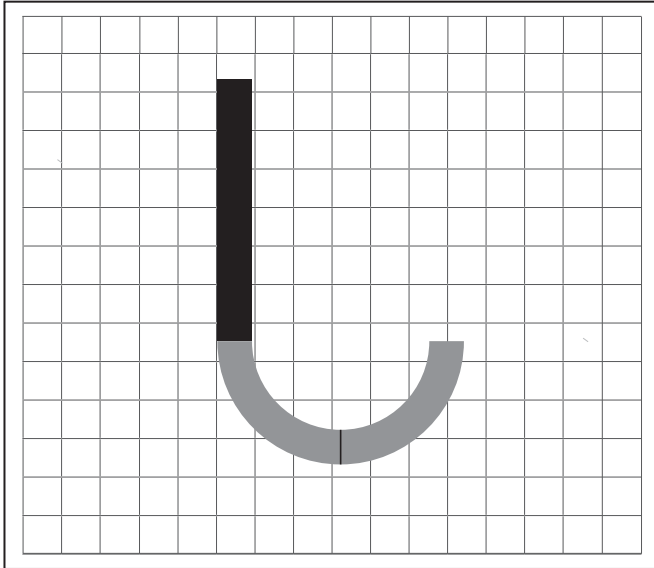

How to **design** **your** OWN shapes!

1. Select the pieces you want to use to build the fixture and draw them on the grid. Refer to pages 4, 5, and 6 to choose the desired pieces.
2. After drawing the fixture on the grid, send the design to yuchen@iuseelite.com
3. Once you approve the design, we will bring it to life.

PRACTICE!

Take a look at pages 4, 5, and 6 and see if you can figure out which parts were used to assemble this luminaire.

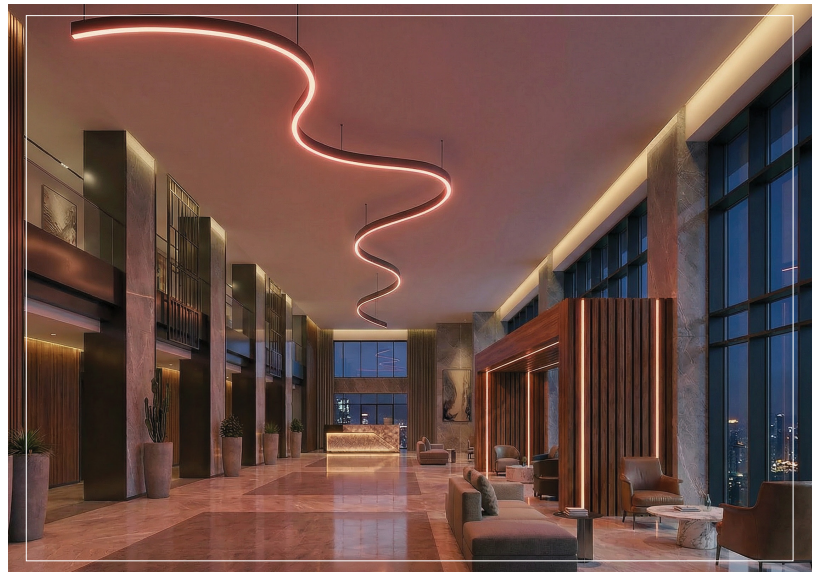
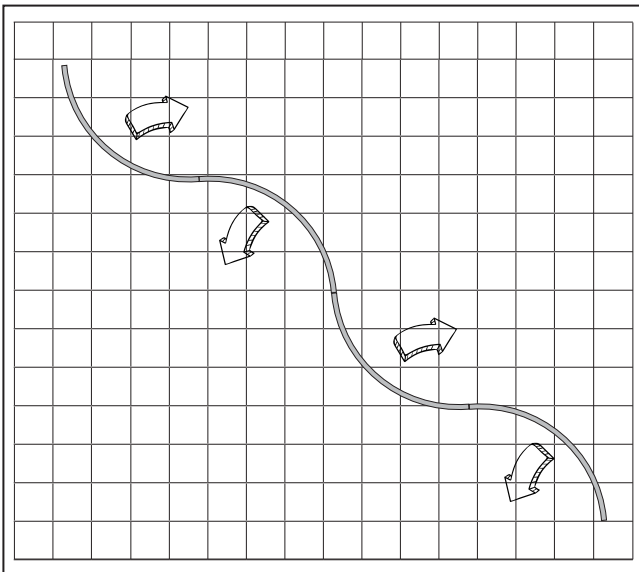

Image shown: Suspended wave luminaire. Wave shapes can also be installed as ceiling mounts.

Curve Radius Part# _____

Straight Runs Part# _____

Luminaire Size Configurator (Sample)

Specify the length of the 'SR' straight run, as well as the curve degree and curve radius.

Example: **Part# SR4**

Part# 90SOUL-R36

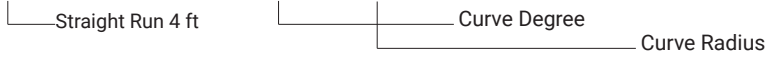

<p>Total Run 30ft and 8"</p> <p>S-Shape</p>	<p>Total Run 25ft</p> <p>O-Shape</p>	<p>Total Run 18ft and 3"</p> <p>U-Shape</p>	<p>Total Run 16ft and 8.5"</p> <p>L-Shape</p>
---	--	---	---

<p>Total Run 39ft and 2"</p> <p>OV-Oval Shape</p>

Luminaire size Configurator

<p>Total Run <input type="text"/></p> <p>S-Shape</p>	<p>Total Run <input type="text"/></p> <p>O-Shape</p>	<p>Total Run <input type="text"/></p> <p>U-Shape</p>	<p>Total Run <input type="text"/></p> <p>L-Shape</p>
<p>Total Run <input type="text"/></p> <p>OV-Oval Shape</p>	<p>Custom: Draw your own shape on the last page.</p> <p>For assistance with fixture configuration, please contact yuchen@iuseelite.com</p>		

ORDERING TABLE

Example: SOUL-RGBW-CM-2-S-D500L-1C-REM-DMX512-RDM-MVOLT-95-BK

SERIES	WIDTH	¹ SHAPE	LUMENS / DIRECT	DISTRIBUTION	NUMBER OF CIRCUITS
SOUL-RGBW-CM	2 - 2.3"x2.3"	S - S O - O U - U L - L OV - Oval ² CUS - Custom	D500L - 500 Lumens Per Ft D750L - 750 Lumens Per Ft	(blank) - Standard	1C 2C

DRIVER MOUNT	DIMMING	VOLTAGE	CRI	FINISH	³ EMERGENCY
REM - Remote Driver	DMX512-RDM -DMX512 & RDM ELDODMX.1 -EldoLED DMX BLE -Wireless Bluetooth Control	MVOLT - 120-277V	90 - 90CRI 95 - 95CRI	WH - White BK - Black SI - Silver RAL - Consult Factory	REM-0-EMG-LED-10W REM-0-EMG-LED-20W

TOTAL RUN / FT & IN
XX.YY.ZZ

XX= Length in Feet
 YY= Fraction in Inches
 ZZ= Fractions of an Inch
 e.g. 22 ft. 6 in. 1/2 in

1. Please refer to the next page for the Chart of Curve Degree, Curve Length, Radius, and Straight Run sizes to build your luminaire.
2. Sketch your design on the grid provided on the last page and email it to yuchen@iuseelite.com
3. Remote emergency option available, please consult factory.

CHART

Curve Degree, Curve Radius, Curve Length, and Straight Runs

Curve Degree: 30°, 45°, 60°, 90°, 120°, Custom

Curve Radius: 24", 36", 48", 60", 72", 84", Custom

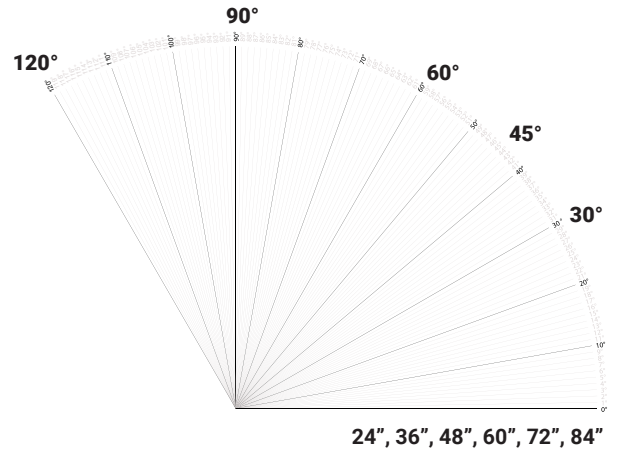

CURVE	RADII	CURVE LENGTH	STRAIGHT RUN
30°	24"	12.6"	2 ft 4 ft 6 ft 8 ft
	36"	18.9"	
	48"	25.1"	
	60"	31.4"	
	72"	37.7"	
84"	44"		

CURVE	RADII	CURVE LENGTH	STRAIGHT RUN
45°	24"	18.8"	2 ft 4 ft 6 ft 8 ft
	36"	28.3"	
	48"	37.7"	
	60"	47.1"	
	72"	56.5"	
84"	65.9"		

CURVE	RADII	CURVE LENGTH	STRAIGHT RUN
60°	24"	25.1"	2 ft 4 ft 6 ft 8 ft
	36"	37.7"	
	48"	50.2"	
	60"	62.8"	
	72"	75.4"	
84"	113.1"		

CURVE	RADII	CURVE LENGTH	STRAIGHT RUN
90°	24"	37.7"	2 ft 4 ft 6 ft 8 ft
	36"	56.5"	
	48"	75.4"	
	60"	94.2"	
	72"	113.1"	
84"	131.9"		

CURVE	RADII	CURVE LENGTH	STRAIGHT RUN
120°	24"	50.2"	2 ft 4 ft 6 ft 8 ft
	36"	75.4"	
	48"	100.5"	
	60"	125.7"	
	72"	150.8"	
84"	175.9"		



Image shown: Suspended wave luminaire. Wave shapes can also be installed as ceiling mounts. 11.



Sketch your design using the grid space below and email it to yuchen@iuseelite.com



S



O



U



L



Free Pattern

