

Tunable White



FLICKER FREE

RoHS

INTRODUCING

SOUL Geometric Shapes

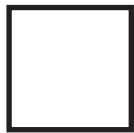

Square



Rectangle



Hexagon



Triangle

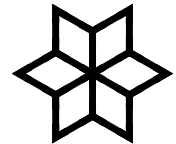

Free Pattern

SOUL Geometric Shapes — is a versatile Free-Form Shape LED luminaire inspired by ancient Peruvian Nazca lines. SOUL-GEOMETRIC brings spirit, energy, and action to large space environments, harnessing the flexibility and creativity of a tapelight while maintaining the quality and durability of a solid luminaire. Designed to simultaneously enhance creativity and functionality in a space, this unique fixture comes in separate pieces which join to create geometric shapes like squares, rectangles, hexagons, and triangles that act as building blocks for various flowing, long running, intricate designs.

Available with surface mount, recessed trimless mount, suspended mount, and wall mounting options, in a standard width of 2.3". Capable of max. continuous runs of 8 feet and ideal for creating patterned, dynamic luminaires that add an element of originality to corporate offices, educational, commercial, and retail spaces.

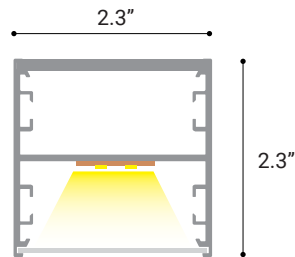

Size

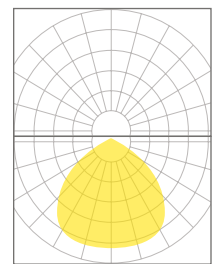

Ligh Distribution

OPTICS & PERFORMANCE

This item's high-efficiency LED optical system includes a precision-cut acrylic lens with a smooth frosted finish for glare-free, even illumination and reflective sidewalls that help distribute the LED light evenly across the acrylic-surface. The lens features a snap-in design that fits securely into the groove of the fixture's body, making it easy to remove for access to the LED driver and LED board. This SOUL-LED fixture can be customized into various shapes by assembling different angles and degrees to meet diverse architectural needs.

CONSTRUCTION

Body constructed from up to 90% recyclable, extruded architectural-grade 6063 aluminum with a minimum wall thickness of 0.075", to ensure durability and sustainability. Lenses are made from twin-layered, extruded high-impact acrylic, with a maximum single length of 8 ft.

DISTRIBUTION PATTERNS & DIFFUSER

Features an optically extruded, high-impact acrylic lens for a uniform, smooth illumination with reduced glare and precise light output control. Lens designed to snap securely into the housing and integrate seamlessly with the fixture, to ensure a refined and clean appearance.

CRM INSTALLATION

Lighting design will adhere to the factory shop drawing. For continuous mounting, the first section will always include the power supply feed. Housing connections will feature a joint bracket and a male/female connector for electrical connections. For special mounting requirements, please follow the provided mounting instructions.

WALL MOUNT

The wall mounted version of SOUL Geometric Shapes mounts directly over a horizontally wall mounted, standard 4-inch electrical box. Its wall bracket design allows for the fixture to be hung while making wiring connections. The power feed is on the left side of each unit, and all sections come pre-wired with push-in connectors for a quick installation. Fixtures can also be joined seamlessly for straight, continuous runs, thanks to a rigid alignment feature.

LED DYNAMIC PLATFORM OPTIONS

Tunable White with Smart White Technology allows for color tuning of the luminaire via various controls. Use Tuneable White to mimic daytime light signals that affect circadian rhythm, aid in sleep, mood, and general well-being while creating perfect custom spaces. Maintains a CRI of 90+ across the tunable range of 6500 to 2700K.

DIMMING & DRIVER INFORMATION

DIM10 - 0-10V dimming on either MVOLT 120, 277. Dimmable down to 1% of initial lumens, standard.

ELDO10.1 - E ldoLED SoloDrive 0-10V. Dimming down to 0.1%. Linear dimming curve.

EldoDALI - DALI DT6, DT8 dimming down to 1%.

ELDODMX.1 - EldoLED PowerDrive dimming down to 0.1%.

BLE - Luminaires may be controlled, grouped, scheduled or placed in scenes and or zones Via Cassambi Bluetooth 4.0 App

FINISH

Standard color - White / Black / Anodized aluminum.
RAL CLASSIC COLORS.

WARRANTY

Five-year warranty for parts and components.(Labor not included).

LISTINGS

cETLus - Listed

RoHs - Contains no mercury or lead and RoHS compliant

TECHNICAL DETAILS



INPUT VOLTAGE	120-277V
POWER	6W/ft, 9W/ft
EFFICIENCY LM/W	100Lm/W
LUMENS PER FOOT	650L, 900L
CRI	90+, 95+
LIGHT DISTRIBUTION	Direct
CCT	6500K - 2700K
SHAPES	Square, Rectangle, Hexagon, Triangle, Free-form Pattern

MOUNTING	Wall Mount
SIZE	W2.3" x H2.3"
CURVE DEGREES	30°, 45°, 60°, 90°, 120° Custom Degrees Available
CURVE RADIUS	24", 36", 48", 60", 72", 84" Custom Radius Available
CONTINUOUS LENGTHS	2 ft, 4 ft, 6 ft, 8 ft Custom Lengths Available.
COLOR	White, Black, Silver, Custom RAL
DIMMING & CONTROLS	0-10V Flicker Free 1% Dimming (DIM10), ELDO10.1-, ELDODMX.1, ELDODALI.1, BLE.
EMERGENCY	Remote Emergency Option. Consult Factory

Linear Joiners

Linear joiners are essential for connecting straight segments and creating seamless transitions between different sections. These joiners ensure the formation of precise, straight edges and a clean, sharp finish.

Samples

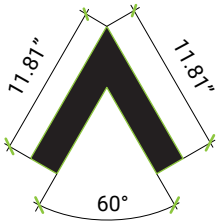
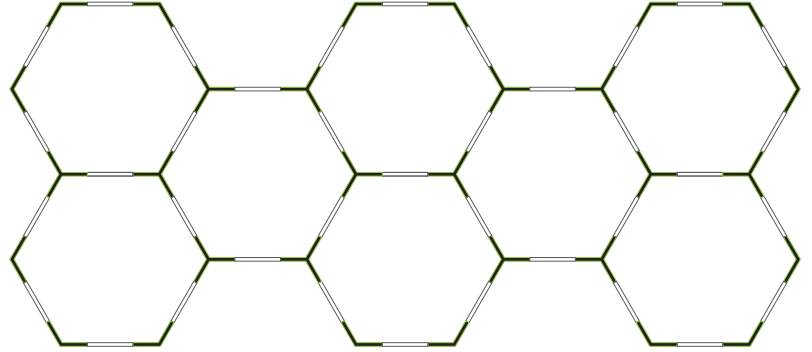
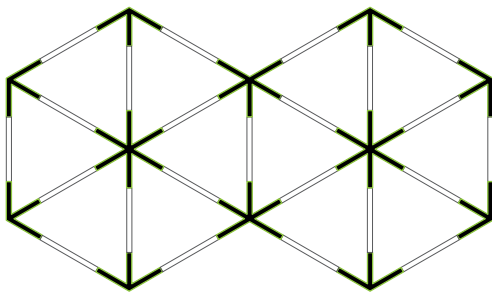

V60J
V60°-Shaped Joiner

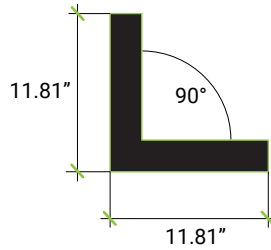

V90J
V90°-Shaped Joiner

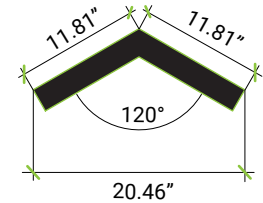

V120J
V120°-Shaped Joiner

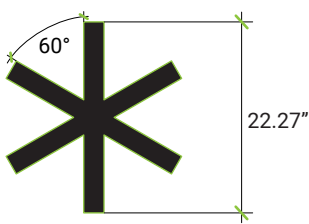

JK-1
Asterisk-Shaped Joiner

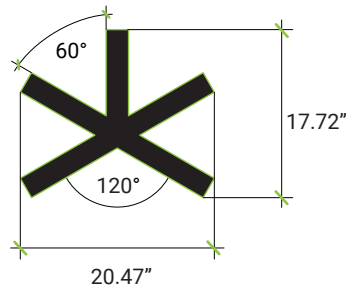

JK-2
Asterisk-Shaped Joiner

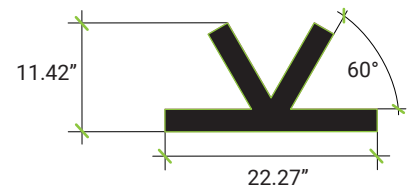

JK-3
Half Asterisk-Shaped Joiner

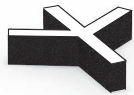
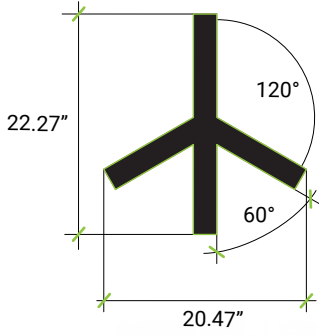

JDY-1
Double Y-Shaped Joiner

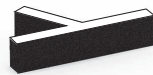
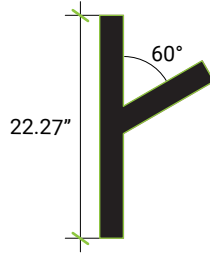

JLY-1
Lowercase y-Shaped Joiner

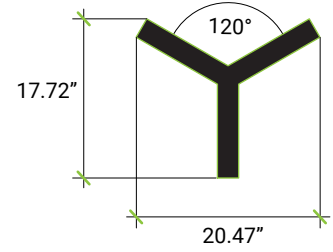

JY-1
Y-Shaped Joiner

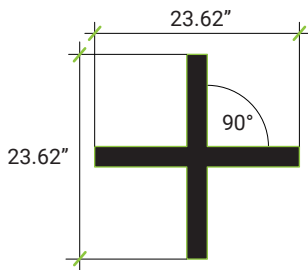

J+-1
+-Shaped Joiner

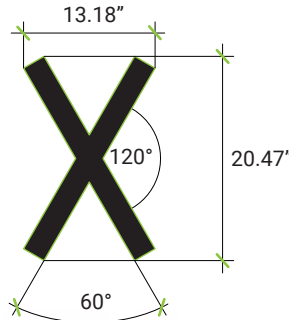

JX-1
X-Shaped Joiner

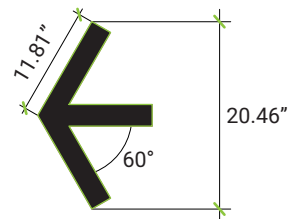

JA-1
Arrow-Shaped Joiner

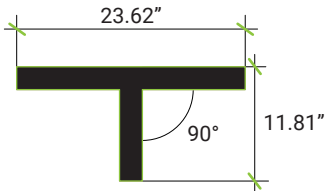

JT-1
T-Shaped Joiner

Joiners used with ring shapes are specifically designed to accommodate various dimensions up to the diameter of the ring. These joiners ensure a secure and seamless connection between straight runs and ring segments, maintaining both functionality and aesthetics.

Please Consult Factory.



SR-Straight Runs:

2 ft, 4 ft, 6 ft, 8 ft, Custom

Custom straight runs are available in increments of 1 inch.

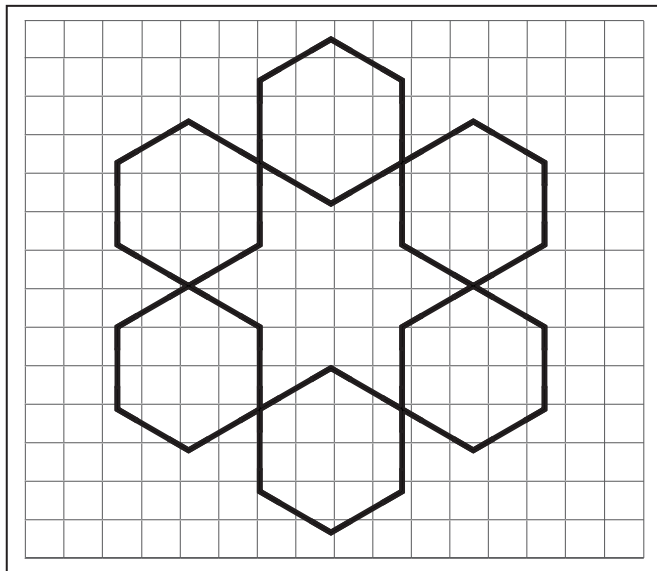
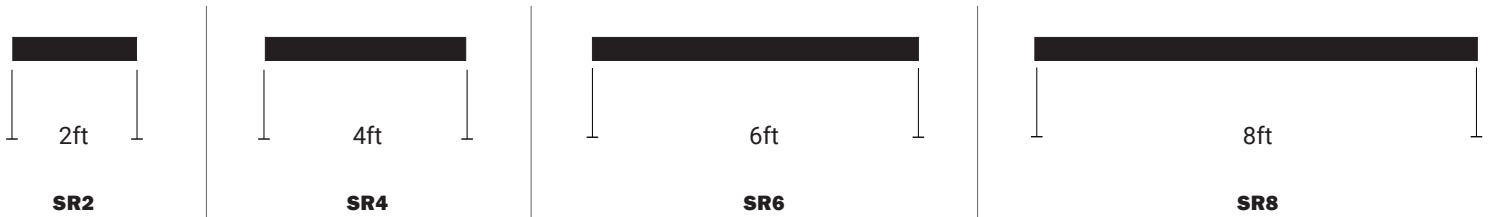

How to **design**
your OWN shapes!

1. Select the pieces you want to use to build the fixture. Refer to pages 3, 4, and 5 to choose the desired pieces.
2. Draw the fixture on the grid located on the last page and send it to yuchen@iuseelite.com
3. Once you approve the design, we will bring it to life.

ORDERING TABLE

Specify the length of the 'SR' Straight run on one side of the fixture, as it is a symmetrical shape and knowing the size of one side will provide the overall dimensions.

Example: SR:

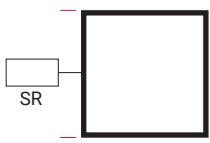

GSS-Single Square

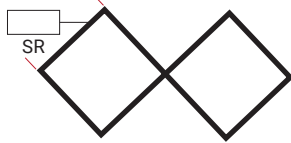

GTS-Two Squares

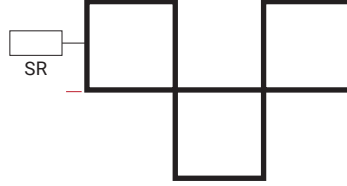

GTHS-Three Squares

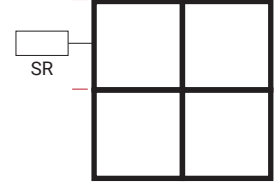

GFS-Four Squares

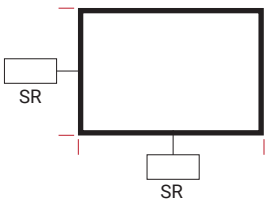

GSR-Single Rectangle

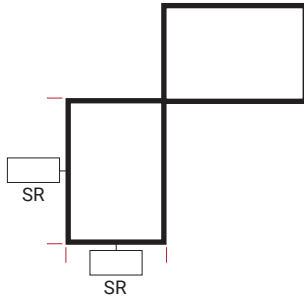

GTR-Two Rectangles

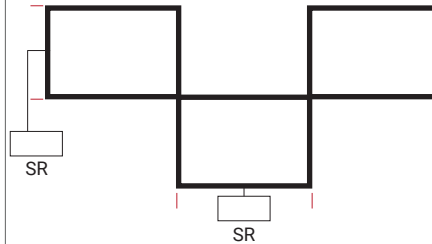

GTHR-Three Rectangles

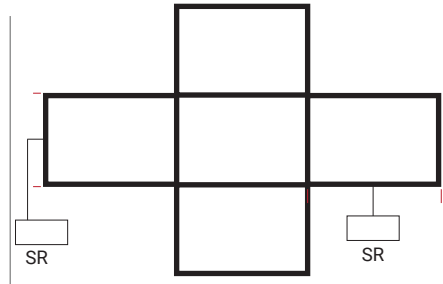

GFR-Five Rectangles

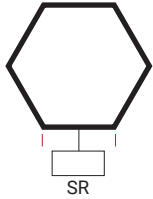

GSH-Single Hexagon

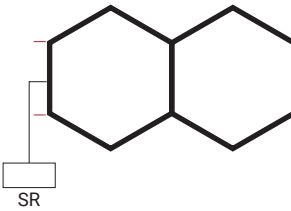

GTH-Two Hexagons

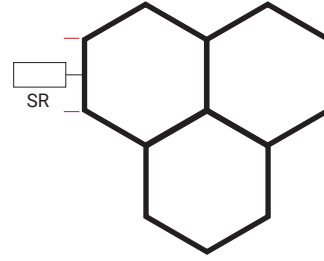

GTHR-Three Hexagons

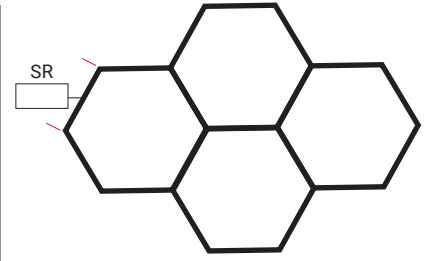

GFH-Four Hexagons

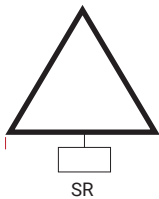

GST-Single Triangle

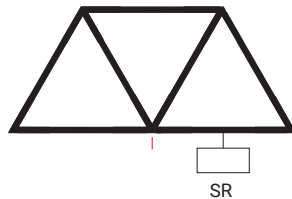

GTT-Three Triangles

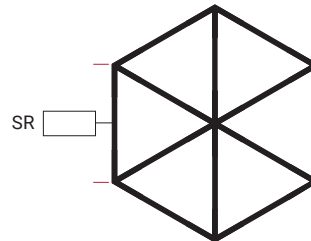

GSTR-Six Triangles

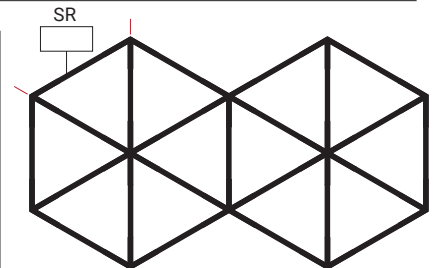

GTWT-Twelve Triangles

V SHAPED JOINERS:

The V-shaped joiners are crucial for achieving the correct angled finish of the luminaire. Available in 60°, 90°, and 120° options, these joiners allow you to create precise angles and adjust the width of the luminaire to suit your design needs. Depending on the joiner used, the luminaire can have a wider or narrower appearance, offering flexibility in creating the perfect lighting effect and seamless alignment at the desired angle.

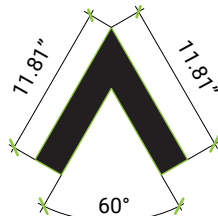

V60J-V Shaped Joiner 60°

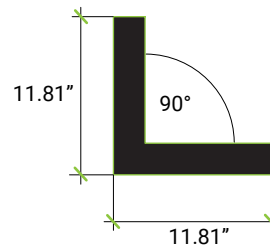

V90J-V Shaped Joiner 90°

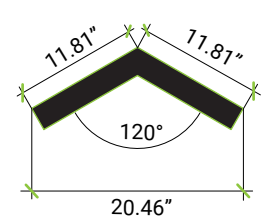

V120J-V Shaped Joiner 120°

ORDERING TABLE

Example: SOUL-G-TWH-WM-2-GSS-V60J-D650L-1C-REM-DIM10-MVOLT-6500K-2700K-95-WH

SERIES	WIDTH	¹ SHAPE	V JOINER	LUMENS / DIRECT
SOUL-G-TWH-WM	2 - 2.3"x2.3"	GSS - Single Square GTS - Two Squares GTHS - Three Squares GFS - Four Squares GSR - Single Rectangle GTR - Two Rectangles GTHR - Three Rectangles GFR - Five Rectangles GSH - Single Hexagon GTH - Two Hexagons GTHR - Three Hexagons GFH - Four Hexagons GST - Single Triangle GTT - Three Triangles GSTR - Six Triangles GTWT - Twelve Triangles ² CUS - Custom	V60J - V Shaped Joiner 60° V90J - V Shaped Joiner 90° V120J - V Shaped Joiner 120°	D650L - 650 Lumens Per Ft D900L - 900 Lumens Per Ft

DISTRIBUTION	NUMBER OF CIRCUITS	DRIVER MOUNT	DIMMING	VOLTAGE
(blank) - Standard	1C 2C	REM - Remote Driver	DIM10 - 0-10V Dimming ELDO10.1 - ELDO 0-10V ELDODMX.1 - EldoLED DMX ELDODALI.1 - ELDODALI.1 BLE - Wireless Bluetooth Control	MVOLT - 120-277V

CCT	CRI	FINISH	³ EMERGENCY	TOTAL RUN / FT & IN
6500K - 2700K	90 - 90CRI 95 - 95CRI	WH - White BK - Black SI - Silver RAL - Consult Factory	REM-0-EMG-LED-10W REM-0-EMG-LED-20W	XX.YY.ZZ XX= Length in Feet YY= Fraction in Inches ZZ= Fractions of an Inch e.g. 22 ft. 6 in. 1/2 in

1. Please refer to the previous page to specify the length of the selected shape.
2. Refer to the last page and sketch your design on the grid. Afterward, email it to yuchen@iuseelite.com with any required details.
3. Remote emergency option available, please consult factory.

Be Inspired

Shapes

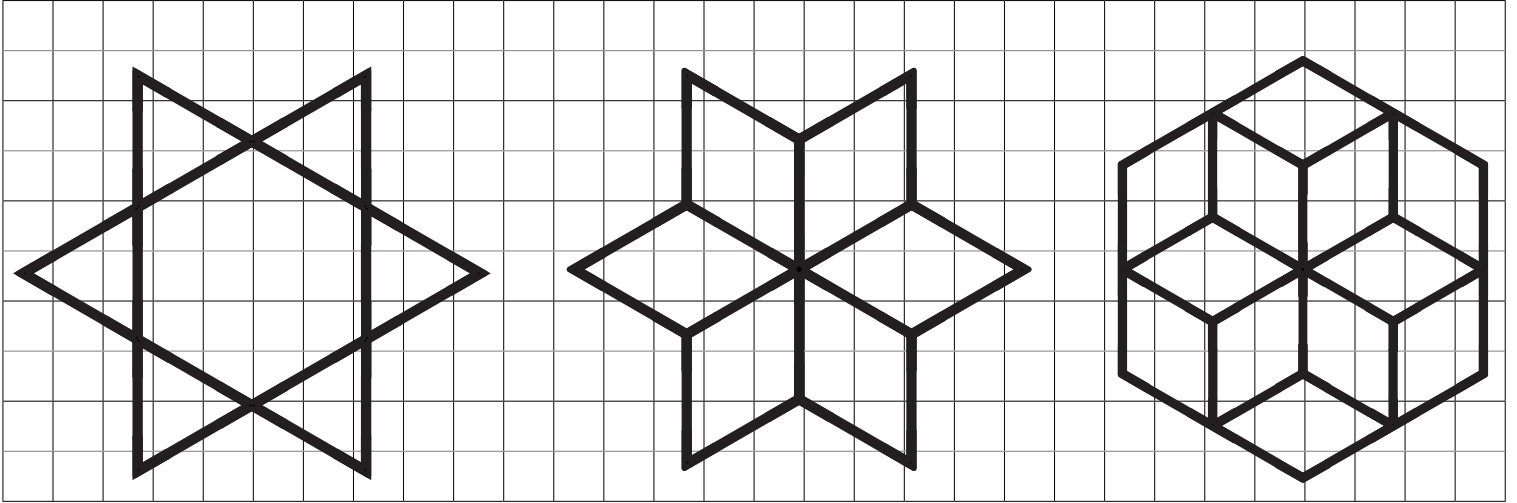



Sketch your design using the grid space below and email it to yuchen@iuseelite.com



Square



Rectangle

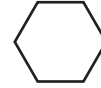

Hexagon



Triangle

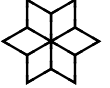

Free Pattern

