



Static White



FLICKER FREE

RoHS

**INTRODUCING**

SOUL Geometric Shapes

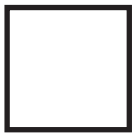

Square



Rectangle



Hexagon



Triangle

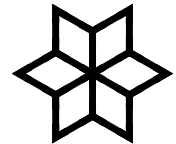

Free Pattern

**SOUL Geometric Shapes** — is a versatile Free-Form Shape LED luminaire inspired by ancient Peruvian Nazca lines. SOUL-GEOMETRIC brings spirit, energy, and action to large space environments, harnessing the flexibility and creativity of a tapelight while maintaining the quality and durability of a solid luminaire. Designed to simultaneously enhance creativity and functionality in a space, this unique fixture comes in separate pieces which join to create geometric shapes like squares, rectangles, hexagons, and triangles that act as building blocks for various flowing, long running, intricate designs.

Available with surface mount, recessed trimles mount, suspended mount, and wall mounting options, in a standard width of 2.3". Capable of max. continuous runs of 8 feet and ideal for creating patterned, dynamic luminaires that add an element of originality to corporate offices, educational, commercial, and retail spaces.

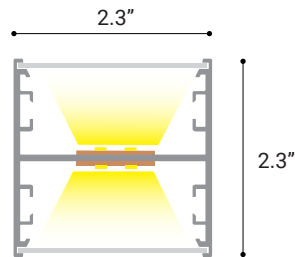

Size

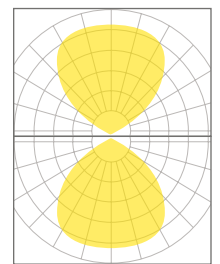

Ligth Distribution

**OPTICS & PERFORMANCE**

This item's high-efficiency LED optical system includes a precision-cut acrylic lens with a smooth frosted finish for glare-free, even illumination and reflective sidewalls that help distribute the LED light evenly across the acrylic-surface. The lens features a snap-in design that fits securely into the groove of the fixture's body, making it easy to remove for access to the LED driver and LED board. This SOUL-LED fixture can be customized into various shapes by assembling different angles and degrees to meet diverse architectural needs.

**CONSTRUCTION**

Body constructed from up to 90% recyclable, extruded architectural-grade 6063 aluminum with a minimum wall thickness of 0.075", to ensure durability and sustainability. Lenses are made from twin-layered, extruded high-impact acrylic, with a maximum single length of 8 ft.

**DISTRIBUTION PATTERNS & DIFFUSER**

Features an optically extruded, high-impact acrylic lens for a uniform, smooth illumination with reduced glare and precise light output control. Lens designed to snap securely into the housing and integrate seamlessly with the fixture, to ensure a refined and clean appearance.

**CRM INSTALLATION**

Lighting design will adhere to the factory shop drawing. For continuous mounting, the first section will always include the power supply feed. Housing connections will feature a joint bracket and a male/female connector for electrical connections. For special mounting requirements, please follow the provided mounting instructions.

**SUPPORT CABLE/FEED**

For the suspended mount version of SOUL Geometric, aircraft cable mounting points are available at intervals of 2, 4, 6, 8, and 11 feet centered along the fixture's length, with the mounting points positioned a 1/2 inch from each end of the fixture or run. Adjustable cable mounts can be made to align with the existing mounting points, as per the installation instructions, and allow for adjustment across the fixture's width for balance.

The minimum suspension height from the ceiling to the top of the fixture is 4 inches, and the fixture can be leveled at the mounting bracket. All sections come pre-wired with push-in connectors for quick setup, and the fixtures can be connected in a straight, continuous run using the supplied alignment brackets, pins, and internal joiners. Refer to the installation instructions for details on different ceiling interface options.

**LED DYNAMIC PLATFORM OPTIONS**

Our advanced LED board is designed for superior output, efficacy, and reliability. Featuring a high Color Rendering Index (CRI) of 95, these LEDs provide exceptional color accuracy and vibrancy. With a remarkable lifespan of L70 at over 100,000 hours (TM-21), you can trust in their long-lasting performance. Enjoy consistent color with variations within 2-Step MacAdam ellipses. Available in a range of correlated color temperatures (CCT) including 3000K, 3500K, 4000K, 5000K, and 6500K these LEDs meet diverse lighting needs.

**DIMMING & DRIVER INFORMATION**

**DIM10** - 0-10V dimming on either MVOLT 120, 277. Dimmable down to 1% of initial lumens, standard.

**DIMTR** - Triac & Electronic low voltage dimming.

**LUTH** - Lutron LDE1 Hi-Lume Eco System with Soft Fade to Black dimming technology.

**ELDO10.1**- E IdoLED SoloDrive 0-10V. Dimming down to 0.1%. Linear dimming curve.

**EldoDALI** - DALI DT6, DT8 dimming down to 1%.

**ELDODMX.1** - EldoLED PowerDrive dimming down to 0.1%.

**BLE** - Luminaires may be controlled, grouped, scheduled or placed in scenes and or zones Via Cassambi Bluetooth 4.0 App.

**FINISH**

Standard color - White / Black / Anodized aluminum.

RAL CLASSIC COLORS.

**WARRANTY**

Five-year warranty for parts and components.(Labor not included).

**LISTINGS**

cETLus - Listed

RoHs - Contains no mercury or lead and RoHS compliant

**TECHNICAL DETAILS**



<b>INPUT VOLTAGE</b>	120-277V
<b>POWER</b>	Downlight 6W/ft, 9W/ft - Uplight 3W/ft, 4.5W/ft
<b>EFFICIENCY LM/W</b>	100Lm/W
<b>LUMENS PER FOOT</b>	Downlight 650L, 900L - Uplight 300L, 450L
<b>CRI</b>	90+, 95+
<b>LIGHT DISTRIBUTION</b>	Direct - Indirect
<b>CCT</b>	30K, 35K, 40K, 50K, 65K,
<b>SHAPES</b>	Square, Rectangle, Hexagon, Triangle, Free-form Pattern

<b>MOUNTING</b>	Suspended Mount
<b>SIZE</b>	W2.3" x H2.3"
<b>CURVE DEGREES</b>	30°, 45°, 60°, 90°, 120° Custom Degrees Available
<b>CURVE RADIUS</b>	24", 36", 48", 60", 72", 84" Custom Radius Available
<b>CONTINUOUS LENGTHS</b>	2 ft, 4 ft, 6 ft, 8 ft Custom Lengths Available
<b>COLOR</b>	White, Black, Silver, Custom RAL
<b>DIMMING &amp; CONTROLS</b>	0-10V Flicker Free 1% Dimming (DIM10), LUTH, ELDO10.1-, ELDODMX.1, ELDODALI.1, DIMTR, BLE.
<b>EMERGENCY</b>	Remote Emergency Option. Consult Factory

**Linear Joiners**

Linear joiners are essential for connecting straight segments and creating seamless transitions between different sections. These joiners ensure the formation of precise, straight edges and a clean, sharp finish.

Samples

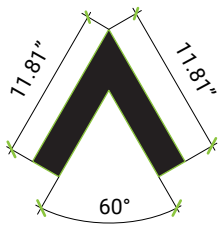
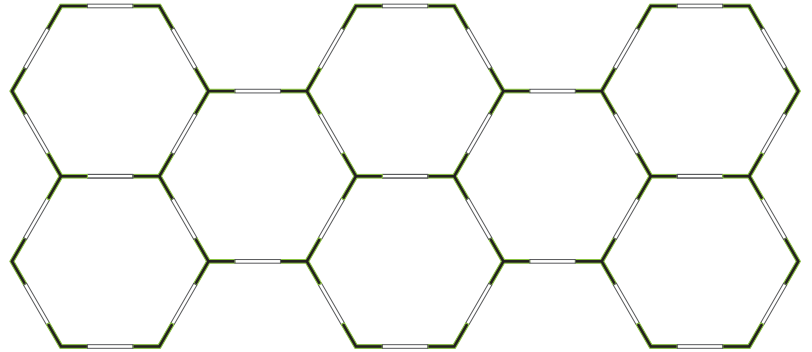
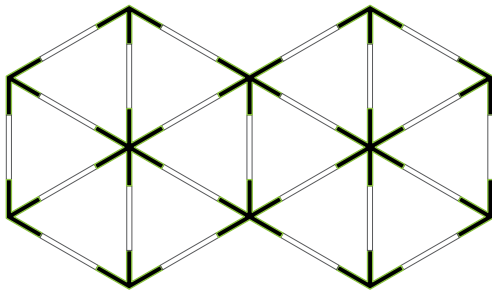

**V60J**  
V60°-Shaped Joiner

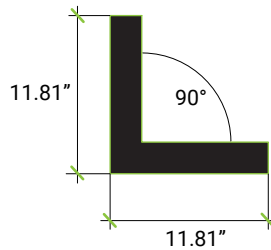

**V90J**  
V90°-Shaped Joiner

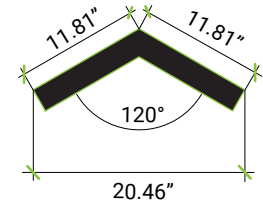

**V120J**  
V120°-Shaped Joiner

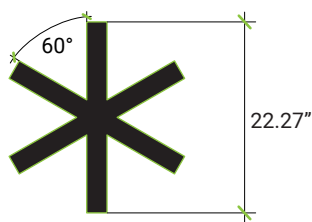

**JK-1**  
Asterisk-Shaped Joiner

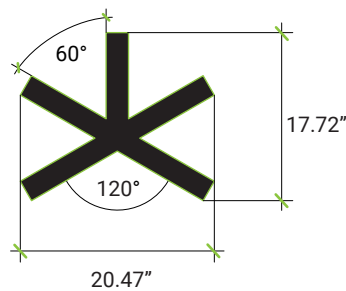

**JK-2**  
Asterisk-Shaped Joiner

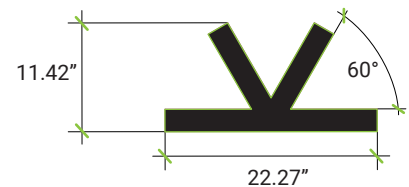

**JK-3**  
Half Asterisk-Shaped Joiner

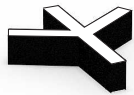
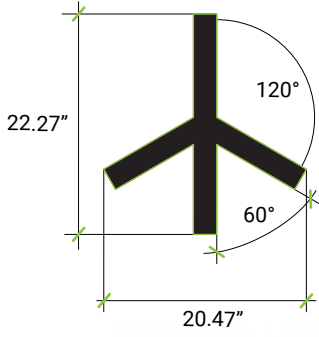

**JDY-1**  
Double Y-Shaped Joiner

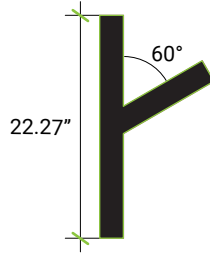

**JLY-1**  
Lowercase y-Shaped Joiner

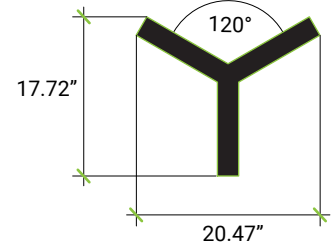

**JY-1**  
Y-Shaped Joiner

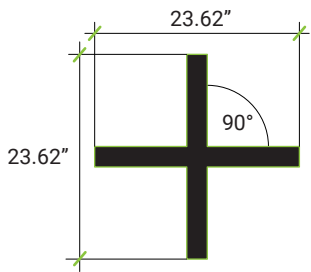

**J+-1**  
+-Shaped Joiner

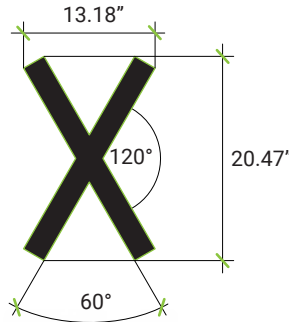

**JX-1**  
X-Shaped Joiner

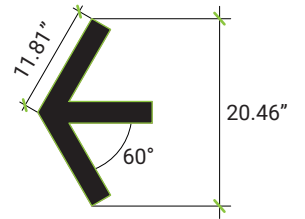

**JA-1**  
Arrow-Shaped Joiner

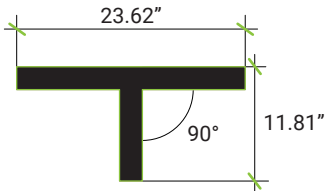

**JT-1**  
T-Shaped Joiner

Joiners used with ring shapes are specifically designed to accommodate various dimensions up to the diameter of the ring. These joiners ensure a secure and seamless connection between straight runs and ring segments, maintaining both functionality and aesthetics.

**Please Consult Factory.**



**SR-Straight Runs:**

2 ft, 4 ft, 6 ft, 8 ft, Custom

Custom straight runs are available in increments of 1 inch.

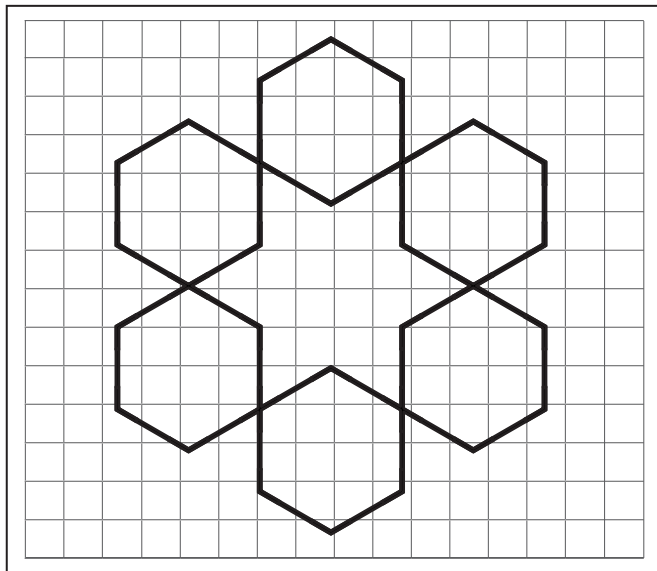
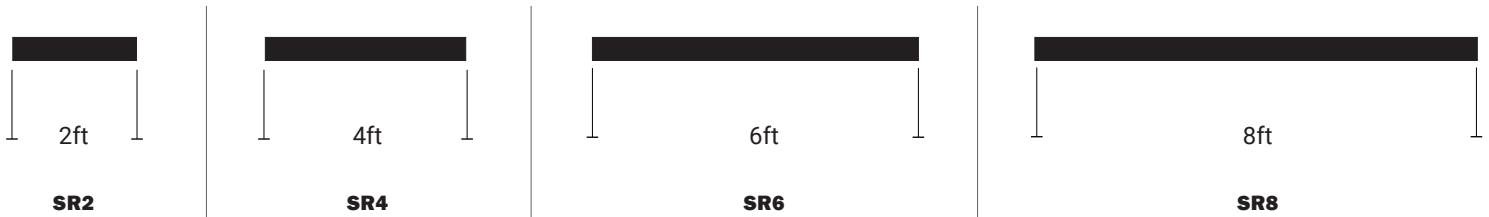

How to **design**  
**your** OWN shapes!

1. Select the pieces you want to use to build the fixture. Refer to pages 3, 4, and 5 to choose the desired pieces.
2. Draw the fixture on the grid located on the last page and send it to [yuchen@iuseelite.com](mailto:yuchen@iuseelite.com)
3. Once you approve the design, we will bring it to life.

### ORDERING TABLE

Specify the length of the 'SR' Straight run on one side of the fixture, as it is a symmetrical shape and knowing the size of one side will provide the overall dimensions.

Example: SR:

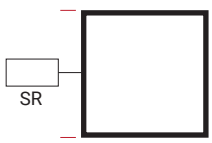

**GSS**-Single Square

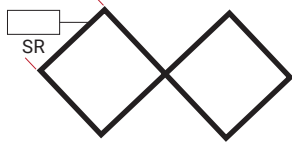

**GTS**-Two Squares

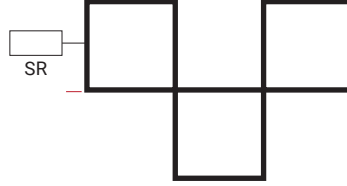

**GTHS**-Three Squares

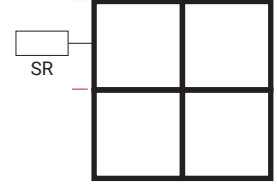

**GFS**-Four Squares

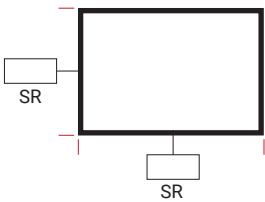

**GSR**-Single Rectangle

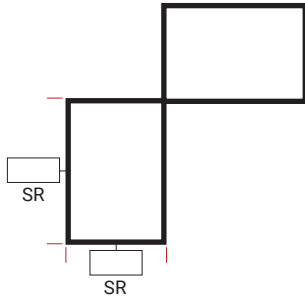

**GTR**-Two Rectangles

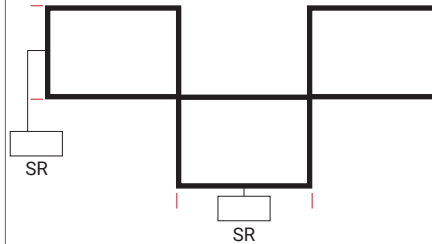

**GTHR**-Three Rectangles

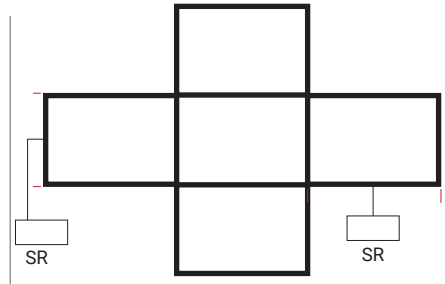

**GFR**-Five Rectangles

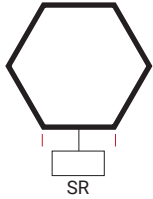

**GSH**-Single Hexagon

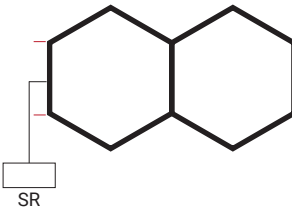

**GTH**-Two Hexagons

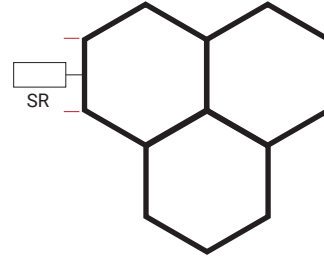

**GTHR**-Three Hexagons

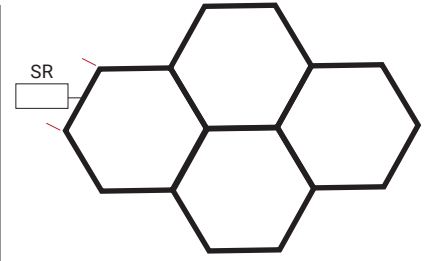

**GFH**-Four Hexagons

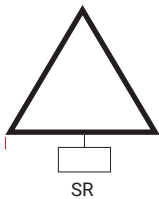

**GST**-Single Triangle

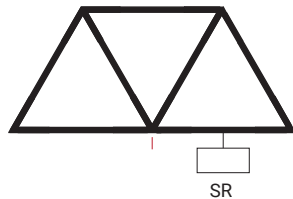

**GTT**-Three Triangles

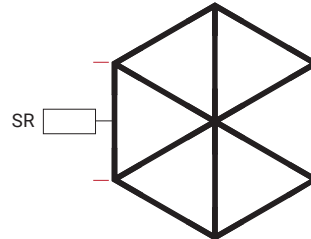

**GSTR**-Six Triangles

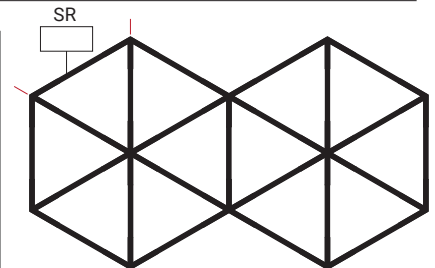

**GTWT**-Twelve Triangles

### V SHAPED JOINERS:

The V-shaped joiners are crucial for achieving the correct angled finish of the luminaire. Available in 60°, 90°, and 120° options, these joiners allow you to create precise angles and adjust the width of the luminaire to suit your design needs. Depending on the joiner used, the luminaire can have a wider or narrower appearance, offering flexibility in creating the perfect lighting effect and seamless alignment at the desired angle.

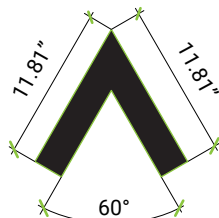

**V60J**-V Shaped Joiner 60°

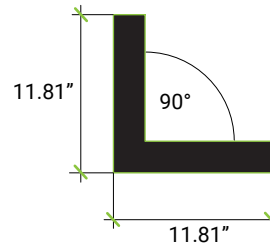

**V90J**-V Shaped Joiner 90°

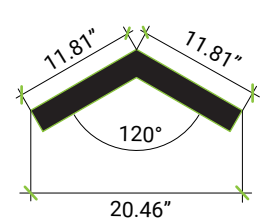

**V120J**-V Shaped Joiner 120°

**ORDERING TABLE**

Example: SOUL-G-DI-SM-2-GSS-V60J-D650L-U300L-1C-DIM10-MVOLT-35K-95-WH

SERIES	WIDTH	<sup>1</sup> SHAPE	V JOINER	LUMENS / DIRECT
SOUL-G-DI-SM	2 - 2.3"x2.3"	<b>GSS</b> - Single Square <b>GTS</b> - Two Squares <b>GTHS</b> - Three Squares <b>GFS</b> - Four Squares <b>GSR</b> - Single Rectangle <b>GTR</b> - Two Rectangles <b>GTHR</b> - Three Rectangles <b>GFR</b> - Five Rectangles <b>GSH</b> - Single Hexagon <b>GTH</b> - Two Hexagons <b>GTHR</b> - Three Hexagons <b>GFH</b> - Four Hexagons <b>GST</b> - Single Triangle <b>GTT</b> - Three Triangles <b>GSTR</b> - Six Triangles <b>GTWT</b> - Twelve Triangles <sup>2</sup> <b>CUS</b> - Custom	<b>V60J</b> - V Shaped Joiner 60° <b>V90J</b> - V Shaped Joiner 90° <b>V120J</b> - V Shaped Joiner 120°	<b>D650L</b> - 650 Lumens Per Ft <b>D900L</b> - 900 Lumens Per Ft

DISTRIBUTION	LUMENS / INDIRECT	DISTRIBUTION	NUMBER OF CIRCUITS	DRIVER MOUNT
(blank) - Standard	<b>U300L</b> - 300 Lumens Per Ft <b>U450L</b> - 450 Lumens Per Ft	(blank) - Standard	<b>1C</b> (Up and down lights controlled together) <b>2C</b> (Up and down lights controlled individually)	<b>(blank)</b> - Inside Fixture <b>REM</b> - Remote Driver

DIMMING	VOLTAGE	CCT	CRI	FINISH	<sup>4</sup> EMERGENCY
<b>DIM10</b> - 0-10V Dimming <b>LUTH</b> - Lutron HiLum <b>ELDO10.1</b> - ELDO 0-10V <b>ELDODMX.1</b> - EldoLED DMX <b>ELDODALI.1</b> - ELDODALI.1 <sup>3</sup> <b>DIMTR</b> - Triac & ELV <b>BLE</b> - Wireless Bluetooth Control	<b>MVOLT</b> - 120-277V	<b>30K</b> - 3000K <b>35K</b> - 3500K <b>40K</b> - 4000K <b>50K</b> - 5000K <b>65K</b> - 6500K	<b>90</b> - 90CRI <b>95</b> - 95CRI	<b>WH</b> - White <b>BK</b> - Black <b>SI</b> - Silver <b>RAL</b> - Consult Factory	<b>REM-0-EMG-LED-10W</b> <b>REM-0-EMG-LED-20W</b>

**TOTAL RUN / FT & IN**  
XX.YY.ZZ

XX= Length in Feet  
 YY= Fraction in Inches  
 ZZ= Fractions of an Inch  
 e.g. 22 ft. 6 in. 1/2 in

1. Please refer to the previous page to specify the length of the selected shape.
2. Refer to the last page and sketch your design on the grid. Afterward, email it to [yuchen@iuseelite.com](mailto:yuchen@iuseelite.com) with any required details.
3. DIMTR available in 120V only.
4. Remote emergency option available, please consult factory.

**Be Inspired**

Shapes

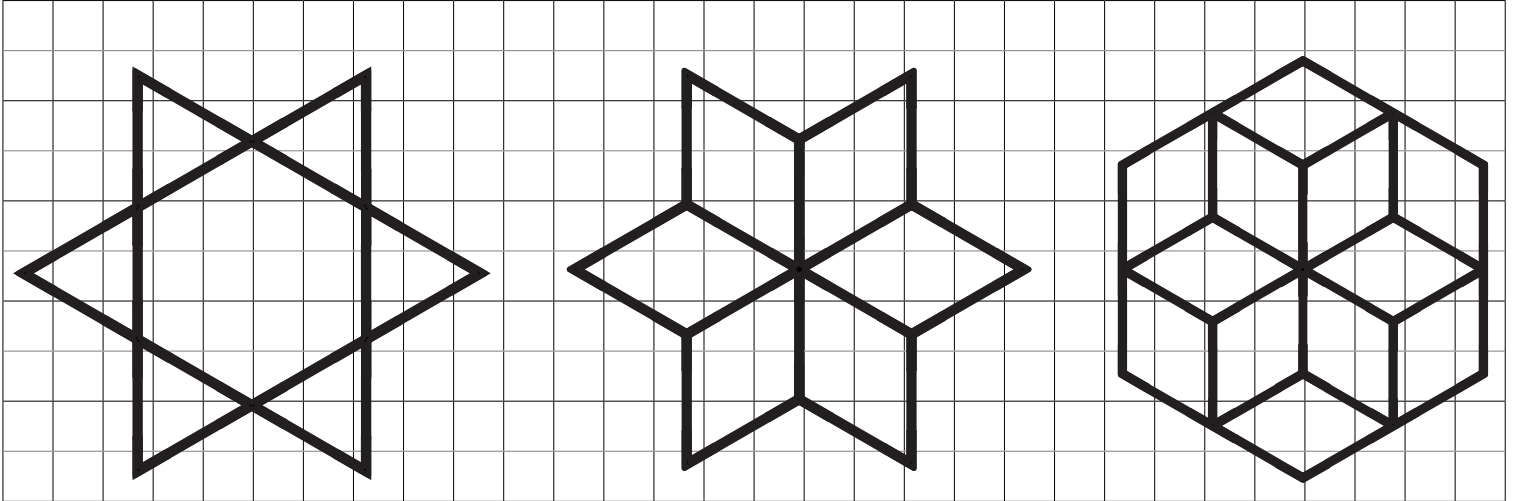



Sketch your design using the grid space below and email it to [yuchen@iuseelite.com](mailto:yuchen@iuseelite.com)



Square



Rectangle



Hexagon



Triangle

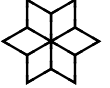

Free Pattern

