

SC8INC

8" ARCHITECTURAL INCANDESCENT CYLINDER DOWNLIGHT

NEW

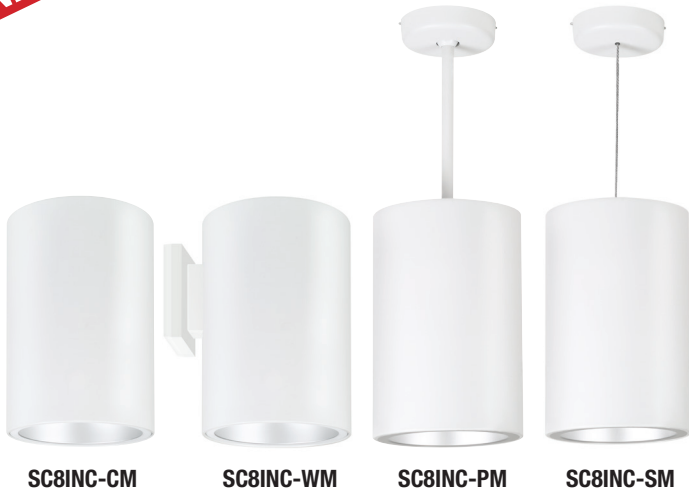

SC8INC-CM

SC8INC-WM

SC8INC-PM

SC8INC-SM

TRIM: **8101 REFLECTOR**

MAX. LAMP WATTAGE: **150W-A21 / 150W PAR38 / 13W LED PAR30**

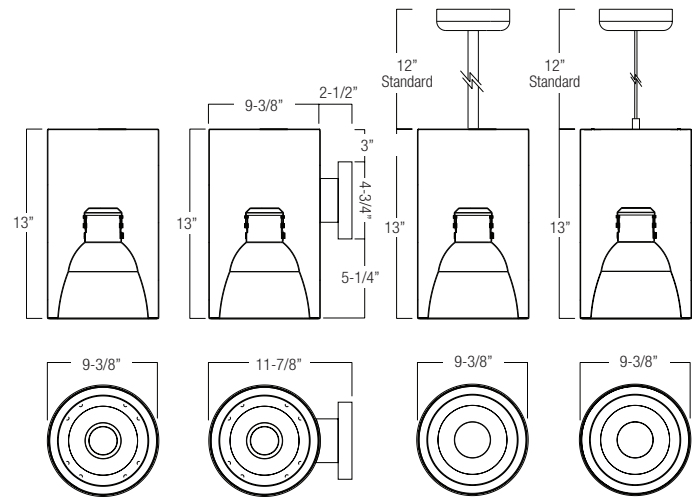

DESCRIPTION

LAMP HOLDER - Die-cast aluminum lamp holder effectively provides heat dissipation and ventilation. Unitized optics guarantees proper trim to housing installation. Tool-less installation adjustability from either outside the housing or inside the housing.

MOUNTING BRACKET - Ceiling mount bracket provided for direct installation with 3-1/4" to 4" octagonal and square junction box. Pendant mount option is available and supplied with 10-1/2" stem and 5" diameter canopy cover. Ideal for slope applications up to 45 degrees.

RETAINING SPRINGS - Precision tooled springs secure trim to mounting frame, for effortless and tool-less installation.

BALLAST - Ballast is accessible from below, no tools required. Ballast supplied is manufactured by Advance.

MOUNTING FRAME - Die formed steel housing with adjustable bracket allows optical adjustment of lamp. Unitized optics guarantees proper trim to housing tool-less installation.

OPTICS

REFLECTOR - Self-flanged .050" aluminum reflector with low iridescent finish. Reflector provides 45-degree lamp-to-reflector image cutoff.

GROOVE BAFFLE - Self-flanged one-piece aluminum with concentric rings.

LENS - Choice of either tempered clear, tempered prismatic or tempered frosted lens fastened with two torsion springs for easy re-lamping.

LISTING

UL listed for through-branch circuit wiring



Please visit our website for the most updated information on each product.



Lumen values rated at 3000K color temperature.

SC8INC - ITEM SELECTOR: (Please check the boxes below for the option desired)

MOUNTING	LAMP LUMEN	BODY COLOR	VOLTAGE	TRIM TYPE & DESCRIPTION	REFLECTOR	BAFFLE
<input type="checkbox"/> CM - Ceiling Mount	<input type="checkbox"/> PAR30-500L	<input type="checkbox"/> WH - White	<input type="checkbox"/> 120	<input type="checkbox"/> 8101 Reflector	<input type="checkbox"/> 8112 Baf./Frost Gls. Lns.	<input type="checkbox"/> CL-WH
<input type="checkbox"/> WM - Wall Mount	<input type="checkbox"/> PAR30-800L	<input type="checkbox"/> BK - Black	<input type="checkbox"/> 277	<input type="checkbox"/> 8102 Baffle/Reflector	<input type="checkbox"/> 8113 Baf./Tem. Clr. Gls.	<input type="checkbox"/> CL-SCH
<input type="checkbox"/> PM12 - 12" Pendant Mount	<input type="checkbox"/> PAR38-600L	<input type="checkbox"/> BZ - Bronze		<input type="checkbox"/> 8103 Ref./Fres. Gls. Lns.	<input type="checkbox"/> 8114 Ref./Frost Gls. Lns.	<input type="checkbox"/> SHZ-SHZ
<input type="checkbox"/> PM18 - 18" Pendant Mount	<input type="checkbox"/> PAR38-800L	<input type="checkbox"/> SI - Silver		<input type="checkbox"/> 8104 Ref./Pris. Gls. Lns.	<input type="checkbox"/> 8115 Ref./Tem. Clr. Gls.	<input type="checkbox"/> SHZ-WH
<input type="checkbox"/> PM24 - 24" Pendant Mount	<input type="checkbox"/> PAR38-1000L			<input type="checkbox"/> 8105 Baf./Fres. Gls. Lns.		<input type="checkbox"/> WT-WH
<input type="checkbox"/> PM36 - 36" Pendant Mount	<input type="checkbox"/> PAR38-1300L			<input type="checkbox"/> 8106 Baf./Pris. Gls. Lns.		<input type="checkbox"/> W-WH
<input type="checkbox"/> PM48 - 48" Pendant Mount	<input type="checkbox"/> NO LAMP			<input type="checkbox"/> 8107 Wall Wash Ref.		<input type="checkbox"/> MB-WH
<input type="checkbox"/> SM - Suspended Mount *For other sizes consult factory.				<input type="checkbox"/> 8108 Crossblade Ref.		

Custom color available, please consult factory. Must provide RAL#

The cylinder's bodies are available in WH - White, BK - Black, BZ - Bronze and SI - Silver.

Specifications:

SC8INC

MOUNTING: _____ BODY COLOR: _____ VOLTAGE: _____ TRIM TYPE: _____ REFLECTOR: _____ BAFFLE: _____

Sample of Catalog Number: **SC8INC-CM-WH-120-8101-CL-WH**

REFLECTOR	BAFFLE	RING
CL Clear	WH White	WH Self-Flange White
SHZ Satin Haze (Low Iridescent)	P Black	SCH Self-Flange Chrome
WT Wheat		SHZ Satin Haze
MB Black		
W White		

*For custom baffle, reflector, trim ring, glass color and lens options, please consult factory.

8101 -
Reflector



TRIM FINISH:
 • CL-WH • WT-WH
 • CL-SCH • W-WH
 • SHZ-SHZ • MB-WH
 • SHZ-WH



A= 7-1/2"
B= 9-1/8"

8102 -
Baffle with Reflector



TRIM FINISH:
 • W-CL-WH
 • P-CL-WH



A= 7-1/2"
B= 9-1/8"
C= 1-3/4"

8107 -
Wall Wash Reflector



TRIM FINISH:
 • CL-WH • WT-WH
 • CL-SCH • W-WH
 • SHZ-SHZ • MB-WH
 • SHZ-WH



A= 7-1/2"
B= 9-1/8"

8108 -
Crossblade Reflector



TRIM FINISH:
 • CL-WH • WT-WH
 • CL-SCH • W-WH
 • SHZ-SHZ • MB-WH
 • SHZ-WH

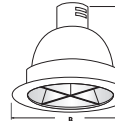

A= 7-13/16"
B= 9-1/8"

8103 -
Reflector with Fresnel Glass Lens



TRIM FINISH:
 • CL-WH • WT-WH
 • CL-SCH • W-WH
 • SHZ-SHZ • MB-WH
 • SHZ-WH



A= 7-13/16"
B= 9-1/8"
C= 1-3/4"

8104 -
Reflector with Prismatic Glass Lens



TRIM FINISH:
 • CL-WH • WT-WH
 • CL-SCH • W-WH
 • SHZ-SHZ • MB-WH
 • SHZ-WH



A= 7-13/16"
B= 9-1/8"
C= 1-3/4"

8114 -
Reflector with Frosted Glass Lens



TRIM FINISH:
 • CL-WH • WT-WH
 • CL-SCH • W-WH
 • SHZ-SHZ • MB-WH
 • SHZ-WH



A= 7-13/16"
B= 9-1/8"
C= 1-3/4"

8115 -
Reflector with Tempered Clear Glass



TRIM FINISH:
 • CL-WH • WT-WH
 • CL-SCH • W-WH
 • SHZ-SHZ • MB-WH
 • SHZ-WH

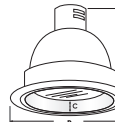

A= 7-13/16"
B= 9-1/8"
C= 1-3/4"

8105 -
Baffle with Fresnel Glass Lens



TRIM FINISH:
 • W-WH
 • P-WH



A= 7-13/16"
B= 9-1/8"
C= 1-3/4"

8106 -
Baffle with Prismatic Glass Lens



TRIM FINISH:
 • W-WH
 • P-WH



A= 7-13/16"
B= 9-1/8"
C= 1-3/4"

8112 -
Baffle with Frosted Glass Lens



TRIM FINISH:
 • W-WH
 • P-WH



A= 7-13/16"
B= 9-1/8"
C= 1-3/4"

8113 -
Baffle with Tempered Clear Glass



TRIM FINISH:
 • W-WH
 • P-WH



A= 7-13/16"
B= 9-1/8"
C= 1-3/4"

PHOTOMETRIC DATA — 8" INCANDESCENT CYLINDER HOUSING

SC8INC-8101CL

TEST NO.: LLI 0205-10A

LAMP: SYLVANIA 150A21

LUMENS: 2780

TOTAL LUMINAIRE EFFICIENCY: 79.6%

SPACING CRITERIA: 1.78

Candle Power Distribution (Candelas)

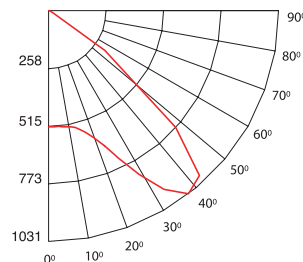

Beam Angle: 112 Degrees

Distance to Plane	Initial Nadir Footcandles	Beam Spread
4'	32.4	11.9'
6'	14.4	17.8'
8'	8.1	23.7'
10'	5.2	29.7'
12'	3.6	35.6'

BEAM DIA. MEASURED AT 10% OF NADIR F.C.

Zonal Lumens Summary

Zone	Lumens	%Lamp	%Fixt
0-30°	501	18	22.6
0-40°	984.91	35.4	44.5
0-60°	2032.95	73.1	91.9
0-90°	2212.72	79.6	100
90-120°	0	0	0
90-130°	0	0	0
90-150°	0	0	0
90-180°	0	0	0
0-180°	2212.72	79.6	100

Total Luminaire Efficiency = 79.6%

Luminance Data (cd/sq.m)

Angle In Degrees	Average
0-90°	38225
45°	16481
65°	1573
75°	918
85°	1302

Zonal Lumen Summary

Zone	Lumens
0-10	40.28
10-20	156.76
20-30	303.97
30-40	483.9
40-50	701.16
50-60	346.88
60-70	157.32
70-80	15.22
80-90	7.23

Candela Tabulation

Zone	Lumens	Candela
0	0	0
1	519.29	519.29
3	518.29	518.29
5	518.37	518.37
7	521.76	521.76
9	524.11	524.11
11	527.3	527.3
13	535.17	535.17
15	548.47	548.47
17	567.02	567.02
19.5	599.01	599.01
22.5	652.59	652.59
25.5	730.1	730.1
29	837.16	837.16
33	950.4	950.4
37.5	1030.52	1030.52
42.5	999.88	999.88
47.5	772.44	772.44
55	309.93	309.93
65	21.79	21.79
75	7.79	7.79
85	3.72	3.72
90	0	0

Coefficients of Utilization - Zonal Cavity Method

Effective Floor Cavity Reflectance 20% = PF

RC	80%				70%				50%				30%				10%				0%			
	70%	50%	30%	10%	70%	50%	30%	10%	50%	30%	10%	50%	30%	10%	50%	30%	10%	50%	30%	10%	0%			
0	95	95	95	95	93	93	93	93	88	88	88	85	85	85	81	81	81	80						
1	88	85	82	79	86	83	80	78	80	78	76	77	75	73	74	72	71	70						
2	81	75	70	66	79	74	69	65	71	67	64	68	65	62	66	63	61	59						
3	74	66	60	56	72	65	59	55	63	58	54	61	57	53	59	55	52	51						
4	68	59	52	47	66	58	51	47	56	50	46	54	49	45	52	48	45	43						
5	62	52	45	40	60	51	45	40	50	44	40	48	43	39	47	42	39	37						
6	57	47	40	35	55	46	39	34	44	39	34	43	38	34	42	37	34	32						
7	52	42	35	30	51	41	35	30	40	34	30	39	33	30	38	33	29	28						
8	48	38	31	26	47	37	31	26	36	30	26	35	30	26	34	29	26	24						
9	45	34	28	23	44	34	27	23	33	27	23	32	27	23	31	26	23	21						
10	42	31	25	21	41	31	25	21	30	24	20	29	24	20	29	24	20	19						

RC - Ceiling Cavity Reflectance

RW - Wall Reflectance