

SC6INC

6" ARCHITECTURAL INCANDESCENT CYLINDER DOWNLIGHT

NEW



SC6INC-CM

SC6INC-WM

SC6INC-PM

SC6INC-SM

TRIM: **6101 REFLECTOR**

MAX. LAMP WATTAGE: **150W-A21 / 150W PAR38 / 13W LED PAR30**

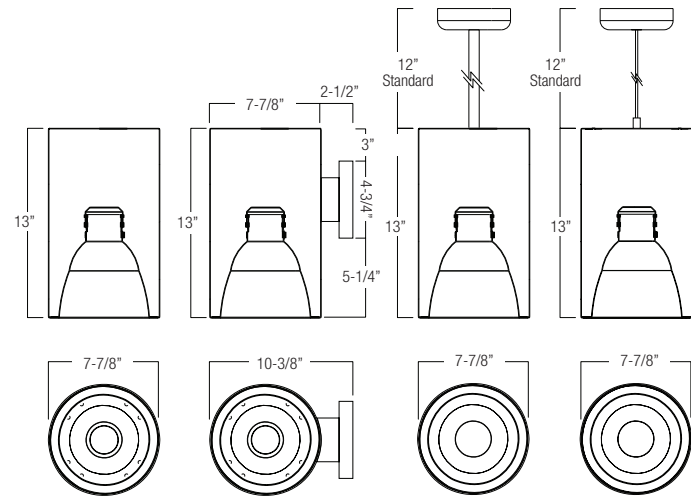

DESCRIPTION

LAMP HOLDER - Die-cast aluminum lamp holder effectively provides heat dissipation and ventilation. Unitized optics guarantees proper trim to housing installation. Tool-less installation adjustability from either outside the housing or inside the housing.

MOUNTING BRACKET - Ceiling mount bracket provided for direct installation with 3-1/4" to 4" octagonal and square junction box. Pendant mount option is available and supplied with 10-1/2" stem and 5" diameter canopy cover. Ideal for slope applications up to 45 degrees.

RETAINING SPRINGS - Precision tooled springs secure trim to mounting frame, for effortless and tool-less installation.

BALLAST - Ballast is accessible from below, no tools required. Ballast supplied is manufactured by Advance.

MOUNTING FRAME - Die formed steel housing with adjustable bracket allows optical adjustment of lamp. Unitized optics guarantees proper trim to housing tool-less installation.

OPTICS

REFLECTOR - Self-flanged .050" aluminum reflector with low iridescent finish. Reflector provides 45-degree lamp-to-reflector image cutoff.

GROOVE BAFFLE - Self-flanged one-piece aluminum with concentric rings.

LENS - Choice of either tempered clear, tempered prismatic or tempered frosted lens fastened with two torsion springs for easy re-lamping.

LISTING

UL listed for through-branch circuit wiring



Please visit our website for the most updated information on each product.



Lumen values rated at 3000K color temperature.

SC6INC - ITEM SELECTOR: (Please check the boxes below for the option desired)

MOUNTING	LAMP LUMEN	BODY COLOR	VOLTAGE	TRIM TYPE & DESCRIPTION	REFLECTOR	BAFFLE
<input type="checkbox"/> CM - Ceiling Mount	<input type="checkbox"/> PAR30-500L	<input type="checkbox"/> WH - White	<input type="checkbox"/> 120	<input type="checkbox"/> 6101 Reflector	<input type="checkbox"/> 6112 Baf./Frost Gls. Lns.	<input type="checkbox"/> CL-WH
<input type="checkbox"/> WM - Wall Mount	<input type="checkbox"/> PAR30-800L	<input type="checkbox"/> BK - Black	<input type="checkbox"/> 277	<input type="checkbox"/> 6102 Baffle/Reflector	<input type="checkbox"/> 6113 Baf./Tem. Clr. Gls.	<input type="checkbox"/> CL-SCH
<input type="checkbox"/> PM12 - 12" Pendant Mount	<input type="checkbox"/> PAR38-600L	<input type="checkbox"/> BZ - Bronze		<input type="checkbox"/> 6103 Ref./Fres. Gls. Lns.	<input type="checkbox"/> 6114 Ref./Frost Gls. Lns.	<input type="checkbox"/> SHZ-SHZ
<input type="checkbox"/> PM18 - 18" Pendant Mount	<input type="checkbox"/> PAR38-800L	<input type="checkbox"/> SI - Silver		<input type="checkbox"/> 6104 Ref./Pris. Gls. Lns.	<input type="checkbox"/> 6115 Ref./Tem. Clr. Gls.	<input type="checkbox"/> SHZ-WH
<input type="checkbox"/> PM24 - 24" Pendant Mount	<input type="checkbox"/> PAR38-1000L			<input type="checkbox"/> 6105 Baf./Fres. Gls. Lns.		<input type="checkbox"/> WT-WH
<input type="checkbox"/> PM36 - 36" Pendant Mount	<input type="checkbox"/> PAR38-1300L			<input type="checkbox"/> 6106 Baf./Pris. Gls. Lns.		<input type="checkbox"/> W-WH
<input type="checkbox"/> PM48 - 48" Pendant Mount	<input type="checkbox"/> NO LAMP			<input type="checkbox"/> 6107 Wall Wash Ref.		<input type="checkbox"/> MB-WH
<input type="checkbox"/> SM - Suspended Mount <small>*For other sizes consult factory.</small>				<input type="checkbox"/> 6108 Crossblade Ref.		

Custom color available, please consult factory. Must provide RAL#

The cylinder's bodies are available in WH - White, BK - Black, BZ - Bronze and SI - Silver.

Specifications:

SC6INC

MOUNTING: _____ BODY COLOR: _____ VOLTAGE: _____ TRIM TYPE: _____ REFLECTOR: _____ BAFFLE: _____

Sample of Catalog Number: **SC8INC-CM-WH-120-6101-CL-WH**

REFLECTOR	BAFFLE	RING
CL Clear	WH White	WH Self-Flange White
SHZ Satin Haze (Low Iridescent)	P Black	SCH Self-Flange Chrome
WT Wheat		SHZ Satin Haze
MB Black		
W White		

*For custom baffle, reflector, trim ring, glass color and lens options, please consult factory.



6"

ARCHITECTURAL INCANDESCENT CYLINDER DOWNLIGHT

6" INCANDESCENT CYLINDER OPTICS

6101 -

Reflector



TRIM FINISH:

- CL-WH
- CL-SCH
- SHZ-SHZ
- SHZ-WH
- WT-WH
- W-WH
- MB-WH

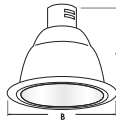

A = 7-1/8"
B = 7-3/8"

6102 -

Baffle with Reflector



TRIM FINISH:

- W-CL-WH
- P-CL-WH

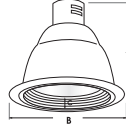

A = 7-1/8"
B = 7-3/8"
C = 1"

6107 -

Wall Wash Reflector



TRIM FINISH:

- CL-WH
- CL-SCH
- SHZ-SHZ
- SHZ-WH
- WT-WH
- W-WH
- MB-WH

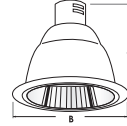

A = 7-1/8"
B = 7-3/8"

6108 -

Crossblade Reflector



TRIM FINISH:

- CL-WH
- CL-SCH
- SHZ-SHZ
- SHZ-WH
- WT-WH
- W-WH
- MB-WH

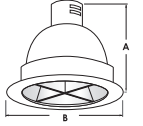

A = 7-1/2"
B = 7-3/8"

6103 -

Reflector with Fresnel Glass Lens



TRIM FINISH:

- CL-WH
- CL-SCH
- SHZ-SHZ
- SHZ-WH
- WT-WH
- W-WH
- MB-WH

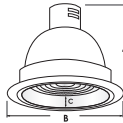

A = 7-1/2"
B = 7-3/8"
C = 1"

6104 -

Reflector with Prismatic Glass Lens



TRIM FINISH:

- CL-WH
- CL-SCH
- SHZ-SHZ
- SHZ-WH
- WT-WH
- W-WH
- MB-WH

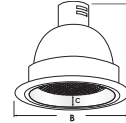

A = 7-1/2"
B = 7-3/8"
C = 1"

6114 -

Reflector with Frosted Glass Lens



TRIM FINISH:

- CL-WH
- CL-SCH
- SHZ-SHZ
- SHZ-WH
- WT-WH
- W-WH
- MB-WH

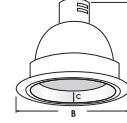

A = 7-1/2"
B = 7-3/8"
C = 1"

6115 -

Reflector with Tempered Clear Glass



TRIM FINISH:

- CL-WH
- CL-SCH
- SHZ-SHZ
- SHZ-WH
- WT-WH
- W-WH
- MB-WH

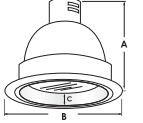

A = 7-1/2"
B = 7-3/8"
C = 1"

6105 -

Baffle with Fresnel Glass Lens

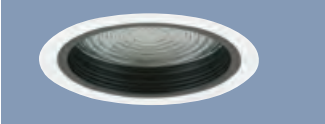

TRIM FINISH:

- W-WH
- P-WH

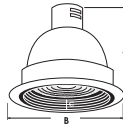

A = 7-1/2"
B = 7-3/8"
C = 1"

6106 -

Baffle with Prismatic Glass Lens

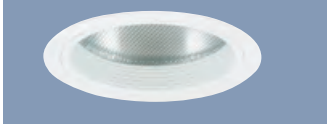

TRIM FINISH:

- W-WH
- P-WH

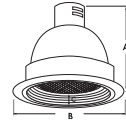

A = 7-1/2"
B = 7-3/8"
C = 1"

6112 -

Baffle with Frosted Glass Lens



TRIM FINISH:

- W-WH
- P-WH

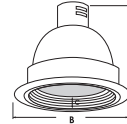

A = 7-1/2"
B = 7-3/8"
C = 1"

6113 -

Baffle with Tempered Clear Glass



TRIM FINISH:

- W-WH
- P-WH

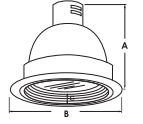

A = 7-1/2"
B = 7-3/8"
C = 1"

PHOTOMETRIC DATA — 6" INCANDESCENT CYLINDER HOUSING

SC6INC-6101CL

TEST NO.: LLI 0205-10B

LAMP: GE 100A19

LUMENS: 1690

EFFICIENCY: 68%

SPACING CRITERIA: 1.36

Candle Power Distribution (Candelas)

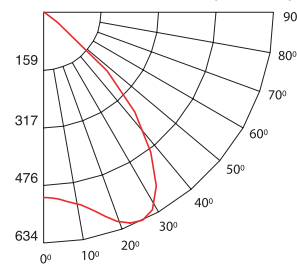

Beam Angle: 100 Degrees	4'	6'	8'	10'	12'
31.8	14.1	8.0	5.1	3.5	28.6'

Distance to Plane Initial Nadir Footcandles Beam Spread
BEAM DIA. MEASURED AT 10% OF NADIR F.C.

Zonal Lumens Summary

Zone	Lumens	%Lamp	%Fixt
0-30°	468.88	27.7	40.8
0-40°	753.61	44.6	65.6
0-60°	1114.15	65.9	97
0-90°	1149.05	68	100
90-120°	0	0	0
90-130°	0	0	0
90-150°	0	0	0
90-180°	0	0	0
0-180°	1149.05	68	100

Total Luminaire Efficiency = 68%

Luminance Data (cd/sq.m)

Angle In Degrees	Average
0-90°	21818
45°	4190
55°	867
65°	698
75°	1057

Zonal Lumen Summary

Zone	Lumens
0-10	40.26
10-20	161.17
20-30	267.45
30-40	284.73
40-50	269.07
50-60	91.47
60-70	25.94
70-80	5.56
80-90	3.41

Candela Tabulation

Candela	Value
0	508.65
1	508.85
3	511.77
5	516.52
7	523.37
9	530.55
11	538.95
13	552.67
15	568.06
17	586.03
19.5	609.23
22.5	626.92
25.5	634.16
29	620.42
33	569.99
37.5	485.62
42.5	371.39
47.5	237.95
55	47.46
65	7.24
75	3.57
85	1.82
90	0

Coefficients of Utilization - Zonal Cavity Method

Effective Floor Cavity Reflectance 20% = PF

RC	80%			70%			50%			30%			10%			0%		
	RW	70%	50%	30%	10%	70%	50%	30%	10%	50%	30%	10%	50%	30%	10%			
0	81	81	81	81	79	79	79	79	76	76	76	72	72	72	69	69	69	68
1	76	74	72	70	74	72	70	69	69	68	66	67	66	64	64	63	63	61
2	71	67	63	60	69	65	62	60	63	60	58	61	59	57	59	57	56	54
3	66	60	56	53	64	59	55	52	57	54	51	56	53	50	54	52	50	48
4	61	55	50	46	60	54	49	46	52	48	45	51	47	45	49	47	44	43
5	57	50	45	41	56	49	44	41	48	43	40	46	43	40	45	42	40	38
6	53	45	40	36	52	45	40	36	44	39	36	43	39	36	42	38	35	34
7	49	42	36	33	48	41	36	33	40	36	32	39	35	32	38	35	32	31
8	46	38	33	30	45	38	33	29	37	32	29	36	32	29	35	32	29	28
9	43	35	30	27	42	35	30	27	34	30	27	33	29	26	33	29	26	25
10	41	32	28	24	40	32	27	24	32	27	24	31	27	24	30	27	24	23

RC - Ceiling Cavity Reflectance

RW - Wall Reflectance