

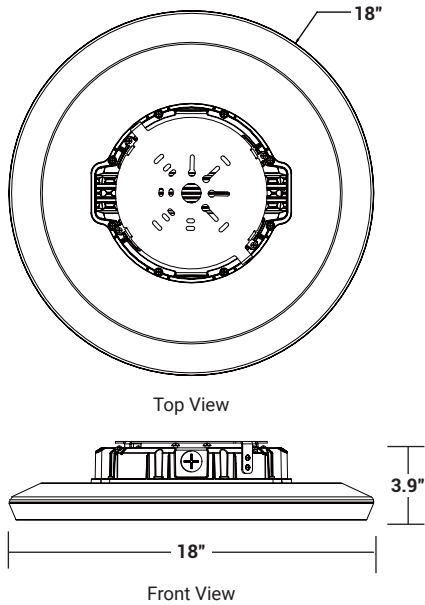

DISTRIBUTION SELECTOR
MULTI LUMEN SELECTOR
EASY 3 COLORS SELECTOR
3000K • 4000K • 5000K



DIMENSIONS



NOMINAL LUMENS	DELIVERED LUMENS	WATTAGE
9000L	9000L	52W
12000L	12000L	78W
15000L	15000L	104W
18000L	18000L	130W

Based on 4000K, 80+ CRI. Actual wattage may vary +/- 5%

FEATURES

THE ULTIMATE IN ADAPTABLE

This super adaptable ceiling mount fixture features 3 adjustable outdoor distributions for versatile, comprehensive application and Dark Sky compliance. An optimal LED configuration allows for even, expansive, and low-glare illumination, while multi-lumen and multi-CCT options cater to different needs and atmospheres. Control ready options available for customization and maximum energy efficiency.

Slim, modern, and ideal for building perimeters, walkways, entryways, parking garages and more. Wet location rated.

Available in pole mount, ceiling mount, and wall arm mount variations.

LUMENS	9000L/12000L/15000L/18000L
CCT	30K/40K/50K
CRI	80+ Standard
COLOR QUALITY	5-Step MacAdam Ellipse
MOUNTING	Ceiling Mount
FINISH	Bronze (BZ)
DIMMING	DIM10 - 10% Flicker-free 0-10V Dimming
DISTRIBUTION	Type III (T3D), Type IV (T4D), and Type V (T5D)
BUG RATING	T3: B3-U0-G3, T4: B4-U0-G4, T5: B4-U0-G2
OPERATING TEMP.	-40°C (-40°F) to 40°C (104°F)
LIFETIME	L80 at 100,000 Hours
PHOTOMETRIC	In accordance with IES LM79-08, LM80 and TM-30, TM-21

MULTI-DISTRIBUTION

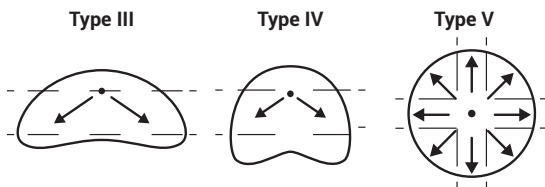

OPTICS

Features a clear polycarbonate lens with individually wrapped optics for optimal beam diffusion. An adjustable distribution switch enables Type III (T3D), Type IV (T4D), and Type V (T5D) distributions for versatile, low-glare illumination in various outdoor settings, and Dark Sky compliance.

Luminaire available in 9000L/12000L/15000L/18000L with 3 selectable color temperatures of 3000K/4000K/5000K to enable different warm to cool moods and atmospheres. Lumen factory set to 18000L. CCT factory set to 5000K.

CONSTRUCTION

Housing constructed from rugged die-cast aluminum for thermal regulation and durability.

Fully sealed and gasketed for outdoor wet location use. Integrated driver located inside luminaire head.

Distribution and multi-lumen/CCT switches located on luminaire side. Audio jack compatible Dust-to-Dawn photocell option available to order separately.

Available in a bronze finish.

MOUNTING

Mounting bracket for surface mounting included with Ceiling Mount configuration.

MAINTENANCE

Fixture can be regularly and safely wiped down to ensure optimal fixture performance.

OPTIONS & ACCESSORIES

- Available to order with optional Light Shield Kit with shield and luminaire cover with 8 pre-drilled holes for shield attachment.

- Optional PIR Motion Sensor offers motion sensitive high/low/off activation; available to order pre-installed. Compatible remote control also available.

- Audio jack compatible ON /OFF photocell option available to order .

See order chart for more details.

DRIVER & ELECTRICAL INFORMATION

Powered by high-quality constant-current LED drivers which are rated for 50 to 60Hz at 120-347V input, produce less than 20% THD, and have a power factor of .90 to 1.00. Thermally protected for increased performance and safety. 6KV standard surge protection.

DIMMING

DIM10 - 10% 0-10V dimming at 120-347V.

WARRANTY

5-year warranty for parts and components (labor not included).

LISTINGS

DLC Premium listed.
UL Listed.
Wet location rated.
Compliant with Dark Sky Requirements at 3000K CCT.

PRODUCT FEATURES

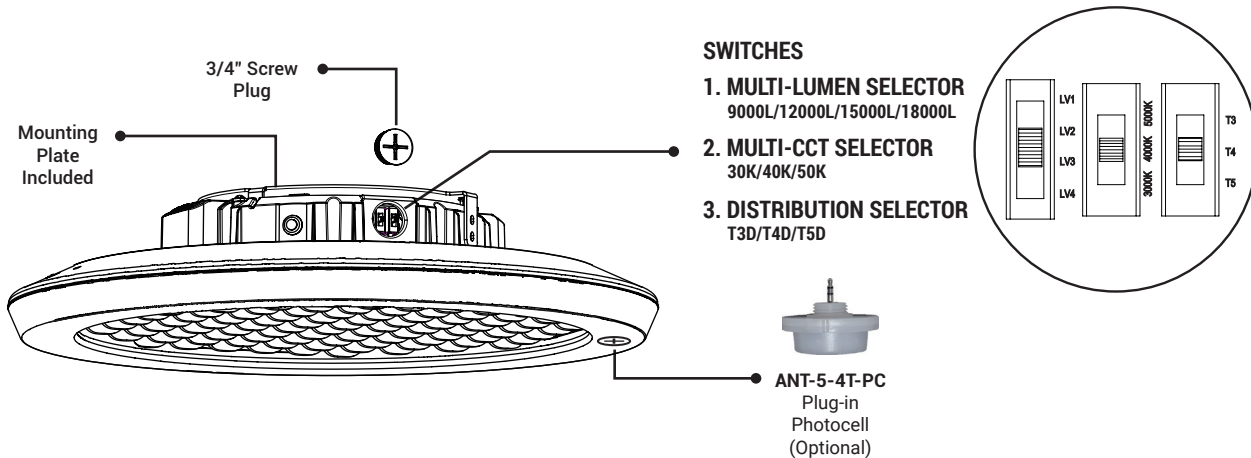

Example: **OPL-106-LED-9000L/12000L/15000L/18000L-DIM10-120-347V-30K/40K/50K-T3D/T4D/T5D-CM-BZ**

SERIES	LUMENS	DIMMING	VOLTAGE	CCT	DISTRIBUTION	MOUNTING	FINISH	OPTION
OPL-106-LED	9000L/12000L/15000L/18000L	DIM10 (0-10V)	120-347V	30K/40K/50K	T3D/T4D/T5D (Type III, IV, V)	CM Ceiling Mount	BZ - Bronze	ANT-5-4T-PC - 12-24V DC Plug and Play Photocell OPL-106-ACC-GSH-BZ - Glare Shield Kit MS-PIR-BI-SR-101 - Bi-level PIR High/Low/Off Motion Sensor MS-RC-G1 - Hand Held Controller Option for MS-PIR-BI-SR-101

OPL-106-LED-9000L-12000L-15000L-18000L-DIM10-120-347V-30K-40K-50K-T3D-T4D-T5D-PTM-BZ-PHC(T3D)

TEST NO.: EL09222534

INPUT WATTS: 129.4

LUMENS: 16545

EFFICACY: 128

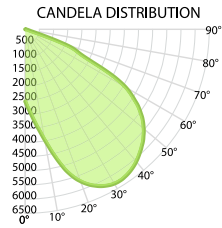

CANDELA TABLE		
	0°	90°
0°	2549	2549
10°	3969	2682
20°	5710	3016
30°	6292	3460
40°	6099	3729
50°	5462	3678
60°	4096	3399
70°	1159	2813
80°	61	80
90°	0	0

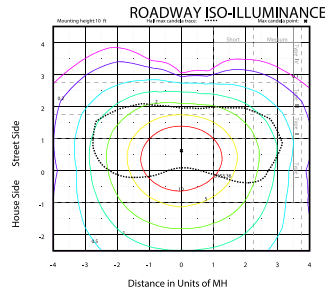

ZONAL LUMEN SUMMARY		
ZONE	LUMENS	% LUMINAIRE
0° - 20°	1139	7%
0° - 30°	2780	17%
0° - 40°	5133	31%
0° - 60°	11203	68%
0° - 80°	16110	97%
0° - 90°	16545	100%

OPL-106-LED-9000L-12000L-15000L-18000L-DIM10-120-347V-30K-40K-50K-T3D-T4D-T5D-PTM-BZ-PHC(T4D)

TEST NO.: EL09222534

INPUT WATTS: 126.7

LUMENS: 17297

EFFICACY: 137

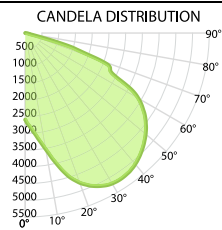

CANDELA TABLE		
	0°	90°
0°	2592	2592
10°	3526	2734
20°	4761	3058
30°	5193	3493
40°	5113	3808
50°	4696	3793
60°	3899	3576
70°	2374	3046
80°	86	99
90°	0	0

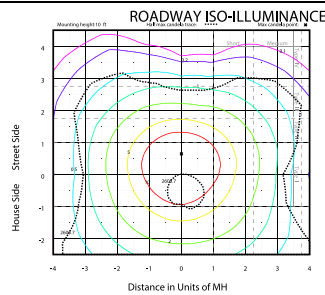

ZONAL LUMEN SUMMARY		
ZONE	LUMENS	% LUMINAIRE
0° - 20°	1119	6%
0° - 30°	2696	16%
0° - 40°	4984	29%
0° - 60°	11184	65%
0° - 80°	16919	98%
0° - 90°	17297	100%

OPL-106-LED-9000L-12000L-15000L-18000L-DIM10-120-347V-30K-40K-50K-T3D-T4D-T5D-PTM-BZ-PHC(T5D)

TEST NO.: EL09222534

INPUT WATTS: 129.3

LUMENS: 16864

EFFICACY: 130

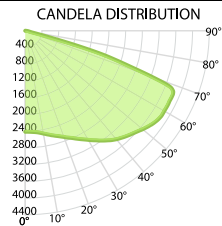

CANDELA TABLE		
	0°	90°
0°	2415	2415
10°	2495	2536
20°	2701	2782
30°	3012	3127
40°	3386	3467
50°	3664	3528
60°	3838	3448
70°	3229	3093
80°	85	93
90°	0	0

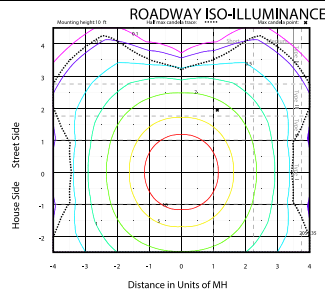

ZONAL LUMEN SUMMARY		
ZONE	LUMENS	% LUMINAIRE
0° - 20°	991	6%
0° - 30°	2353	14%
0° - 40°	4411	26%
0° - 60°	10537	62%
0° - 80°	16752	99%
0° - 90°	16864	100%