

Lumi-Pro Specialty Extrusions

The Lumi-PRO Wall-Mount Direct/Indirect Light Extrusion is a versatile architectural lighting solution designed to deliver clean, balanced illumination both upward and downward. Engineered for modern wall-mounted applications, it creates a refined direct/indirect lighting effect that enhances depth, texture, and visual comfort in any space.

The system features a secure clip-mount installation method. Mounting clips are first fastened directly to the wall surface, allowing the aluminum extrusion to snap firmly into place for a precise, stable, and seamless fit. This design ensures simplified installation while maintaining a clean, professional appearance with no visible fasteners. The result is smooth, glare-reduced light distribution ideal for corridors, feature walls, commercial interiors, and residential applications.













Constructed from high-quality aluminum for optimal heat dissipation and durability, the extrusion is compatible with our LB Series LED Strip Lights, allowing for fully customizable lighting configurations tailored to project requirements.

Example: LP-LGC-DI-SPC-2-8-SI-FTD-L

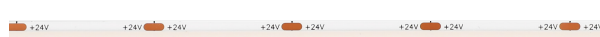
SERIES	EXT. LENGTH	FINISH	OPTICAL LENS
LP-LGC-DI-SPC-2	2 - 2ft 4 - 4ft 8 - 8ft C - Custom	SI - Silver BK - Black WH - White	FTD-L - Flat Diffuser FTO-L - Flat Opal FTC-L - Flat Clear

1.MOQ (minimum order quantity) required for these options, please consult factory.

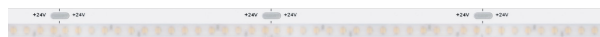
Compatible LB Series-24V LED Strip Lights

LB1000-MN		LB1000-ZZ-ST	
Power 2.9W/ft - Voltage 24V - CRI 90+ - LED Qty 37/ft - Lumens 280lm/ft		Power 3.6W/ft - Voltage 24V - CRI 90+ - LED Qty 43/ft - Lumens 455lm/ft	
LB1000-LR		LB3000-MN-ST	
Power 3.1W/ft - Voltage 24V - CRI 90+ - LED Qty 37/ft - Lumens 295lm/ft		Power 2.1W/ft - Voltage 24V - CRI 90+ - LED Qty 122/ft - Lumens 220lm/ft	
LB1000-ST		LB3000-ST	
Power 7.2W/ft - Voltage 24V - CRI 95+ - LED Qty 72/ft - Lumens 875lm/ft		Power 3W/ft - Voltage 24V - CRI 90+ - LED Qty 146/ft - Lumens 325lm/ft	
LB1000-ST-HO		LB3000-ST-HE	
Power 11W/ft - Voltage 24V - CRI 95+ - LED Qty 72/ft - Lumens 1400lm/ft		Power 5.8W/ft - Voltage 24V - CRI 90+ - LED Qty 88/ft - Lumens 940lm/ft	
LB1000V-ST		LB3000-FC-ST	
Power 6.6W/ft - Voltage 24V - CRI98+ - LED Qty 73/ft - Lumens 890lm/ft		Power 4.6W/ft - Voltage 24V - CRI 90+ - LED Qty 98/ft - Lumens 550lm/ft	
LB1003-ST		LB3000-TWH	
Power 3W/ft - Voltage 24V - CRI90+ - LED Qty 55/ft - Lumens 500lm/ft		Power 6.1W/ft - Voltage 24V - CRI 90+ - LED Qty 195/ft - Lumens 520lm/ft	
LB1000-ST-SC		LB4000-RGB	
Power 7W/ft - Voltage 24V - CRI90+ - LED Qty 61/ft - Lumens 1082lm/ft		Power 6.1W/ft - Voltage 24V - LED Qty 51/ft - Lumens 250lm/ft	



DIMENSIONS

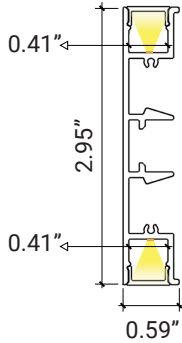

MOUNTING

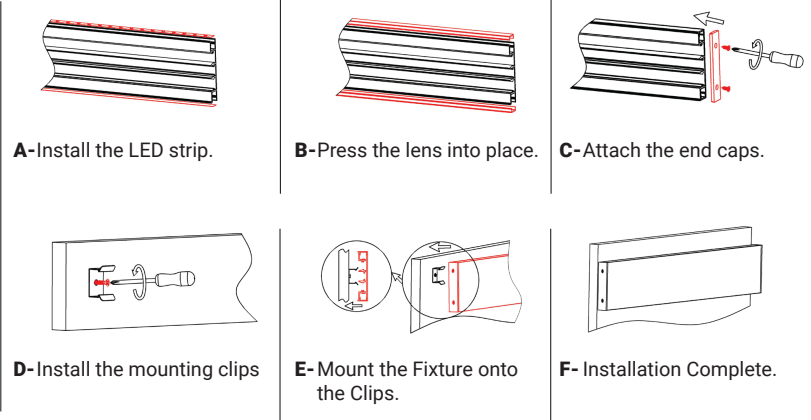

OPTICAL LENSES



FTD-L - Flat Diffuser **INCLUDED**

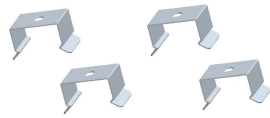

4 Surface Clips **INCLUDED**

END CAPS/INCLUDED



2 End Caps With Holes **INCLUDED**



2 End Caps Without Holes **INCLUDED**

It Can be ordered in 3 different ways.

1. Everything will be shipped separately

RL
• Channel, cover, accessories and tape light will be cut and shipped to your desired length.

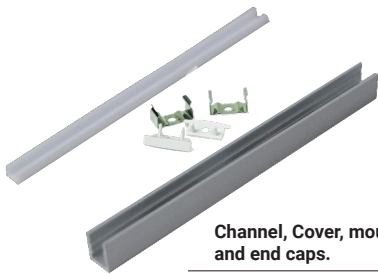

Accessories if ordered.



2. Pre-assembled and shipped separately as two units

PA
• Channel, cover, accessories and tape light will be cut and shipped to your desired length.
• Cover, end caps and clips will be assembled to the channel.
• Wiring accessories will be attached to the tape light.



3. Fully assembled and shipped as a single unit

FA
• Channel, cover, accessories and tape light will be cut and shipped to your desired length.
• Wiring accessories will be attached to the tape light.
• Tape light will be installed into the channel and ready to use.



**COMPATIBLE TAPE LIGHT
Ordering Guide**

Power feed, jumpers and connectors compatible with this channel

	LB1000-MN	LB1000-LR	LB1000-ST	LB1000-ST-HO	LB1000V-ST	LB1003-ST	LB1000-ST-SC	LB1004-ST
Soldered Lead (SL)	✓	✓	✓	✓	✓	✓	✓	X
Soldered Jumper (JPSL)	✓	✓	✓	✓	✓	✓	✓	X
Power Connector (TW)	X	X	X	X	X	X	X	X
Tape Connector (TT)	X	X	X	X	X	X	X	X
Tape Jumper (JP)	X	X	X	X	X	X	X	X
Closed End (CE)	✓	✓	✓	✓	✓	✓	✓	X
DC Connector Male-(DCM)	✓	✓	✓	✓	✓	✓	✓	X
DC Connector Female-(DCF)	✓	✓	✓	✓	✓	✓	✓	X

Power feed, jumpers and connectors compatible with this channel

	LB3000-ST	LB3000-ST-HE	LB3000-FC-ST	LB3000-TWH	LB4000-RGB	LB3000-RGBW	LB4000-RGBTWH	LB4000-RGBW
Soldered Lead (SL)	✓	✓	✓	✓	✓	X	X	X
Soldered Jumper (JPSL)	✓	✓	✓	✓	✓	X	X	X
Power Connector (TW)	X	X	X	X	X	X	X	X
Tape Connector (TT)	X	X	X	X	X	X	X	X
Tape Jumper (JP)	X	X	X	X	X	X	X	X
Closed End (CE)	✓	✓	✓	✓	✓	X	X	X
DC Connector Male-(DCM)	✓	✓	✓	✓	✓	X	X	X
DC Connector Female-(DCF)	✓	✓	✓	✓	✓	X	X	X

SL= Soldered Lead **JPSL**= Soldered Jumper **DCM**=DC Connector Male soldered **DCF**=DC Connector Female soldered
TW=Tape to Wire Power Feed **TT**=Tape to Tape Connector **JP**=Jumper Wire for Connectors **CE**=Closed end no connector

X Not compatible with this channel.

NOTE: The endcap hole should be enlarged to allow wiring to pass through, or the channel may be used without endcaps.



COMPATIBLE TAPE LIGHT Ordering Guide

Power feed, jumpers and connectors compatible with this channel

	LB1000-WL-ST	LB1000-WDM	LB1000-ZZ-ST	LB3000-MN-ST				
Soldered Lead (SL)	X	X	✓	✓				
Soldered Jumper (JPSL)	X	X	✓	✓				
Power Connector (TW)	X	X	X	X				
Tape Connector (TT)	X	X	X	X				
Tape Jumper (JP)	X	X	X	X				
Closed End (CE)	X	X	✓	✓				
DC Connector Male-(DCM)	X	X	✓	✓				
DC Connector Female-(DCF)	X	X	✓	✓				

SL= Soldered Lead **JPSL**= Soldered Jumper **DCM**=DC Connector Male soldered **DCF**=DC Connector Female soldered
TW=Tape to Wire Power Feed **TT**=Tape to Tape Connector **JP**=Jumper Wire for Connectors **CE**=Closed end no connector

X Not compatible with this channel.

NOTE: The endcap hole should be enlarged to allow wiring to pass through, or the channel may be used without endcaps.



Series-LB1000-MN | 280lm/ft - 2.9W/ft
Indoor Strip Light
Width / 0.16"/4mm
37 LEDs/FT

LB1000-MN					
SERIES	WATTAGE	LENGTH	CCT	VOLTAGE	WIRING ACCESSORIES
LB1000-MN	2.9W - 2.9W/ft	16F - 16ft Roll C - Custom	27K - 2700K 30K - 3000K 35K - 3500K 40K - 4000K 50K - 5000K	24V - 24V	DCM - Wire to Wire Male Connector DCF - Wire to Wire Female Connector SL-2 - Soldered Lead JP SL-2 - Soldered Jumper
SHIPPING OPTIONS					
RL - Rolls 16ft PA - Pre-Assembled FA - Fully Assembled					

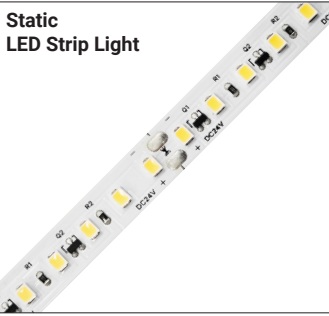

Series-LB1000-LR | 295lm/ft - 3.1W/ft
Indoor Strip Light
Width / 0.39"/10mm
37 LEDs/FT

LB1000-LR					
SERIES	WATTAGE	LENGTH	CCT	VOLTAGE	WIRING ACCESSORIES
LB1000-LR	3.1W - 3.1W/ft	52F - 52ft Roll C - Custom	30K - 3000K 40K - 4000K 50K - 5000K	24V - 24V	TT10-2 - Tape to Tape Connector TW10-2 - Tape to Wire Connector JP10-2 - Tape to Tape Jumper DCM - DC Male Connector DCF - DC Female Connector SL-2 - Soldered Lead JP SL-2 - Soldered Jumper
SHIPPING OPTIONS					
RL - Rolls 52ft PA - Pre-Assembled FA - Fully Assembled					



Series-LB1000-ST | 235lm/ft - 1.9W/ft
Indoor Strip Light
Width / 0.39"/10mm
72 LEDs/FT

LB1000-ST					
SERIES	WATTAGE	LENGTH	CCT	VOLTAGE	WIRING ACCESSORIES
LB1000-ST	1.9W - 1.9W/ft 4.6W - 4.6W/ft 7.2W - 7.2W/ft	16F - 16ft Roll C - Custom	27K - 2700K 30K - 3000K 35K - 3500K 40K - 4000K 50K - 5000K 60K - 6000K	24V - 24V	TT10-2T - Tape to Tape Connector TW10-2T - Power Connector JP10-2T - Tape to Tape Jumper DCM - Wire to Wire Male Connector DCF - Wire to Wire Female Connector SL-2 - Soldered Lead JP SL-2 - Soldered Jumper
SHIPPING OPTIONS					
RL - Rolls 16ft PA - Pre-Assembled FA - Fully Assembled					

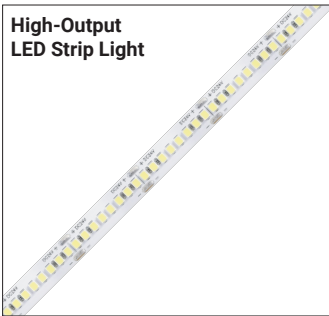

Series-LB1000-ST-HO | 1120lm/ft - 9W/ft
Indoor Strip Light
Width / 0.39"/10mm
72 LEDs/FT

LB1000-ST-HO					
SERIES	WATTAGE	LENGTH	CCT	VOLTAGE	WIRING ACCESSORIES
LB1000-ST-HO	9W - 9W/ft 11W - 11W/ft	16F - 16ft Roll C - Custom	27K - 2700K 30K - 3000K 35K - 3500K 40K - 4000K 50K - 5000K 60K - 6000K	24V - 24V	TT10-2T - Tape to Tape Connector TW10-2T - Power Connector JP10-2T - Tape to Tape Jumper DCM - Wire to Wire Male Connector DCF - Wire to Wire Female Connector SL-2 - Soldered Lead JP SL-2 - Soldered Jumper
SHIPPING OPTIONS					
RL - Rolls 16ft PA - Pre-Assembled FA - Fully Assembled					



**CRI 98+
LED Strip Light**



Series-LB1000V-ST | 890lm/ft-6.6W/ft
Indoor Strip Light
Width / 0.39" / 10mm
73 LEDs/FT

SERIES	WATTAGE	LENGTH	CCT	VOLTAGE	WIRING ACCESSORIES
LB1000V-ST	6.6W - 6.6W/ft	16F - 16ft Roll C - Custom	27K - 2700K 30K - 3000K 35K - 3500K 40K - 4000K 50K - 5000K	24V - 24V	TW10-2T - Tape to Wire Connector JP10-2T - Tape to Tape Jumper DCM - DC Male Connector DCF - DC Female Connector SL-2 - Soldered Lead JP1SL-2 - Soldered Jumper

SHIPPING OPTIONS

- RL - Rolls 16ft
- PA - Pre-Assembled
- FA - Fully Assembled

**High Efficiency
LED Strip Light**

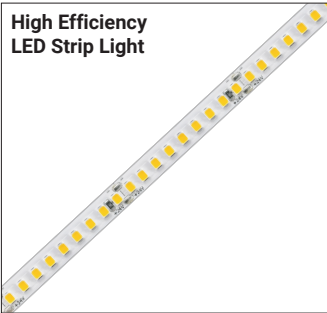

Series-LB1003-ST | 500lm/ft - 3W/ft
Indoor Strip Light
Width / 0.3" / 8mm
55 LEDs/FT

SERIES	WATTAGE	LENGTH	CCT	VOLTAGE	WIRING ACCESSORIES
LB1003-ST	3W - 2.9W/ft	16F - 16ft Roll C - Custom	27K - 2700K 30K - 3000K 35K - 3500K 40K - 4000K 50K - 5000K 65K - 6500K	24V - 24V	TW8-2 - Power Connector JP8-2 - Tape to Tape Jumper DCM - Wire to Wire Male Connector DCF - Wire to Wire Female Connector SL-2 - Soldered Lead JP1SL-2 - Soldered Jumper

SHIPPING OPTIONS

- RL - Rolls 16ft
- PA - Pre-Assembled
- FA - Fully Assembled

**Single Cut
LED Strip Light**



Series-LB1000-ST-SC | 1082lm/ft-7W/ft
Indoor Strip Light
Width / 0.3" / 8mm
61 LEDs/FT

SERIES	WATTAGE	LENGTH	CCT	VOLTAGE	WIRING ACCESSORIES
LB1000-ST-SC	7W - 7.3W/ft	13F - 13ft Roll C - Custom	27K - 2700K 30K - 3000K 35K - 3500K 40K - 4000K 50K - 5000K 65K - 6500K	24V - 24V	TW8-2 - Tape to Wire Connector JP8-2 - Tape to Tape Jumper DCM - DC Male Connector DCF - DC Female Connector SL-2 - Soldered Lead JP1SL-2 - Soldered Jumper

SHIPPING OPTIONS

- RL - Rolls 16ft
- PA - Pre-Assembled
- FA - Fully Assembled

**COB Static White
LED Strip Light**



Series-LB3000-ST | 325lm/ft - 3W/ft
Indoor Strip Light
Width / 0.3"/8mm
146 LEDs/FT

SERIES	WATTAGE	LENGTH	CCT	VOLTAGE	WIRING ACCESSORIES
LB3000-ST	3W - 3W/ft	16F - 16ft Roll C - Custom	27K - 2700K 30K - 3000K 35K - 3500K 40K - 4000K 50K - 5000K 60K - 6000K	24V - 24V	TT8-2C - Tape to Tape Connector TW8-2C - Power Connector JP8-2C - Tape to Tape Jumper DCM - Wire to Wire Male Connector DCF - Wire to Wire Female Connector SL-2 - Soldered Lead JP1SL-2 - Soldered Jumper

SHIPPING OPTIONS

- RL - Rolls 16ft
- PA - Pre-Assembled
- FA - Fully Assembled



IP20

COMPATIBLE TAPE LIGHT

LP-LGC-DI-SPC-2

Lumi-PRO Wall-Mount Direct/Indirect Light Aluminum Extrusion

Refer to the tape light spec sheet for detailed information.



Series-LB3000-ST-HE | 940lm/ft-5.8W/ft
Indoor Strip Light
Width / 0.39" / 10mm
88 LEDs/FT

LB3000-ST-HE					
SERIES	WATTAGE	LENGTH	CCT	VOLTAGE	WIRING ACCESSORIES
LB3000-ST-HE	5.8W - 5.8W/ft	16F - 16ft Roll C - Custom	27K - 2700K 30K - 3000K 35K - 3500K 40K - 4000K 50K - 5000K	24V - 24V	TT10-2BC - Tape to Tape Connector TW10-2BC - Tape to Wire Connector JP10-2BC - Tape to Tape Jumper DCM - DC Male Connector DCF - DC Female Connector SL-2 - Soldered Lead JPSL-2 - Soldered Jumper

SHIPPING OPTIONS
RL - Rolls 16ft PA - Pre-Assembled FA - Fully Assembled



Series-LB3000-FC-ST | 550lm/ft-4.6W/ft
Indoor Strip Light
Width / 0.39" / 10mm
98 LEDs/FT

LB3000-FC-ST					
SERIES	WATTAGE	LENGTH	CCT	VOLTAGE	WIRING ACCESSORIES
LB3000-FC-ST	4.6W - 4.6W/ft	16F - 16ft Roll C - Custom	27K - 2700K 30K - 3000K 35K - 3500K 40K - 4000K 50K - 5000K	24V - 24V	TT10-2BC - Tape to Tape Connector TW10-2BC - Tape to Wire Connector JP10-2BC - Tape to Tape Jumper DCM - DC Male Connector DCF - DC Female Connector SL-2 - Soldered Lead JPSL-2 - Soldered Jumper

SHIPPING OPTIONS
RL - Rolls 16ft PA - Pre-Assembled FA - Fully Assembled



Series-LB3000-TWH | 520lm/ft - 6.1W/ft
Indoor Strip Light
Width / 0.39"/10mm
195 LEDs/FT

LB3000					
SERIES	WATTAGE	LENGTH	TECHNOLOGY	VOLTAGE	WIRING ACCESSORIES
LB3000	6.1W - 6.1W/ft	16F - 16ft Roll C - Custom	TWH-65K-27K - TWH/6500K-2700K	24V - 24V	TW10-3C - Power Connector JP10-3C - Tape to Tape Jumper SL-3 - Soldered Lead JPSL-3 - Soldered Jumper

SHIPPING OPTIONS
RL - Rolls 16ft PA - Pre-Assembled FA - Fully Assembled



Series-LB3000-MN-ST | 220lm/ft -2W/ft
Indoor Strip Light
Width / 0.16"/4mm
122 LEDs/FT

LB3000-MN-ST					
SERIES	WATTAGE	LENGTH	CCT	VOLTAGE	WIRING ACCESSORIES
LB3000-MN-ST	2W - 2.1W/ft	16F - 16ft Roll C - Custom	27K - 2700K 30K - 3000K 40K - 4000K 65K - 6500K	24V - 24V	DCM - Wire to Wire Male Connector DCF - Wire to Wire Female Connector SL-2 - Soldered Lead JPSL-2 - Soldered Jumper

SHIPPING OPTIONS
RL - Rolls 16ft PA - Pre-Assembled FA - Fully Assembled



**ZIG-ZAG
LED Strip Light**

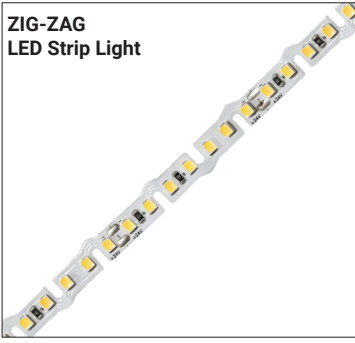

Series-LB1000-ZZ-ST | 455lm/ft - 3.6W/ft
Indoor Strip Light
Width / 0.39" / 10mm
43 LEDs/FT

LB1000-ZZ-ST					
--------------	--	--	--	--	--

SERIES	WATTAGE	LENGTH	CCT	VOLTAGE	WIRING ACCESSORIES
LB1000-ZZ-ST	3.6W - 3.6W/ft	16F - 16ft Roll C - Custom	27K - 2700K 30K - 3000K 35K - 3500K 40K - 4000K 50K - 5000K 65K - 6500K	24V - 24V	TW8-2 - Tape to Wire Connector JP8-2 - Tape to Tape Jumper DCM - DC Male Connector DCF - DC Female Connector SL-2 - Soldered Lead JPSL-2 - Soldered Jumper

SHIPPING OPTIONS

- RL - Rolls 16ft
- PA - Pre-Assembled
- FA - Fully Assembled

**RGB
LED Strip Light**

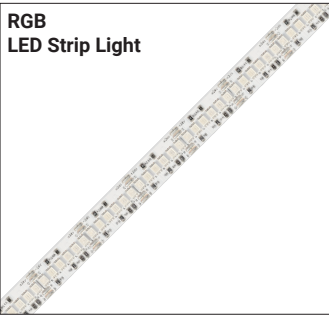

Series-LB4000-RGB | 250lm/ft - 6.1W/ft
Indoor Strip Light
Width / 0.39" / 10mm
51 LEDs/FT

LB4000					
--------	--	--	--	--	--

SERIES	WATTAGE	LENGTH	COLOR	VOLTAGE	WIRING ACCESSORIES
LB4000	6.1W - 6.1W/ft	16F - 16ft Roll C - Custom	RGB - RGB	24V - 24V	TT10-4 - Tape to Tape Connector TW10-4 - Power Connector JP10-4 - Tape to Tape Jumper SL-4 - Soldered Lead JPSL-4 - Soldered Jumper

SHIPPING OPTIONS

- RL - Rolls 16ft
- PA - Pre-Assembled
- FA - Fully Assembled

