



Anti-Glare LED Linear Light

The Lumi-PRO Anti-Glare Family is a 24V DC linear lighting system designed for projects that require visual continuity and layout flexibility. Its compact profile allows for the creation of multiple architectural configurations, enabling endless design possibilities and precise customization of lighting layouts.

Featuring a compact 0.52" aperture and a 2.17" flange-to-flange width, this luminaire delivers refined, uniform linear illumination for both commercial and residential interiors. Available in black, white, or custom RAL finishes, the Lumi-PRO Anti-Glare LED Profile is engineered for recessed trimless installation, providing a clean, seamless architectural appearance.

The complete Architectural LED Linear System includes a flat diffuser lens and end caps. Two anti-glare options are available—Honeycomb Louver or Blade Louver—to enhance visual comfort while maintaining a clean, modern aesthetic. The combination of the flat diffuser lens with the selected louver provides smooth, controlled light distribution, making the system ideal for visually sensitive environments.

Designed for indoor use only, the Anti-Glare System is well suited for applications in commercial, residential, and hospitality, environments.

TECHNICAL DETAILS

INPUT VOLTAGE	24V
POWER	4.6 W/ft, 7.3 W/ft
EFFICIENCY lm/W	120 lm/W, 150 lm/W
CRI	90+
DISTRIBUTION PATTERNS	Blade Louver, Honeycomb Louver
CCT	27K, 30K, 35K, 40K, 50K
LENGTHS	1', 2', 4', 8', or continuous custom configurations
FINISH	Black, White, Custom RAL
DIMMING & CONTROLS	0-10V Flicker-Free Dimming (DIM10), LUTH, DIMTR, DALI, BLE

Color Temp.	4.6 W/ft
2700K	495 lm/ft
3000K	520 lm/ft
3500K	520 lm/ft
4000K	550 lm/ft
5000K	550 lm/ft
Color Temp.	7.3 W/ft
2700K	1030 lm/ft
3000K	1040 lm/ft
3500K	1060 lm/ft
4000K	1100 lm/ft
5000K	1100 lm/ft

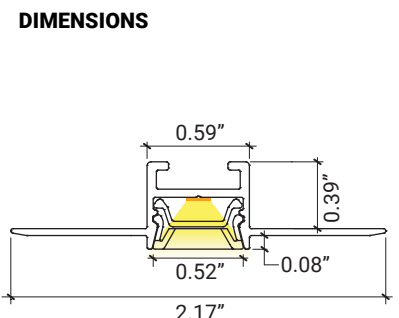



Anti-Glare LED Linear Light

CONSTRUCTION

Housing constructed from a single-piece extruded aluminum profile with plastic end caps. Optical components consist of a standard diffuser lens, with optional honeycomb or blade louvers, all manufactured from polycarbonate to provide installation flexibility.

LED MODULE PERFORMANCE

Light source options include a 4.6 W/ft COB LED strip with 98 LEDs/ft and a 7.3 W/ft 2835 SMD LED strip with 61 LEDs/ft.

The luminaires are equipped with 2-step MacAdam ellipse LEDs, providing consistent color across all fixtures with a CRI of 90+. The LEDs are available in multiple Kelvin temperature options.

OPTICS & PERFORMANCE

Optical options include a standard diffuser lens, with optional honeycomb louver or blade louver configurations to provide controlled light distribution and glare mitigation. Lenses and louvers are manufactured from polycarbonate for durability and long-term optical stability.

Standard UGR<10. The luminaire delivers uniform illumination with minimal pixelation, depending on light source selection and optical configuration. Precision-engineered optics ensure consistent performance across continuous runs and custom-shaped lighting layouts.

CRM INSTALLATION

The Anti-Glare recessed trimless aluminum LED system is designed for seamless integration into drywall or plaster ceilings and walls. The profile allows for a flush, trimless finish, creating a continuous and clean lighting appearance.

For both continuous and single-run configurations, the first section is supplied with a standard 4 ft hardwire power cable.

FINISH

Luminaires are available in a powder-coated black or white post-paint finish. Custom RAL colors are also available upon request. Please consult the factory to confirm available custom color options.

POWER FEED

For both continuous and single-run configurations, the first luminaire section is supplied with a standard 4 ft hardwire power feed. Side or top power feed entry options are available to accommodate any layout and installation conditions.

DRIVER ELECTRICAL INFORMATION

The Anti-Glare System is powered by constant-voltage drivers rated for 50/60 Hz operation with a 120–277V input and a 24V output. The drivers deliver less than 20% THD, a power factor of 0.90%, and include thermal protection for added safety.

Drivers may be remotely mounted and are available with 0–10 V (1% minimum) dimming, phase-cut dimming (forward and reverse phase), DALI, Bluetooth, and Lutron dimming options.

DIMMING AND DRIVER INFORMATION

DIM10 - 0-10V dimming on either MVOLT 120, 277V. Dimmable down to 1% of initial lumens, standard.

DIMTR - Electronic low voltage dimming. Available in 120V.

DALI - DALI DT6 dimming down to 1%

LUTH-Lutron ecosystem with soft fade to black down to 1% dimming

BLE - Luminaires may be controlled, grouped, scheduled or placed in scenes and or zones Via Cassambi Bluetooth 4.0 App.

WARRANTY

5-year warranty for parts and components (labor not included)

LISTINGS

RoHS compliant

cUL Class 2 wiring

Title 24 JA8 compliant with universal power supplies

LOUVER OPTIONS

White Finish Available



PC-BL-1
Blade Louver

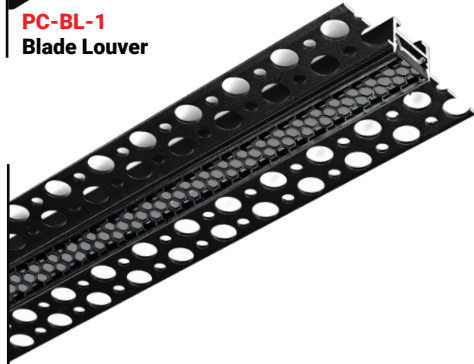

PC-HCL-1
Honeycomb Louver



Frosted Diffuser Lens
INCLUDED

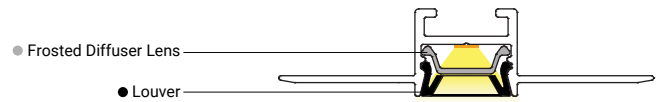
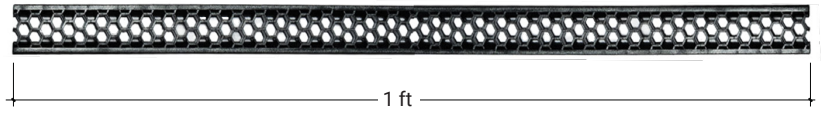
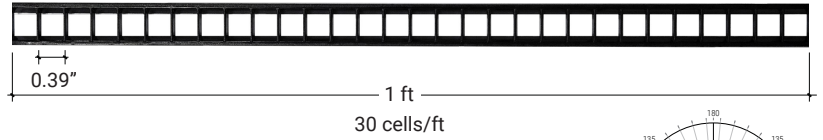

MOUNTING

Recessed Trimless

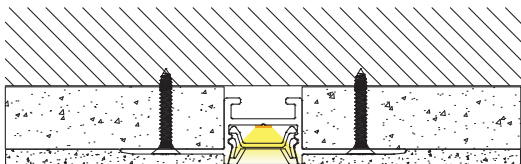

RUN CHART GUIDE

Run length (ft)	Section Lengths
9	5 + 4
10	6 + 4
11	7 + 4
12	8 + 4
13	8 + 5
14	8 + 6
15	8 + 7
16	8 + 8
17	8 + 5 + 4
18	8 + 6 + 4
19	8 + 7 + 4
20	8 + 8 + 4

Run length (ft)	Section Lengths
21	8 + 8 + 5
22	8 + 8 + 6
23	8 + 8 + 7
24	8 + 8 + 8
25	8 + 8 + 5 + 4
26	8 + 8 + 6 + 4
27	8 + 8 + 7 + 4
28	8 + 8 + 8 + 4
29	8 + 8 + 8 + 5
30	8 + 8 + 8 + 6
31	8 + 8 + 8 + 7
32	8 + 8 + 8 + 8

ORDERING TABLE

Example: LP-AG-RTL-075-4.6W-CR-22.6-PC-BL-1-BK-DIM10-24V-35K-90-BK-SPF

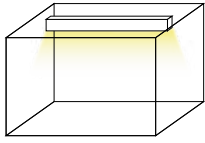
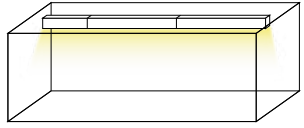
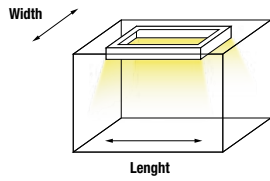
SERIES	WATTAGE	SHAPE	TOTAL RUN	LOUVER OPTION	DIMMING
LP-AG-RTL-075	4.6W - 4.6W 7.3W - 7.3W	S - Single Run 	1 - 1f 2 - 2f 4 - 4f 8 - 8f ¹ CUS - Custom	PC-BL-1-BK - Polycarbonate Blade Louver-Black PC-HCL-1-BK - Polycarbonate Honeycomb Louver-Black PC-BL-1-WH - Polycarbonate Blade Louver-White PC-HCL-1-WH - Polycarbonate Honeycomb Louver-White (Blank) - Frosted Diffuser Lens (Standard)	DIM10 - 0-10V Dimming DIMTR - Triac & Elv LUTH - Lutron HiLum DALI - DALI DT6
		CR - Continuous Run 	XX.YY XX = length in feet YY = inches Example: 22.6 = 22 ft 6 in		
		REC - Rectangle 	XX.YY XX = width in feet YY = inches Example: 22.6 = 22 ft 6 in XX.YY XX = length in feet YY = inches Example: 14.5 = 14 ft 5 in		
		CUS - Custom Sketch your design on the next page			

VOLTAGE	CCT	CRI	FINISH	POWER FEED ENTRY	EMERGENCY (REMOTE)
24V - 24V	27K - 2700K 30K - 3000K 35K - 3500K 40K - 4000K 50K - 5000K	90 - 90CRI	BK - Black WH - White RAL - Consult factory	SPF - Side Power Feed TPF - Top Power Feed	EMG-LED-15W-HV

1-Lengths adjustable in increments of 1".

Factory drawings will be provided and must be reviewed, signed, and approved prior to production.





Sketch your design using the grid space below
and email it to kay@iuseelite.com

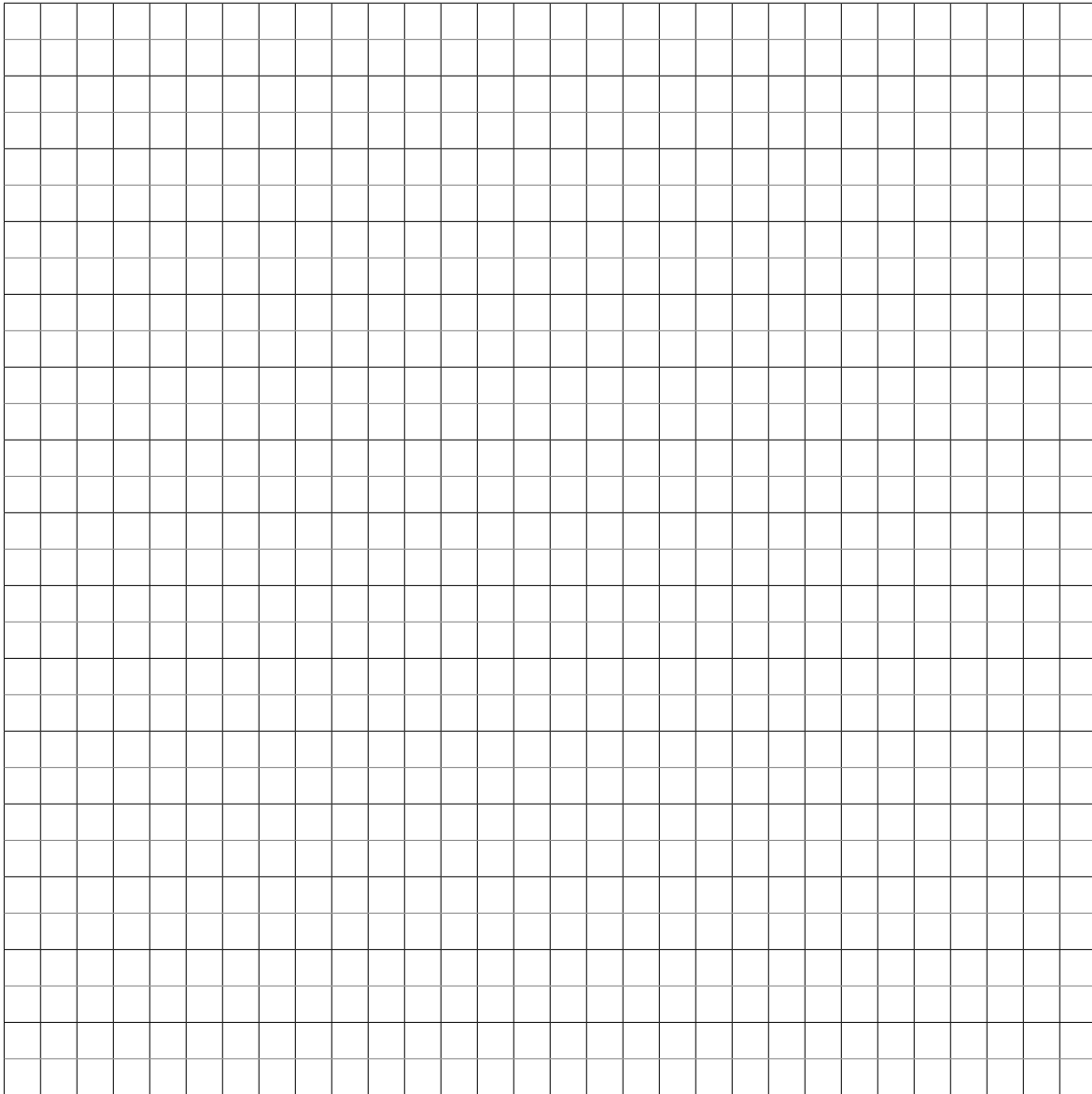

Anti-Glare LED Linear Light

Factory drawings will be provided and must be reviewed, signed, and approved prior to production.

TM30

4.6 W/ft
3500K
View Angle:2 Deg

