

NEW

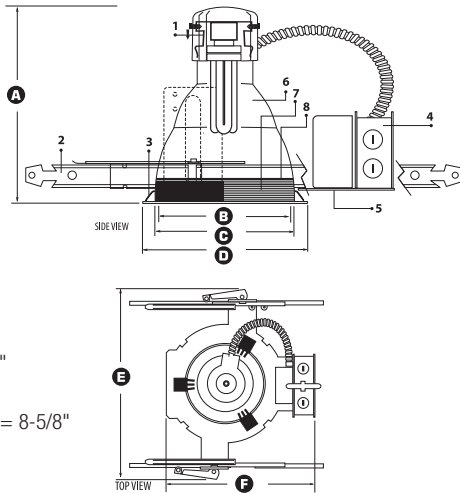

TRIM: 7101 REFLECTOR



- A. Min. Height** = 10-3/8"
- B. Trim Aperture** = 7-3/16"
- C. Cut-out** = 7-7/16"
- D. Trim Outside Diameter** = 8-5/8"
- E. Width** = 14-5/8"
- F. Length** = 13"

DESCRIPTION

- 1. LAMP HOLDER** - Die-cast aluminum lamp holder effectively provides heat dissipation and ventilation. Unitized optics guarantees proper trim to housing installation. Tool-less installation adjustability from either outside the housing or inside the housing.
- 2. MOUNTING BRACKET** - Constructed from 16-gauge steel. Can be installed with 3/4" or 1-1/2" lathing channel, 1/2" EMT, or with optional C-channel mounting bars (Part# BP31) ordered separately. Housing can be adjusted from the inside of the ceiling.
- 3. RETAINING SPRINGS** - Precision tooled springs secure trim to mounting frame, for effortless and tool-less installation.
- 4. JUNCTION BOX/BALLAST** - UL listed for through-branch circuit wiring and has four 1/2" KO's, one 3/4" KO and four Romex knockouts with pry-out slots and strain clamps. Ballast and Junction Box are accessible from below, no tools required. Ballast supplied is manufactured by Philips Advance, Universal Technologies or Lutron Electronics.
- 5. MOUNTING FRAME** - Die-formed construction for maximum heat dissipation and rust protection.

OPTICS

- 6. REFLECTOR** - Self-flanged .050" aluminum reflector with low iridescent finish. Reflector provides 45-degree lamp-to-reflector image cutoff.
- 7. GROOVE BAFFLE** - Self-flanged one-piece aluminum with concentric rings.
- 8. LENS** - Choice of either tempered clear, tempered prismatic or tempered frosted lens fastened with two torsion springs for easy re-lamping. /UL listed for wet or damp location.

LISTING

UL listed for through-branch circuit wiring and damp locations. Wet location only with lens trims.

Please visit our website for the most updated information on each product.



LAMP BASE GUIDE (Sockets will accept all designated lamp bases listed.)				
13W	18W	26W	32W	42W
G24q-1 GX24q-1	G24q-2 GX24q-2	G24q-3 GX24q-3 GX24q-4	GX24q-3 GX24q-4	GX24q-4

HV7PL - ITEM SELECTOR: (Please check the boxes below for the option desired)

WATTAGE	BALLAST	VOLTAGE	EMERGENCY OPTIONS	TRIM TYPE & DESCRIPTION	REFLECTOR	BAFFLE	GLASS
<input type="checkbox"/> 1X13	<input type="checkbox"/> (E) Electronic ¹	<input type="checkbox"/> MVOLT	<input type="checkbox"/> EMG 750 (750 lm) ⁶	<input type="checkbox"/> 7101 Reflector	<input type="checkbox"/> CL-WH	<input type="checkbox"/> W-CL-WH	<input type="checkbox"/> Blue
<input type="checkbox"/> 1X18	<input type="checkbox"/> (S) Energy Star ²	(120/277)	<input type="checkbox"/> EMG 1300 (1300 lm) ⁶	<input type="checkbox"/> 7102 Baffle/Reflector	<input type="checkbox"/> CL-SCH	<input type="checkbox"/> P-CL-WH	<input type="checkbox"/> Green
<input type="checkbox"/> 1X26		<input type="checkbox"/> 120	<input type="checkbox"/> INTG 750 (750 lm) ⁷	<input type="checkbox"/> 7103 Ref./Fres. Gls. Lns.	<input type="checkbox"/> SHZ-SHZ	<input type="checkbox"/> W-WH	<input type="checkbox"/> Red
<input type="checkbox"/> 1X32		<input type="checkbox"/> 277	<input type="checkbox"/> INTG 1300 (1300 lm) ⁷	<input type="checkbox"/> 7104 Ref./Pris. Gls. Lns.	<input type="checkbox"/> SHZ-WH	<input type="checkbox"/> P-WH	<input type="checkbox"/> Frost
<input type="checkbox"/> 1X42			<input type="checkbox"/> ICE-1300 (1300 lm) ¹⁰	<input type="checkbox"/> 7105 Baf./Fres. Gls. Lns.	<input type="checkbox"/> WT-WH		
			<input type="checkbox"/> EMG-SD-1300 (1300 lm) ¹⁴	<input type="checkbox"/> 7106 Baf./Pris. Gls. Lns.	<input type="checkbox"/> W-WH		
	DIMMING		OTHER OPTIONS	<input type="checkbox"/> 7107 Wall Wash Ref.	<input type="checkbox"/> MB-WH		
	<input type="checkbox"/> Mark 7 ³		<input type="checkbox"/> FUSE ¹¹	<input type="checkbox"/> 7108 Crossblade Ref.			
	<input type="checkbox"/> Mark 10 ⁴		<input type="checkbox"/> RIF ¹²	<input type="checkbox"/> 7112 Baf./Frost Gls. Lns.			
	<input type="checkbox"/> Lut-E (EC3D) ⁵			<input type="checkbox"/> 7113 Baf./Tem. Clr. Gls.			
				<input type="checkbox"/> 7114 Ref./Frost Gls. Lns.			
				<input type="checkbox"/> 7115 Ref./Tem. Clr. Gls.			
				<input type="checkbox"/> 7116 Ref./Pris. Plas. Lns.			
				<input type="checkbox"/> 7117 Baf./Pris. Plas. Lns.			
				<input type="checkbox"/> 7118 Ref./Tem. Clr. Plas.			
				<input type="checkbox"/> 7119 Baf./Tem. Clr. Plas.			
				<input type="checkbox"/> 7109 Deco Glass Ring			
				<input type="checkbox"/> 7110 Double Ring			
				<input type="checkbox"/> 7111 Triple Ring			
				<input type="checkbox"/> 7125 Central Etched Float Gls.			
				<input type="checkbox"/> 7126 Diff. Screen Wall Wash			

REFLECTOR	BAFFLE	GLASS
CL Clear	WH White	Only available on XX09, XX10 and XX11 series.
SHZ Satin Haze (Low Iridescent)	P Black	
WT Wheat	RING	
MB Black	WH Self-Flange White	
W White	SCH Self-Flange Chrome	
	SHZ Satin Haze	

*For custom baffle, reflector, trim ring, glass color and lens options, please consult factory.

¹ - **Electronic** = Not available on 9W only • ² - **(S) Energy Star** = Available on selected fixtures only, please see list above • ³ - **MARK 7** = Must specify voltage, not compatible with Emergency Options • ⁴ - **MARK 10** = Not available on 9W, 13W, 57W, 70W, must specify voltage, not compatible with Emergency Options • ⁵ - **LUT-E (EC3D)** = Not available on 9W, 13W, 57W, 70W, must specify voltage • ⁶ - **EMG** = Emergency battery pack w/ remote test switch • ⁷ - **INTG** = Emergency battery pack w/ integral (reflector) test switch • ⁸ - **EMG-D** = Emergency battery pack w/ remote test switch for damp location • ⁹ - **INTG-D** = Emergency battery pack w/ integral(reflector) test switch for damp location • ¹⁰ - **ICE** = Emergency battery pack w/ remote test switch operating between -18°C and 55°C • ¹¹ - **FUSE** = Single slow-blow fuse • ¹² - **RIF** = Radio interference filter) • ¹³ - **Magnetic** = Available on 9W, 13W, 18W & 26W fixtures only • ¹⁴ - **SD** = Emergency battery pack w/ Self-Diagnostic

Specifications:

HV7PL	-	-	-	-	-	-	-	-	-
WATT	BALLAST	VOLTAGE	EMERGENCY	OPTIONS	TRIM TYPE	REFLECTOR	BAFFLE	GLASS	

Sample of Catalog Number: HV7PL-1X32-E-MVOLT-EMG750-7101-CL-WH

7101 - _____
Reflector



TRIM FINISH:
 • CL-WH • WT-WH
 • CL-SCH • W-WH
 • SHZ-SHZ • MB-WH
 • SHZ-WH



A = 7-7/8"
B = 8-3/8"

7102 - _____
Baffle with Reflector



TRIM FINISH:
 • W-CL-WH
 • P-CL-WH



A = 7-7/8"
B = 8-3/8"
C = 1"

7107 - _____
Wall Wash Reflector



TRIM FINISH:
 • CL-WH • WT-WH
 • CL-SCH • W-WH
 • SHZ-SHZ • MB-WH
 • SHZ-WH



A = 7-7/8"
B = 8-3/8"

7108 - _____
Crossblade Reflector



TRIM FINISH:
 • CL-WH • WT-WH
 • CL-SCH • W-WH
 • SHZ-SHZ • MB-WH
 • SHZ-WH

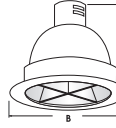

A = 7-7/8"
B = 8-3/8"

7103 - _____
Reflector with Fresnel Glass Lens



TRIM FINISH:
 • CL-WH • WT-WH
 • CL-SCH • W-WH
 • SHZ-SHZ • MB-WH
 • SHZ-WH

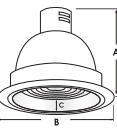

A = 7-7/8"
B = 8-3/8"
C = 1"

7104 - _____
Reflector with Prismatic Glass Lens



TRIM FINISH:
 • CL-WH • WT-WH
 • CL-SCH • W-WH
 • SHZ-SHZ • MB-WH
 • SHZ-WH

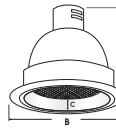

A = 7-7/8"
B = 8-3/8"
C = 1"

7114 - _____
Reflector with Frosted Glass Lens



TRIM FINISH:
 • CL-WH • WT-WH
 • CL-SCH • W-WH
 • SHZ-SHZ • MB-WH
 • SHZ-WH



A = 7-7/8"
B = 8-3/8"
C = 1"

7115 - _____
Reflector with Tempered Clear Glass



TRIM FINISH:
 • CL-WH • WT-WH
 • CL-SCH • W-WH
 • SHZ-SHZ • MB-WH
 • SHZ-WH

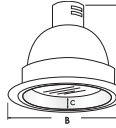

A = 7-7/8"
B = 8-3/8"
C = 1"

7105 - _____
Baffle with Fresnel Glass Lens



TRIM FINISH:
 • W-WH
 • P-WH



A = 7-7/8"
B = 8-3/8"
C = 1"

7106 - _____
Baffle with Prismatic Glass Lens



TRIM FINISH:
 • W-WH
 • P-WH



A = 7-7/8"
B = 8-3/8"
C = 1"

7112 - _____
Baffle with Frosted Glass Lens



TRIM FINISH:
 • W-WH
 • P-WH

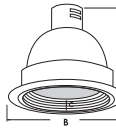

A = 7-7/8"
B = 8-3/8"
C = 1"

7113 - _____
Baffle with Tempered Clear Glass



TRIM FINISH:
 • W-WH
 • P-WH



A = 7-7/8"
B = 8-3/8"
C = 1"

7116 - _____
Reflector with Prismatic Plastic Lens



TRIM FINISH:
 • CL-WH • WT-WH
 • CL-SCH • W-WH
 • SHZ-SHZ • MB-WH
 • SHZ-WH

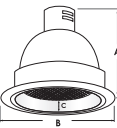

A = 7-7/8"
B = 8-3/8"
C = 1"

7117 - _____
Baffle with Prismatic Plastic Lens

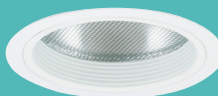

TRIM FINISH:
 • W-WH
 • P-WH

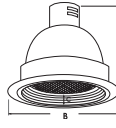

A = 7-7/8"
B = 8-3/8"
C = 1"

7118 - _____
Reflector with Tempered Clear Plastic



TRIM FINISH:
 • CL-WH • WT-WH
 • CL-SCH • W-WH
 • SHZ-SHZ • MB-WH
 • SHZ-WH

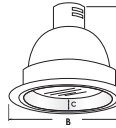

A = 7-7/8"
B = 8-3/8"
C = 1"

7119 - _____
Baffle with Tempered Clear Plastic



TRIM FINISH:
 • W-WH
 • P-WH



A = 7-7/8"
B = 8-3/8"
C = 1"

7109 - _____
Deco Glass Reflector

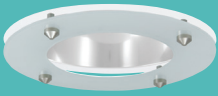

REFLECTOR FINISH:
CL, WT, MB, SHZ, W

RING FINISH:
WH, SCH, SHZ

GLASS FINISH:
BLUE, RED, GREEN, FROST

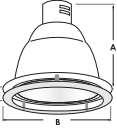

A = 7-7/8"
B = 8-3/8"
C = 1-1/4"

7110 - _____
Double Ring Glass

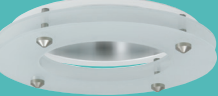

REFLECTOR FINISH:
CL, WT, MB, SHZ, W

RING FINISH:
WH, SCH, SHZ

GLASS FINISH:
BLUE, RED, GREEN, FROST

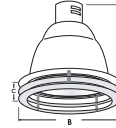

A = 7-7/8"
B = 8-3/8"
C = 1-1/2"

7111 - _____
Triple Ring Glass



REFLECTOR FINISH:
CL, WT, MB, SHZ, W

RING FINISH:
WH, SCH, SHZ

GLASS FINISH:
BLUE, RED, GREEN, FROST

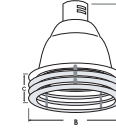

A = 7-7/8"
B = 8-3/8"
C = 2-1/4"

7125 - _____
Center Etched Float Glass



REFLECTOR FINISH:
CL, WT, MB, SHZ, W

RING FINISH:
WH, SCH, SHZ

**Also available in:
7126 - _____
Diffusing Screen Wall Wash*



A = 7-7/8"
B = 8-3/8"
C = 1-1/4"

Due to the changes of constant improvement in lighting technology, all details are subject to change without notice. Consult factory for up to date information.