

FEATURES

INTENDED USE

Ideal in ceiling applications. Perfect for use in kitchen shelvings, cabinets and displays.

DESCRIPTION

- Die-cast aluminum body
- May be mounted recessed or surface (mounting ring supplied)
- Includes 12" wire leads and connector
- Ceiling opening is 2-1/8"

LAMP

- (1) 20W 12V JC Lamp (included)

WARRANTY

Three-year total customer satisfaction warranty

AVAILABLE FINISH

- SN** Satin Nickel
- PB** Polish Brass
- WH** White
- BK** Black
- CH** Chrome
- CP** Copper



DIMENSION

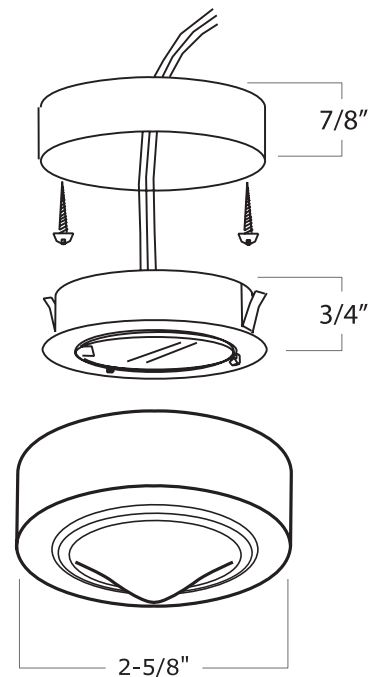

HU-08 - _____ - _____
COLOR QTY

NOTE:

SPECIFIED BY:

TYPE:

JOB NAME: