

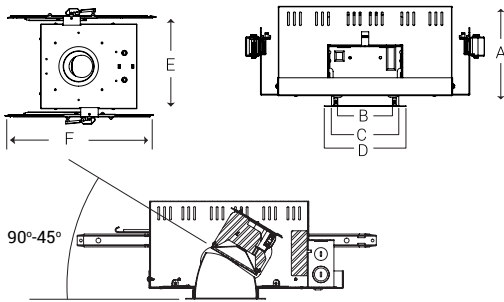

REFLECTOR/  
FLANGE COLORS



A: Height = 5-7/8"  
B: Trim Aperture = 4-1/8"  
C: Cut-Out = 4-3/8"  
D: Trim Outside Dia = 5-3/8"  
E: Width = 13-1/8"  
F: Length = 13-1/8"

NOMINAL LUMENS	DELIVERED LUMENS	WATTAGE
1500	1699	20W
1200	1341	16W
900	995	12W

Based on 4000K, 90+CRI with semi-specular chrome reflector.  
Actual wattage may vary +/-5%

**FEATURES**

A highly sustainable and ultra-efficient architectural LED downlight that provides even, glare-free illumination. Available in a range of finishes, distributions, and lumen packages, it is ideally suited for use in corporate office space, hospitality, healthcare, commercial, academic, churches and retail.

**OPTICS AND REFLECTOR**

The reflector has a 45° visual cutoff, and is shipped standard with a Solite lens in a smooth frosted finish. Spun from 0.05" thick aluminum, with a 1-step anodized finish, and available in different colors or custom RAL finishes. Reflector flange options include self-flanged and white painted flange. Various distribution options are available, and all optics are field changeable.

LUMENS	900, 1200, 1500
CCT & DYNAMIC PLATFORMS	22K, 27K, 30K, 35K, 40K, 50K, Tunable White, Dims to Warm, RGB + White
CRI	90+ Standard, 98+ Optional
COLOR QUALITY	2 Step MacAdam Ellipse
DISTRIBUTIONS	WD (Wide Distribution), MD (Medium Distribution) and ND (Narrow Distribution)
TRIM OPTIONS	Adjustable, Wall Wash
REFLECTOR COLORS	CL (Semi-Specular Chrome), MB (Black), SHZ (Low Iridescent Satin Haze), WH (White)
FLANGE COLORS	Self-Flanged WH (White), SCH (Semi-Specular Chrome), SHZ (Low Iridescent Satin Haze), BK (Black)
DIMMING	0-10V Flicker Free 1% Dimming Standard (DIM10), LUTH, LUTFTB, LUT2W, ELDO10.1, ELDDMX.1, ELDDALI.1, DIMTR
EMERGENCY	10W - Up to 1000L Output (Bodine BSL310) 20W - Up to 2000L Output (Bodine BSL20)
LIFETIME	L70 at 102,000 Hours
PHOTOMETRIC TESTS	In Accordance with IES LM79-08, LM80 and TM-30, TM-21

\*3000 Lumens is not ENERGY STAR certified

\* Only Available on 85+ CRI

WD: Wide  
Candlepower Distribution Curve

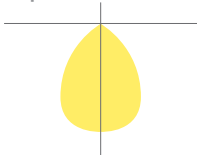

MD: Medium  
Candlepower Distribution Curve

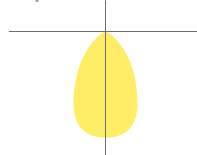

ND: Narrow  
Candlepower Distribution Curve

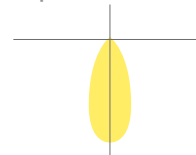

Reference IES files for additional distribution curve information.



**THERMAL MANAGEMENT SYSTEM**

Passive cooling Diecast Aluminum Heat Sink, LED light engine and driver are replaceable, upgradeable, and can be accessed from below the ceiling. The consistency in the quality of light is delivered with precision performance by the use of a unique locking mechanism that aligns the reflector with the light engine.

**MOUNTING FRAME & BRACKETS**

Has full adjustable aiming capability, allowing the double gimbal mechanism to rotate 360°, pivot 90°, and lock into place at any desired position.

**DRIVER ELECTRICAL INFORMATION**

The LED driver is rated for 50 to 60Hz at 120V/277V, also available in 347V input, produces less than 20%THD, has a power factor between 90% and 100%, and is thermally protected for additional safety. Junction box and Driver can be accessed from below the ceiling and above the ceiling. Junction Box is Listed for through branch circuit wiring.

**DIMMING & DRIVER INFORMATION**

**DIM10** - 0-10V dimming on either MVOLT 120, 277 or 347V. Dimmable down to 1% of initial lumens, standard.

**DIMTR** - Triac & Electronic low voltage dimming. Available in 120V, and up to 3000 lumens only.

**LUT2W** - Lutron LTEA2W Hi-Lume 1%. 2-wire LED Driver Forward Phase Control, 1% dimming in 120V only.

**LUTH** - Lutron LDE1 Hi-Lume Eco System. 1% dimming with Soft in Fade to Black dimming technology.

**LUTFB** - Lutron PEQ0 Hi-Lume Premier Eco System. 0.1% dimming with Soft in Fade to Black dimming technology. Available on all luminaires up to 20 watts.

**ELDO10.1** - EldoLED SoloDrive 0-10V. Dimming down to 0.1%.

**DALI** - DALI DT6, DT8 dimming down to 1%.

**ELDODMX** - EldoLED PowerDrive dimming down to 0.1%.

Please see EldoLED website for wiring diagrams and a list of compatible DMX and DALI control systems.

**WARRANTY**

Five-year warranty for parts and components. (Labor not included)

**LED DYNAMIC PLATFORM OPTIONS**

 Tunable White with Smart White Technology utilizing the Lumenetix Platform allows you to color tune the luminaire via various controls. Create the perfect environment for the desired use of the space, while maintaining a CRI of 90+ across the tunable range of 8000 to 1650K. (Click here for more details)

 Dims to Warm with Smart Dimming Technology. At 100% full brightness the luminaire is at 3000K. When dimmed to 1%, the light transitions to 1800K, creating a warm ambiance within the space. (Click here for more details)

 RGB+White with Smart Hue Technology provides full color mixing of RGB and white colors. Utilizing the Lumenetix Platform allows you to choose from unlimited RGB color options, via various controls. Ideal for Circadian Rhythm applications or to create the perfect human centric environment. (Click here for more details)

**LISTINGS**

c-UL-us - Listed for Feed Through Wiring.

U.S Patent No. - D685,118S

Energy Star and California Title 24 compliant

Optional Black color trim is not ENERGYSTAR certified and won't meet the requirement.

Example: HH4ADJ-IC-LED-1500L-DIM10-MVOLT-MD-40K-85-HH4-4501-CL-WH

SERIES	LUMENS	DRIVER	VOLTAGE	CCT	EMERGENCY	TRIM TYPE	REFLECTOR/FLANGE COLORS
HH4ADJ-IC-LED	<input type="checkbox"/> 900L	<input type="checkbox"/> DIM10	<input type="checkbox"/> 120	<input type="checkbox"/> 22K	<input type="checkbox"/> EMG-LED-10W	<input type="checkbox"/> HH4ADJ-4555	<input type="checkbox"/> CL-WH <input type="checkbox"/> CL-SCH <input type="checkbox"/> SHZ-WH <input type="checkbox"/> SHZ-SHZ <input type="checkbox"/> WT-WH <input type="checkbox"/> WH-WH <input type="checkbox"/> MB-WH* <input type="checkbox"/> CL-BK <input type="checkbox"/> MB-BK*
	<input type="checkbox"/> 1200L	<input type="checkbox"/> DIMTR <sup>1</sup>	<input type="checkbox"/> 277	<input type="checkbox"/> 27K	<input type="checkbox"/> EMG-LED-20W		
	<input type="checkbox"/> 1500L	<input type="checkbox"/> LUTH <sup>2</sup>	<input type="checkbox"/> MVOLT	<input type="checkbox"/> 30K	Typical lumen output of the luminaire is up to 1000L with EMG-LED-10W option & 2000L with EMG-LED-20W option in emergency mode. Contact the factory for details. Remote mounted installation		
	<input type="checkbox"/> LUT2W <sup>1</sup>	<input type="checkbox"/> 347	<input type="checkbox"/> 35K				
	<input type="checkbox"/> LUTFB <sup>6</sup>	(DIM10 only)	<input type="checkbox"/> 40K				
	<input type="checkbox"/> ELDO10-.1 <sup>2</sup>		<input type="checkbox"/> 50K <sup>3</sup>				
	<input type="checkbox"/> ELDODALI-.1 <sup>2</sup>						
	<input type="checkbox"/> ELDODMX-.1 <sup>2</sup>						
			<b>OPTICS</b>	<b>CRI</b>			
			<input type="checkbox"/> WD	<input type="checkbox"/> 90+			
		<input type="checkbox"/> MD	<input type="checkbox"/> 98+ <sup>4</sup>				
		<input type="checkbox"/> ND					

<sup>1</sup> DIMTR and LUT2W are available in 120V only

<sup>2</sup> LUTH, ELDO10-.1, ELDODALI-.1, and ELDODMX-.1 are available in 120V and 277V

<sup>3</sup> 50K series are available with 85+ CRI only

<sup>4</sup> 98+ CRI is available in 27K, 30K and 40K only

<sup>5</sup> 3000 Lumens is not energy Star certified

<sup>6</sup> LUTFB Available for luminaires up to 1500L

\* Only Available on 85+ CRI

-Reference last page for Control Options

1- Luminaire will be shipped with Powerpacks pre-installed, ready to be integrated to designated control systems

2- Luminaire will be shipped with Sensors installed on the luminaire, allowing for individual luminaire control. Luminaires will be ready to be integrated with designated control systems

3- Luminaire will be shipped with Sensors to be remotely installed on the ceiling. Luminaires will be ready to be integrated with designated control systems

BRAND	EASYFIT by EnOcean	LUTRON	enlighted	LEVITON®	OSRAM	PHILIPS EasySense	legrand®
CONTROL UNIT	<input type="checkbox"/> LEDRU LED Relay Zone Controller 0-10V <sup>1</sup>  <input type="checkbox"/> LEDDU LED Zone Controller 0-10V <sup>1</sup>	<input type="checkbox"/> FCJS-010 Lutron Vive 0-10V Individual Pow Pak (Luminaire is shipped Vive Enabled) <sup>14</sup>  <input type="checkbox"/> FCJS-ECO Lutron Vive Eco-system Pow Pak (Luminaire is shipped Vive Enabled) <sup>14</sup>	<input type="checkbox"/> CU-4E-FMH Fixture Mount Control Unit <sup>15</sup>	<input type="checkbox"/> ZL027 –NOW Intellect Power Control Module <sup>16</sup>  <input type="checkbox"/> ZL027 –NOW Intellect Power Control Module <sup>16</sup>	<input type="checkbox"/> EN-WCM2-ZB-DR Wireless Control Module <sup>17</sup>  <input type="checkbox"/> EN- ALC-ZB-BK-DR Wireless Area Lighting Control Module <sup>17</sup>  <input type="checkbox"/> ZBHA-CLM-DIM-ENC Connected Lighting Module DIM <sup>17</sup>	<input type="checkbox"/> SBR -BS Xitanium SR Bridge <sup>18</sup>	<input type="checkbox"/> LMFC-011 ON/OFF/0-10V dimming fixture controller <sup>19</sup>
INTEGRAT SENSOR	N/A	N/A	N/A	N/A	N/A	N/A	N/A
*WIRELESS OCCUPANCY SENSOR	<input type="checkbox"/> EOSCU-W-E0 Occupancy Sensor - Ceiling Mounted (Must be specified with LEDRU or LEDDU control unit) <sup>3</sup>	N/A	N/A	N/A	N/A	N/A	<input type="checkbox"/> LMDC-100 Dual technology PIR Ceiling Mount Occupancy Sensor <sup>3</sup>
*WIRELESS DAYLIGHT SENSOR	<input type="checkbox"/> ELLSU-W-E0 Light Level Sensor - Ceiling Mounted (Must be specified with LEDRU or LEDDU control unit) <sup>3</sup>	N/A	N/A	N/A	N/A	N/A	<input type="checkbox"/> LMLS-400 Single zone switching and dimming digital photosensor <sup>3</sup>
*WIRELESS OCCUPANCY & DAYLIGHT SENSOR	N/A	N/A	<input type="checkbox"/> SU-5E-IoT IoT Node Micro Sensor <sup>3</sup> <input type="checkbox"/> SU-5E-CL Connected Lighting Micro Sensor <sup>3</sup> <input type="checkbox"/> SU-5E-IL Independent Lighting / Enlighted One Micro Sensor <sup>3</sup> <input type="checkbox"/> SU-5S-H-(IoT/CL/IL) Surface Mount Sensor <sup>3</sup>  (Must be specified with CU- 4E-FMH Control Unit)	<input type="checkbox"/> ZL00J -TOW Intellect Intelligent Fixture Control System <sup>3</sup>  (Must be specified with ZL027 –NOW Control Unit)	<input type="checkbox"/> EN-CLM-PIR-DD-ZB SensiLUM™ Wireless Integrated Sensor <input type="checkbox"/> EN-SCPPH-1500-ZB Wireless Passive Infrared Occupancy and Photo Sensors <sup>3</sup>  (Must be specified with EN-WCM2-ZB-DR or EN- ALC-ZB-BK-DR Control Unit)	<input type="checkbox"/> SNS200- CMP SNS200 for grouping <sup>3</sup>	N/A
ACCESSORIES	N/A	N/A	<input type="checkbox"/> TMC-SU-5E Tile Mount Carrier <input type="checkbox"/> CBL-5E-CU4-30N 30 inch Sensor Cable for CU-4 and IoT Ready™ drivers <input type="checkbox"/> CBL-5E-CU4-7F 7 foot Sensor Cable for CU-4 and IoT Ready™ drivers	N/A	N/A	N/A	N/A
NOTES	N/A	4- Luminaire will be compatible with Lutron LRF2-OCR2B-P-WH Ceiling mount 360° occupancy/vacancy sensor & LRF2-DCRB-WH Ceiling-mount daylight sensor. Sensors must be ordered through Lutron.	5- Luminaire will be compatible with ENLIGHTED SU-5E-IoT, SU-5E-CL, SU-5E-IL, SU-5S-H, Sensors.	6-Luminaire will be compatible with Leviton Intellect App & Keypad Room Controller	7-Luminaire will be compatible with EN-SCPPH-1500-ZB Wireless Passive Infrared Occupancy and Photo Sensors	8-Luminaire will be compatible with Philips field and wireless switch.	9-Luminaire will be compatible with DLM Room control system LMPB-100. DLM control system must be orderd through Legrand.