



GROOVE BLADE 48V TRACK SYSTEM

The Groove Blade 48V Track System combines minimalism and versatility, offering a streamlined solution for modern lighting needs. Featuring an ultra-slim 7mm-wide track, the Groove Blade system seamlessly integrates into any design. The Groove Blade track utilizes a simple insertion mechanism for mounting fixtures, ensuring effortless installation and interchangeability while maintaining a clean aesthetic.

Available in Trimless Recessed, Ceiling Mount, Suspended Mount, Suspended Mount with Direct and Indirect Illumination, and Wall Mount options, the Groove Blade system adapts to diverse architectural applications. Its mounting options are compatible with surfaces such as wood and drywall ceilings, allowing for seamless integration into walls and ceilings.

The system includes a variety of connectors, such as flat, inside and outside "L" corners, and flexible round curved corners, enabling custom geometric designs and transitions across different planes. Flexible power connectors further enhance design freedom, ensuring smooth connectivity across complex layouts.

Fixtures are fully replaceable and interchangeable, providing the flexibility to update designs as needed. The Groove Blade supports a wide range of mounting options and luminaire types, making it ideal for accent, task, and general illumination in applications such as galleries, museums, hospitality spaces, retail spaces, corporate offices, and residential interiors.

Designed for modern aesthetics and adaptability, the Groove Blade 48V Track System is the perfect choice for those who seek precision and innovation in lighting design.

CONSTRUCTION

All track heads are engineered to have an extremely long lifespan and service period by using coolLED's Advanced Thermodynamic Design, which includes an extruded aluminum body, a hidden diecast heat sink, and a thermal management system.

DRIVERS

The Groove Blade System is powered by constant voltage drivers with a rating of 50/60Hz at a 120/277V input and a 48V output. They produce less than 20% THD, have a 90% power factor, and are thermally protected for additional safety. Driver wattages range from 75W to 450W and can power up to 65' of track. Groove drivers can be installed internally within the track or remotely mounted, and are available in 0-10V 1% Dimming, Dali Dimming, or 120V On/ Off Non-Dimming Driver. Please see Groove track system spec sheets for a complete list of drivers and capabilities.

LED MODULE PERFORMANCE

The Groove Blade System's luminaires are equipped with 2-step McAdam Eclipse LEDs, which provide consistent color across all fixtures, and 90+CRI. The LEDs are available in a variety of kelvin temperature options.

CEILING MOUNT TRACK OPTIONS

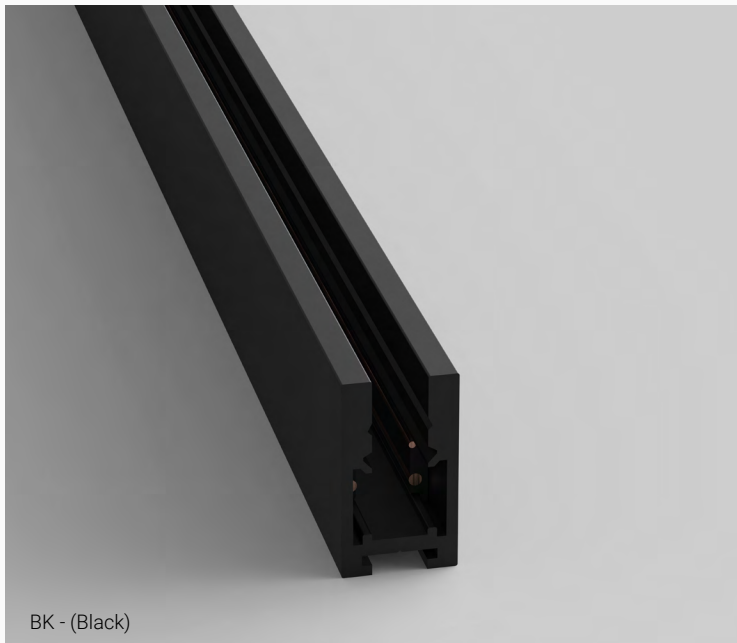

FINISH

Luminaires are available in a powder-coated black or white post-paint finish. They may also be issued in custom RAL colors upon request. Consult the factory to find out which custom colors can be accommodated.

DIMMING INFORMATION

DIM10 - 0-10V dimming on either MVOLT 120, 277. Dimmable down to 1% of initial lumens, standard. Available in 75W, 100W, 150W., 240W.
 DIMTR - Electronic low voltage dimming. Available in 120V.
 DALI - DALI DT6 dimming down to 1% Available in 75W, 100W, 150W, 240W.
 EldoLED PowerDrive dimming down to 0.1%. Please see the EldoLED website for wiring diagrams and a full list of compatible DMX and DALI control systems.

WARRANTY

Five-year warranty for parts and components.

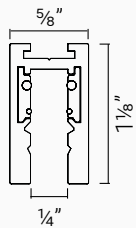
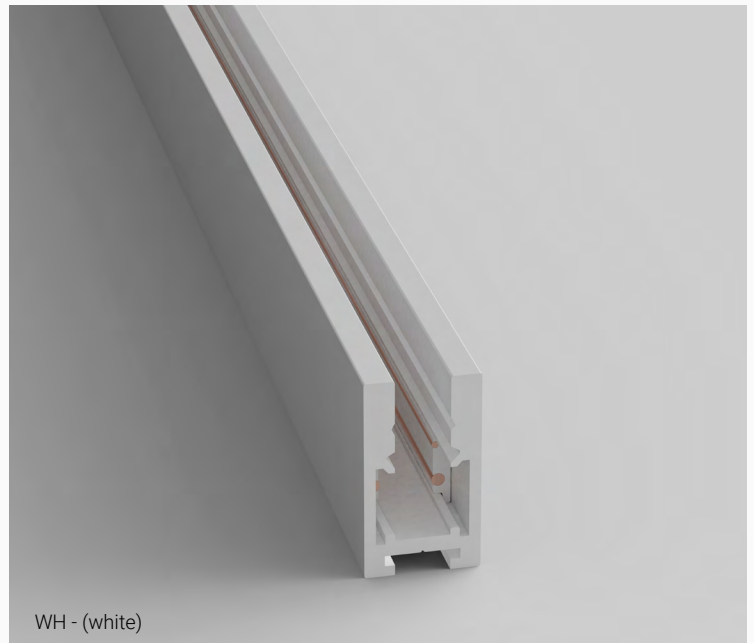

GB-CM-SM-2 2ft

GB-CM-SM-4 4ft

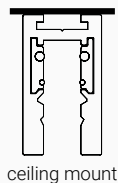

GB-CM-SM-8 8ft

TRACK CORNERS

● BK - (black) ○ WH - (white)

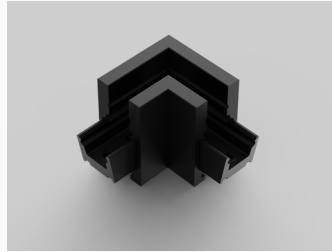
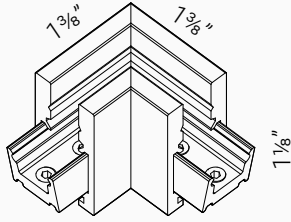

GB-CM-SM-ACC-2 | L-Shaped Flat Corner Joining Bracket | BK / WH

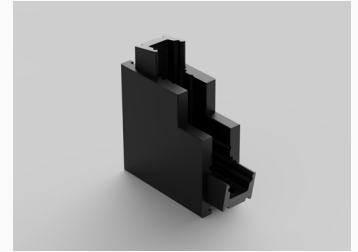
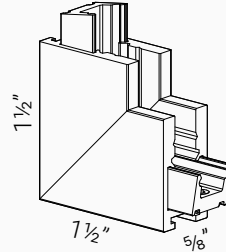

GB-CM-SM-ACC-3 | L-Shaped Inside Corner Joining Bracket | BK / WH

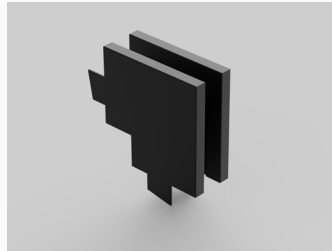
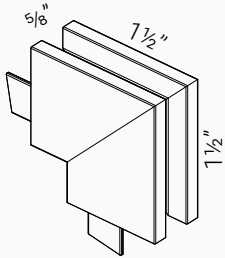

GB-CM-SM-ACC-4 | L-Shaped Outside Corner Joining Bracket | BK / WH

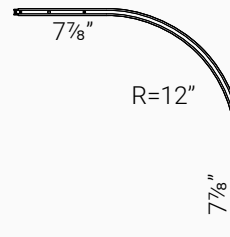

GB-CM-SM-R-1-90D | Round Corner (R=1ft) | BK / WH

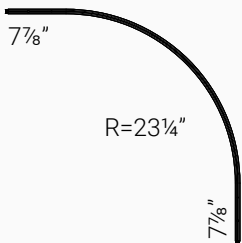

GB-CM-SM-2-90D | Round Corner (R=2ft) | BK / WH

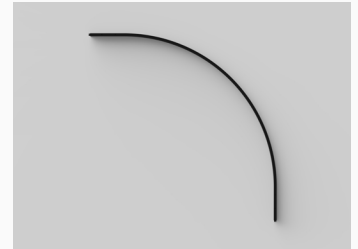
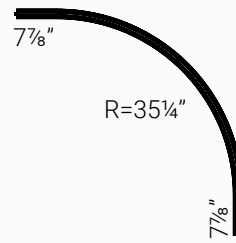

GB-CM-SM-R-3-90D | Round Corner (R=3ft) | BK / WH

ACCESSORIES

● BK - (black) ○ WH - (white)

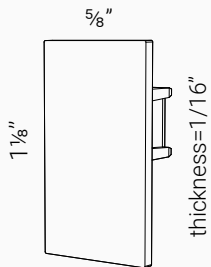

GB-CM-SM-ACC-1 | EndCap | BK / WH

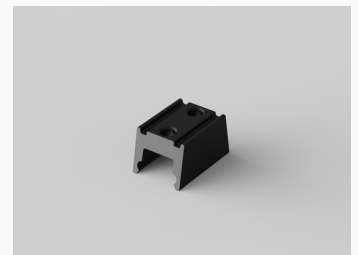
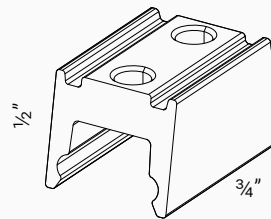

GB-ACC-9 | Track Physical Connector | BK / WH

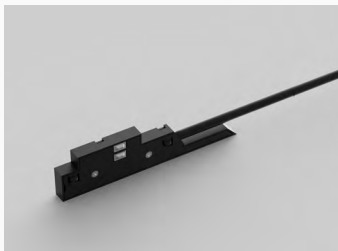
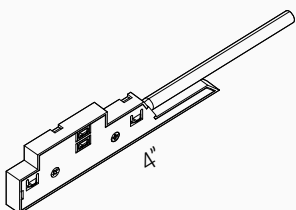

GB-ACC-3 | Live-end with Cable | BK / WH

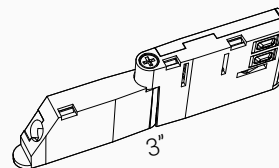

GB-ACC-3-R | Live-end with Cable for Curve | BK / WH

ACCESSORIES

● BK - (black) ○ WH - (white)

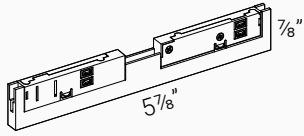

GB-ACC-4 | Power Connector | BK / WH

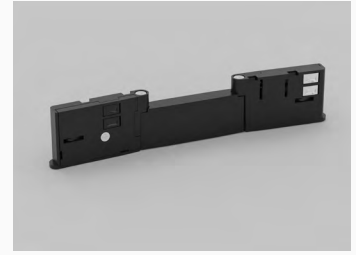
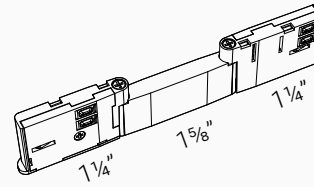

GB-ACC-4-R | Power Connector for Curve | BK / WH

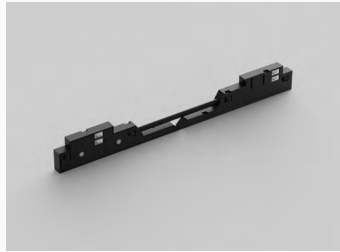
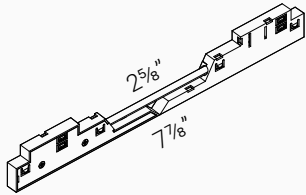

GB-ACC-5 | Flexible Power Connector | BK / WH

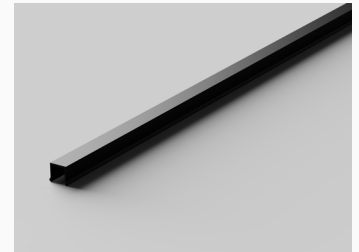
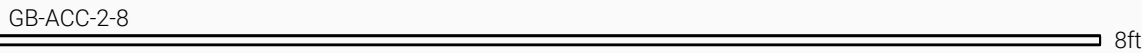
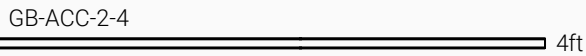
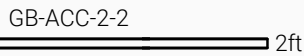

GB-ACC-2 | Track Cover | BK / WH / Acrylic

EXTERNAL DRIVER OPTIONS (WITH BOX):

FG-DR-75W-ON-OFF-48V | FG-DR-75W-DALI-48V | FG-DR-75W-10V-DIM-48V

FG-DR-75W-48V Series Constant Voltage + Constant Current Driver								
Model	Input Voltage	Output Voltage	Wattage (@120VAC)	Wattage (@277VAC)	Rated Current	Efficiency	Frequency	Power Factor (Normal)
FG-DR-75W-48V	120-277VAC	24-48V	60W	76.8W	1.6A	90%	50-60Hz	.9

0-10V & DALI dimming only

FG-DR-100W-ON-OFF-48V | FG-DR-100W-DALI-48V | FG-DR-100W-10V-DIM-48V

FG-DR-100W-48V Series Constant Voltage + Constant Current Driver								
Model	Input Voltage	Output Voltage	Wattage (@120VAC)	Wattage (@277VAC)	Rated Current	Efficiency	Frequency	Power Factor (Normal)
FG-DR-100W-48V	120-277VAC	24-48V	70W	96W	2A	90%	50-60Hz	.9

0-10V & DALI dimming only

EXTERNAL DRIVER OPTIONS (WITH BOX):

When the driver exceeds 96W or the length extends beyond 32 feet, a separate channel is required.

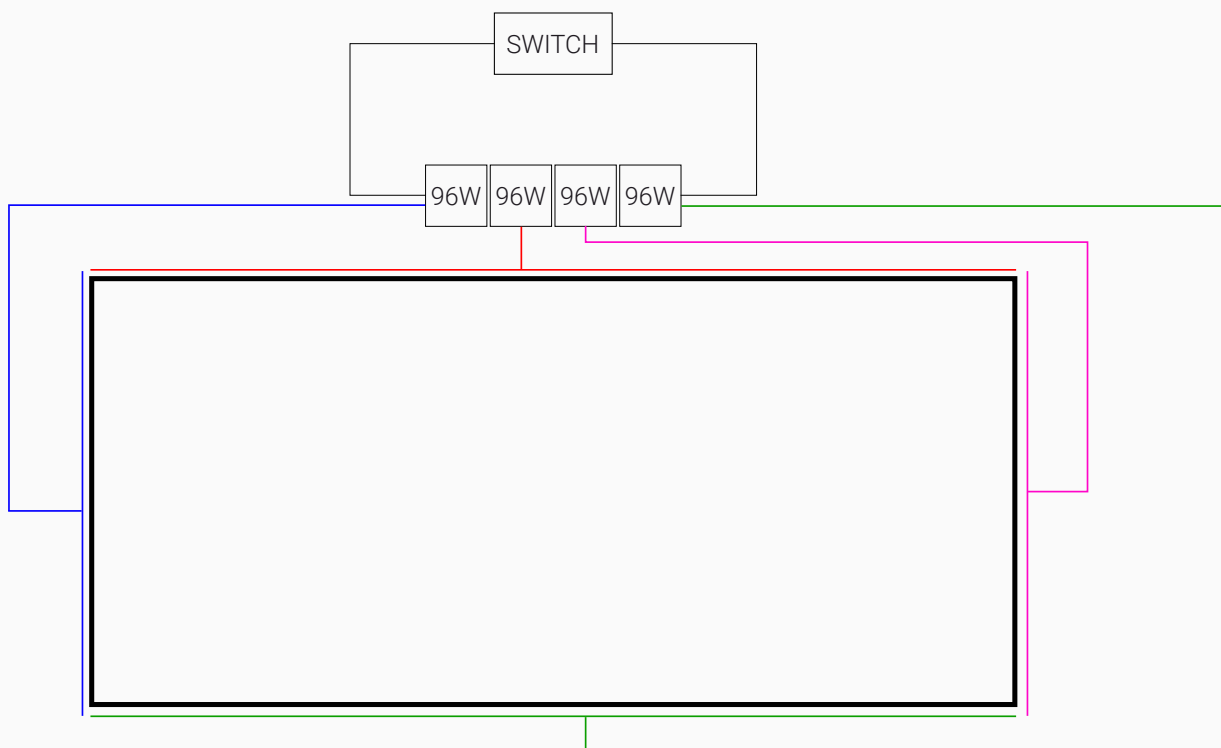

FG-DR-200W-ON-OFF-48V | FG-DR-200W-DALI-48V | FG-DR-200W-10V-DIM-48V

FG-DR-200W-48V Series Constant Voltage + Constant Current Driver								
Model	Input Voltage	Output Voltage	Wattage (@120VAC)	Wattage (@277VAC)	Rated Current	Efficiency	Frequency	Power Factor (Normal)
FG-DR-200W-48V	120-277VAC	24-48V	150W	200W	4.16A	93%	50-60Hz	.9

0-10V & DALI dimming only

FG-DR-320W-ON-OFF-48V | FG-DR-320W-DALI-48V | FG-DR-320W-10V-DIM-48V

FG-DR-320W-48V Series Constant Voltage + Constant Current Driver								
Model	Input Voltage	Output Voltage	Wattage (@120VAC)	Wattage (@277VAC)	Rated Current	Efficiency	Frequency	Power Factor (Normal)
FG-DR-320W-48V	120-277VAC	24-48V	320W	320W	6A	95%	50-60Hz	.9

0-10V & DALI dimming only

FG-DR-480W-ON-OFF-48V | FG-DR-480W-DALI-48V | FG-DR-480W-10V-DIM-48V

FG-DR-480W-48V Series Constant Voltage + Constant Current Driver								
Model	Input Voltage	Output Voltage	Wattage (@120VAC)	Wattage (@277VAC)	Rated Current	Efficiency	Frequency	Power Factor (Normal)
FG-DR-480W-48V	120-277VAC	24-48V	480W	480W	10A	94%	50-60Hz	.9

0-10V & DALI dimming only

DRIVER: FG-DR-75W-48V

Unit: Inches

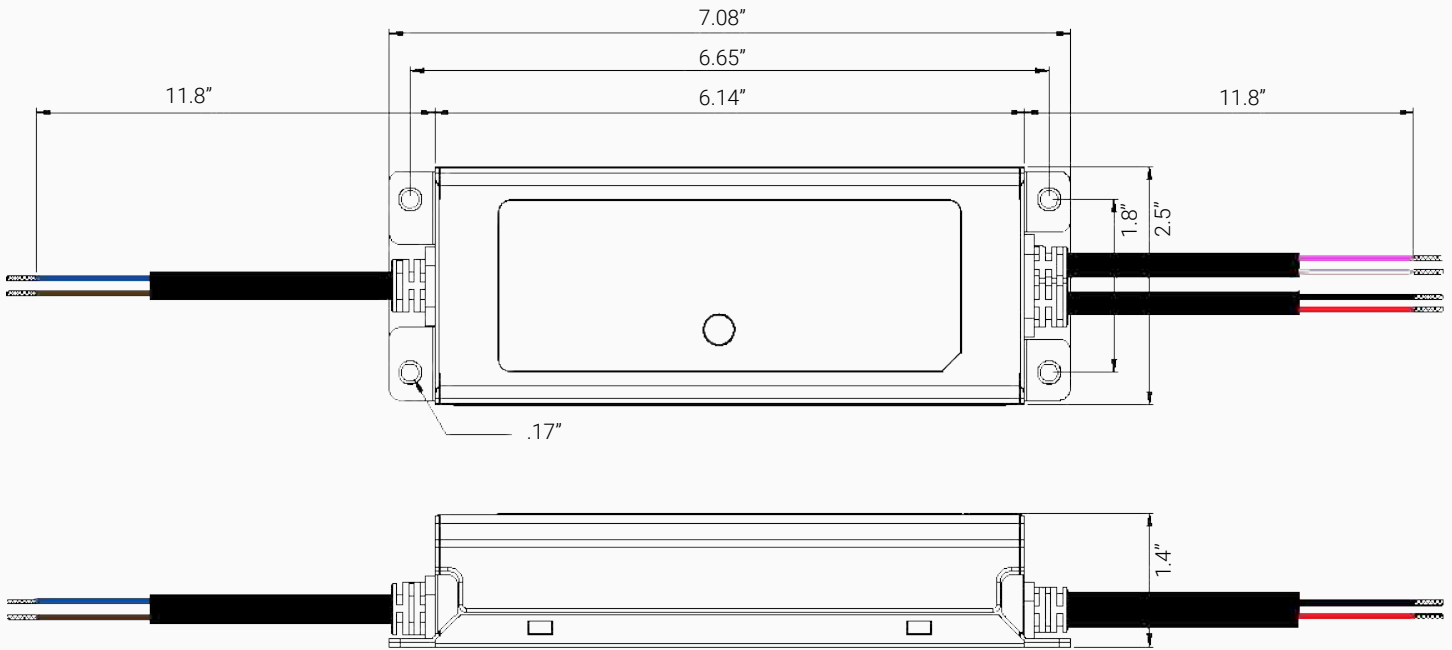

DRIVER: FG-DR-100W-48V

Unit: Inches

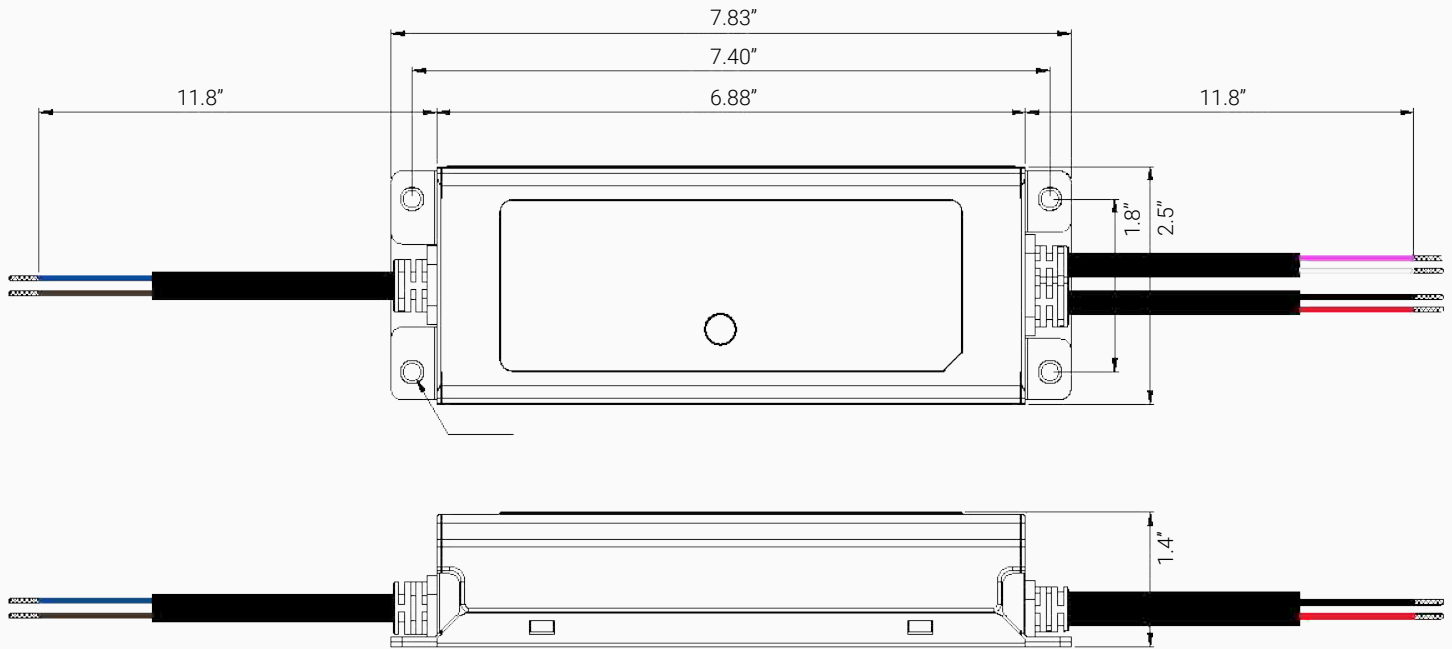

DRIVER: FG-DR-150W-48V

Unit: Inches

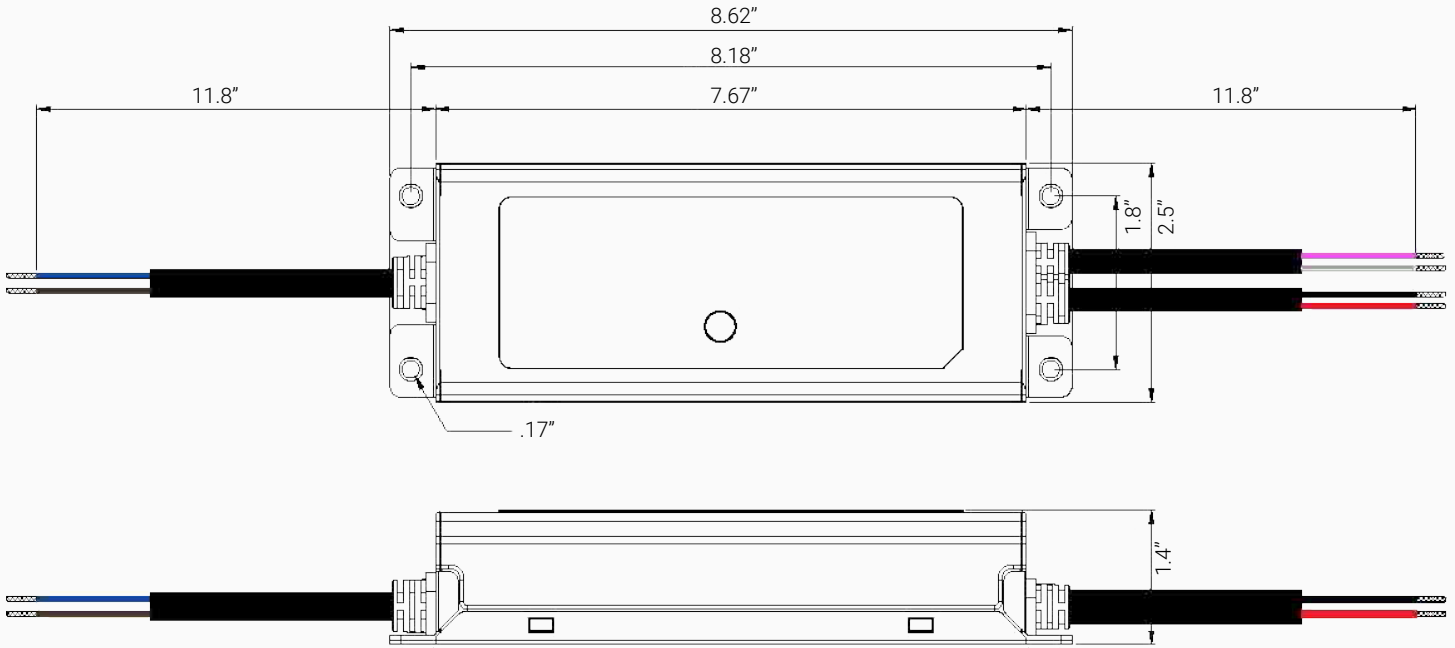

DRIVER: FG-DR-200W-48V

Unit: Inches

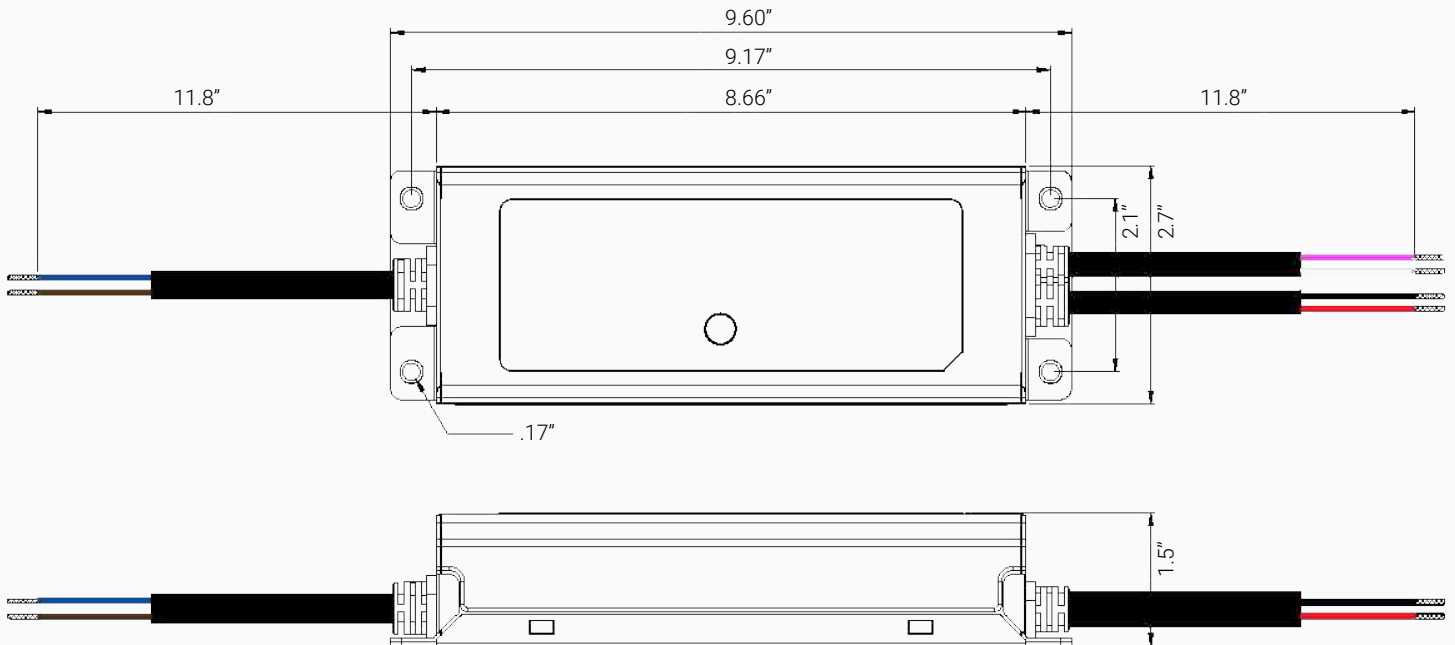

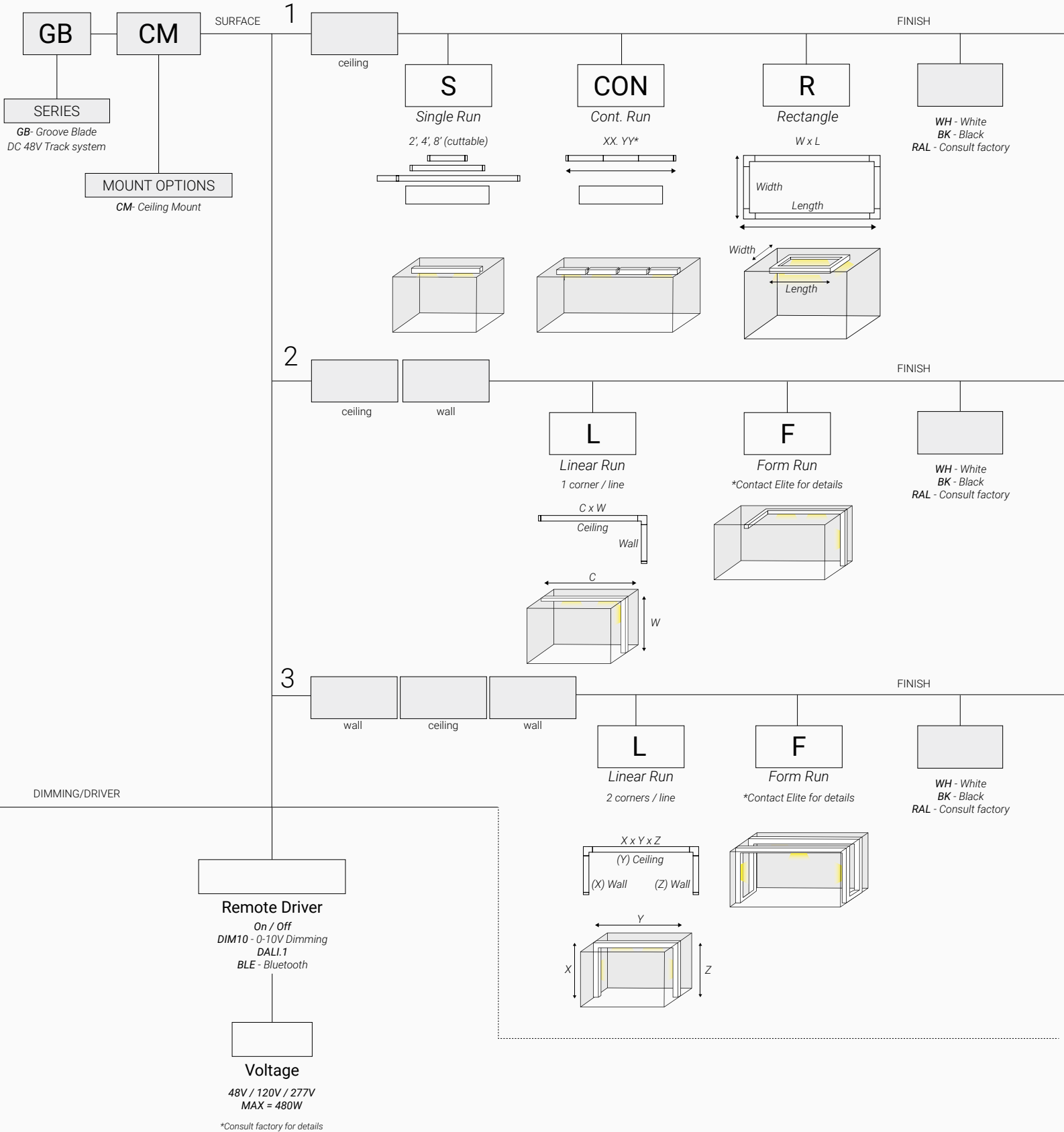

GROOVE BLADE LUMINAIRE OPTIONS

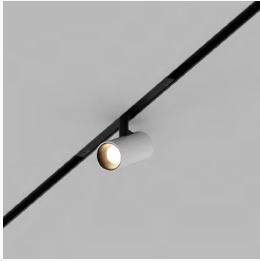

GB-T2-1
Cylinder
1 7/8" x 7/8", 2W, 250 lm



GB-T2-2
Cylinder
2 1/8" x 1 1/8", 2W, 250 lm



GB-T2-3
Cylinder
2 1/2" x 1 1/4", 6W, 900 lm



GB-T2-4
Cylinder
3 1/2" x 2", 13W, 1300 lm



GB-T2-5
Cylinder
4 1/4" x 2 1/4", 18W, 2650 lm



GB-T3-1
Dual Cylinder
1 7/8" x 7/8", 2.1W x2, 500 lm



GB-T3-2
Dual Cylinder
2 1/8" x 1 1/8", 4.5W x2, 1400 lm



GB-T3-3
Dual Cylinder
2 1/2" x 1 1/4", 7W x2, 1800 lm



GB-T3-4
Dual Cylinder
3 1/2" x 2", 13W x2, 3100 lm



GB-T5-1
Flat Round
1" x 3", 6W, 650 lm



GB-T8-1
Track Globe
1 3/8", 2.1W, 260 lm

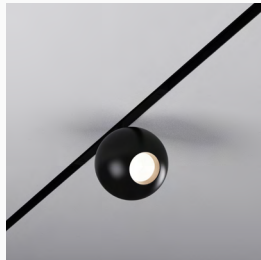

GB-T8-2
Track Globe
2 1/4", 6.3W, 900 lm



GB-T11-1
Globe
4", 4.5W, 330 lm

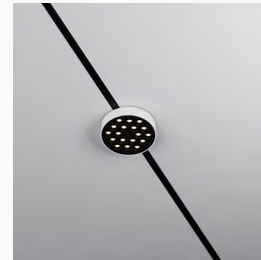

GB-T12-1
Flat Round Downlight
3", 4.5W, 330 lm



GB-T12-2
Flat Round Downlight
4", 9W, 1200 lm



GB-T12-3
Flat Round Downlight
5 1/2", 18W, 2200 lm



GB-TS-1
Flat Round Diffuse
6 1/8", 13W, 1400 lm



GB-T13-1
Round Downlight
3", 4.5W, 330 lm



GB-T13-2
Round Downlight
4", 9W, 1200 lm



GB-T13-3
Round Downlight
5 1/2", 18W, 2200 lm

GROOVE BLADE LUMINAIRE OPTIONS



GB-T14-1
Track Hose Light
2¼" x 7/8", 2W, 255 lm

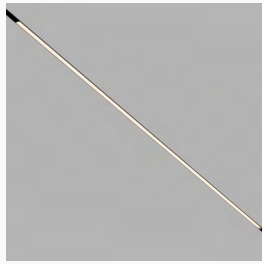

GB-L1R-12
Linear Diffused (12")
12", 4W, 500 lm

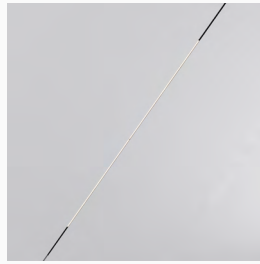

GB-L1R-24
Linear Diffused (24")
24", 8W, 1000 lm



GB-L1R-48
Linear Diffused (48")
48", 16W, 2000 lm



GB-L2R-WW-12
Linear Round Wall Wash
12", 4W, 500 lm



GB-L2R-WW-24
Linear Round Wall Wash
24", 8W, 1000 lm



GB-L2R-WW-48
Linear Round Wall Wash
48", 16W, 2000 lm



GB-L4R-12
Linear Downlight (12")
12", 5W, 310 lm

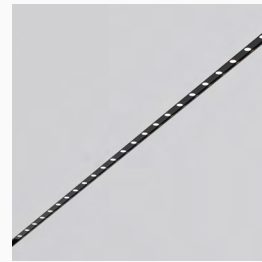

GB-L4R-24
Linear Downlight (24")
24", 9W, 670 lm

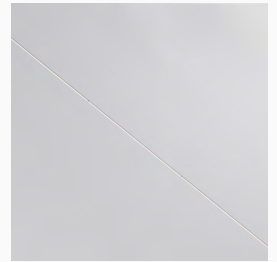

GB-L1R-SI-9
Linear Silicon | 9 ft
9 ft, 7W, 250 lm



GB-P1-1
Pendant
11¾" x 1¼", 7W, 900 lm



GB-P5-1
Pendant Globe
4", 4.5W, 330 lm



GB-P7-1
Pendant Round Diffuse
6¼", 13W x2, 1400 lm



GB-P2-1
Pendant Chandelier
17¾", 11W, 1300 lm