

# G3S

## 3" Miniature Line Voltage GU10 Non-IC Shallow Housing

LAMP WATTAGE: (1) MAXIMUM 120V 50W GU10

Catalog Number:

Project Name:

Type:

Note:

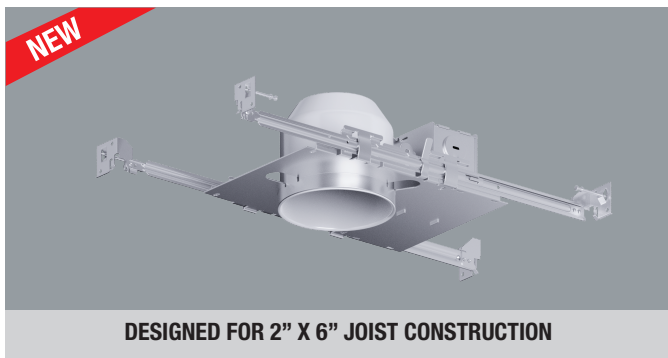

DESIGNED FOR 2" X 6" JOIST CONSTRUCTION

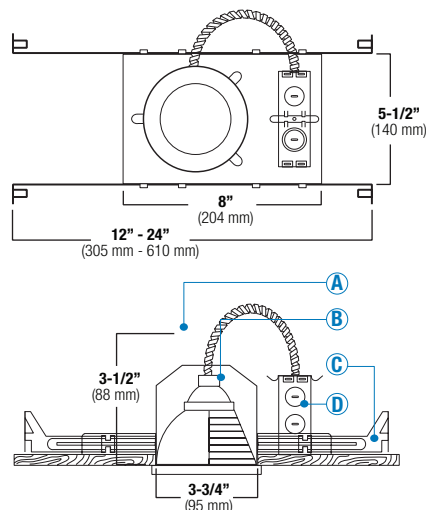

### DESCRIPTION

Small aperture line voltage, thermally protected, specification grade recessed housing. For new construction. Non-insulated ceilings or where insulation can be kept 3" from the housing. Accommodates up to 50W GU10 lamps. Furnished with preinstalled adjustable bar hangers. Junction box is provided with four 1/2" KOs, one 3/4" KO and four Romex knockouts with strain relief.

### SPECIFICATION

**A. HOUSING** - High temperature painted 22 gauge deep drawn single piece housing. Adjusts vertically in plaster frame to accommodate 1/2" to 1-3/8" ceiling. Accommodates lamps up to 50W depending on trim used.

**B. SOCKET** - GU10 floating socket allows for lamp to snap into trim and provide secure lamp retention.

**C. BAR HANGERS** - Preinstalled bar hangers allow housing to be positioned and locked at any point within a 24" joist span and can be shortened for 12" joists. They contain a double-headed real nail for secure attachment into the joist. Bar hanger nails are installed on a 20° downward angle for better contact, and the 90° pivoting mounting plate makes installation fast and accurate. Bar hangers can fit onto T-Bar spline with additional slots and holes for special mounting methods if necessary.

**D. JUNCTION BOX** - listed for through-branch circuit wiring and has four 1/2" KOs, one 3/4" KO and four Romex knockouts with true pry-out slots and strain clamps.

120V



GU10 SOCKET

### FEATURES

- Thermally Protected Non-IC housing.
- Designed for accent and task lighting applications.
- Wire through junction box.
- Preinstalled adjustable bar hanger.
- Dependable, favorable design and effortless installation.
- 5-1/2" height allows use in 2" x 6" joist construction.
- Special screw on the frame locks bar hangers in place which prevents the housing from any movement once installed.

### OPTIONS

#### 1. AIR-SHUT

- Gasket to prevent air flow from heated or air conditioned spaces.
- Meets all national air flow requirements.



G3 - ITEM SELECTOR: (Please check the boxes below for the option desired)

WATTAGE	VOLTAGE	TRIM TYPE				BAFFLE	REFLECTOR	TRIM RING	MR 16 LENS FILTER	
<input type="checkbox"/> 50W	<input type="checkbox"/> 120	<input type="checkbox"/> B1351 <sup>1</sup>	<input type="checkbox"/> B1372 <sup>2</sup>	<input type="checkbox"/> B1390	<input type="checkbox"/> B1314	<input type="checkbox"/> W	<input type="checkbox"/> CL	<input type="checkbox"/> WH	<input type="checkbox"/> BP8MR16-BL (Blue)	<input type="checkbox"/> BP8MR16-FR (Frosted)
		<input type="checkbox"/> B1353 <sup>1</sup>	<input type="checkbox"/> B1374 <sup>2</sup>	<input type="checkbox"/> B1391	<input type="checkbox"/> B1315	<input type="checkbox"/> P	<input type="checkbox"/> RG	<input type="checkbox"/> BK	<input type="checkbox"/> BP8MR16-GR (Green)	<input type="checkbox"/> BP8MR16-SP (Spread)
		<input type="checkbox"/> B1354 <sup>1</sup>	<input type="checkbox"/> B1375 <sup>2</sup>	<input type="checkbox"/> B1320	<input type="checkbox"/> B1362	<input type="checkbox"/> SN	<input type="checkbox"/> W	<input type="checkbox"/> SN	<input type="checkbox"/> BP8MR16-PI (Pink)	<input type="checkbox"/> BP8MR16-SF (Soft Focus)
		<input type="checkbox"/> B1355 <sup>1</sup>	<input type="checkbox"/> B1376 <sup>2</sup>	<input type="checkbox"/> B1325	<input type="checkbox"/> B1352	<input type="checkbox"/> CP	<input type="checkbox"/> MB	<input type="checkbox"/> CP	<input type="checkbox"/> BP8MR16-PU (Purple)	<input type="checkbox"/> BP8MR16-HC (Honey Comb)
		<input type="checkbox"/> B1356 <sup>1</sup>	<input type="checkbox"/> B1396	<input type="checkbox"/> B1324	<input type="checkbox"/> B1312	<input type="checkbox"/> BZ	<input type="checkbox"/> BZ	<input type="checkbox"/> CH	<input type="checkbox"/> BP8MR16-DL (Day Light)	<input type="checkbox"/> BP8MR16-LI (Linear)
		<input type="checkbox"/> B1357 <sup>1</sup>	<input type="checkbox"/> B1378	<input type="checkbox"/> B1301	<input type="checkbox"/> B1368		<input type="checkbox"/> CP	<input type="checkbox"/> PB	<input type="checkbox"/> BP8MR16-YE (Yellow)	<input type="checkbox"/> BP8MR16-SOL (Solite)
		<input type="checkbox"/> B1358 <sup>1</sup>	<input type="checkbox"/> B1379	<input type="checkbox"/> B1302	<input type="checkbox"/> B1304		<input type="checkbox"/> SN	<input type="checkbox"/> BZ	<input type="checkbox"/> BP8MR16-AM (Amber)	<input type="checkbox"/> BP8MR16-CL (Clear)
		<input type="checkbox"/> B1359 <sup>1</sup>	<input type="checkbox"/> B1383	<input type="checkbox"/> B1316	<input type="checkbox"/> B1377		<input type="checkbox"/> SHZ	<input type="checkbox"/> CH <sup>1</sup>	<input type="checkbox"/> BP8MR16-OR (Orange)	<input type="checkbox"/> BP8MR16-UV (Ultraviolet)
		<input type="checkbox"/> B1360 <sup>1</sup>	<input type="checkbox"/> B1380	<input type="checkbox"/> B1326				<input type="checkbox"/> SS <sup>2</sup>	<input type="checkbox"/> BP8MR16-OR (Orange)	<input type="checkbox"/> BP8MR16-UV (Ultraviolet)
		<input type="checkbox"/> B1370 <sup>2</sup>	<input type="checkbox"/> B1384	<input type="checkbox"/> B1366					<input type="checkbox"/> BP8MR16-RE (Red)	
		<input type="checkbox"/> B1371 <sup>2</sup>	<input type="checkbox"/> B1395	<input type="checkbox"/> B1303						

1 = CH - Chrome finished • 2 = SS - Stainless Steel finished

### Specifications:

G3S

WATT - VOLTAGE - OPTION - TRIM TYPE - BAFFLE - REFLECTOR - TRIM/RING - FILTER (1) - FILTER (2)

BAFFLE	REFLECTOR	TRIM/RING
W White	CL Chrome	WH White
P Black	RG Gold	BK Black
SN Satin Nickel	W White	SN Satin Nickel
CP Copper	MB Black	CP Copper
BZ Bronze	BZ Bronze	CH Chrome
	CP Copper	PB Polish Brass
	SN Satin Nickel	BZ Polish Brass
	SHZ Satin Haze	BZ Bronze

\*For custom baffle, reflector, trim ring, glass color and lens options, please consult factory.

Sample of Catalog Number: G3-50W-B1301-W-WH-BP8MR16-BL



Submittal form is available @ [www.iuseelite.com](http://www.iuseelite.com)  
Tel: 323-888-1973 • Fax: 323-888-1977

Specifications and Dimensions  
subject to change without notice.

REV: ELITE LIGHTING-SPEC-05-24-2011

# 3" Low Voltage Trims

( LAMP WATTAGE: 75W 12V MR16 / 50W 120V GU10 )

















Catalog Number:

Project Name:

Type:

Note:



<p><b>B1351CH</b> RUBY I</p>  <p>O.D.: 3-7/8" FINISH TRIM: CH (CHROME)</p>	<p><b>B1353CH</b> RUBY II</p>  <p>O.D.: 3-7/8" FINISH TRIM: CH (CHROME)</p>	<p><b>B1354CH</b> SAPPHIRE I</p>  <p>O.D.: 3-7/8" FINISH TRIM: CH (CHROME)</p>	<p><b>B1355CH</b> SAPPHIRE II</p>  <p>O.D.: 3-7/8" FINISH TRIM: CH (CHROME)</p>
<p><b>B1356CH</b> EMERALD I</p>  <p>O.D.: 3-7/8" FINISH TRIM: CH (CHROME)</p>	<p><b>B1357CH</b> EMERALD II</p>  <p>O.D.: 3-7/8" FINISH TRIM: CH (CHROME)</p>	<p><b>B1358CH</b> TOPAZ I</p>  <p>O.D.: 3-7/8" FINISH TRIM: CH (CHROME)</p>	<p><b>B1359CH</b> TOPAZ II</p>  <p>O.D.: 3-7/8" FINISH TRIM: CH (CHROME)</p>
<p><b>B1360CH</b> ONYX</p>  <p>O.D.: 3-7/8" FINISH TRIM: CH (CHROME)</p>	<p><b>B1370SS</b> ADJ. STAINLESS STEEL GIMBAL TRIM</p>  <p>O.D.: 3-7/8" FINISH TRIM: SS (STAINLESS STEEL)</p>	<p><b>B1371SS</b> STAINLESS STEEL LENSED TRIM</p>  <p>O.D.: 3-7/8" FINISH TRIM: SS (STAINLESS STEEL)</p> <p>FOR WET LOCATION</p>	<p><b>B1372SS</b> STAINLESS STEEL EYEBALL TRIM</p>  <p>O.D.: 3-7/8" FINISH TRIM: SS (STAINLESS STEEL)</p>
<p><b>B1374SS</b> ADJ. STAINLESS STEEL SQUARE GIMBAL TRIM</p>  <p>O.D.: 3-7/8" FINISH TRIM: SS (STAINLESS STEEL)</p>	<p><b>B1375SS</b> STAINLESS STEEL SQUARE EYEBALL TRIM</p>  <p>O.D.: 3-7/8" FINISH TRIM: SS (STAINLESS STEEL)</p> <p>FOR WET LOCATION</p>	<p><b>B1376SS</b> ADJ. STAINLESS STEEL SQUARE EYEBALL TRIM</p>  <p>O.D.: 3-7/8" FINISH TRIM: SS (STAINLESS STEEL)</p>	<p><b>B1396SN</b> SQUARE BAFFLE W/ SQUARE TRIM RING</p>  <p>TRIM FINISH: WH, BK, SN, CP, CH, PB, BZ</p>

# 3"

# Low Voltage Trims

(LAMP WATTAGE: 75W 12V MR16 / 50W 120V GU10)

Catalog Number:

Project Name:

Type:

Note:



**B1378SN-SN**  
STEPPED BAFFLE (35° TILT)

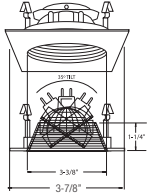

**AVAILABLE COLOR COMBINATIONS:**  
CP-CP, SN-SN, W-WH, P-WH, P-BK, BZ-BZ

**B1379CL-WH**  
REFLECTOR (35° TILT)

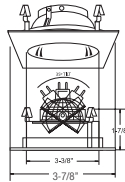

**AVAILABLE COLOR COMBINATIONS:**  
CL-WH, CL-SN, RG-WH, MB-WH, W-WH, MB-BK, RG-PB, SN-SN, CL-CH, CP-CP, CP-WH, SN-WH

**B1383WH**  
SLOT APERTURE (35° TILT)

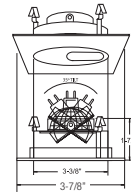
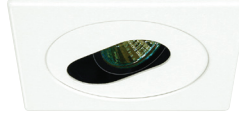

**TRIM FINISH:**  
WH, BK, SN, CP, CH, PB, BZ

**B1384P-WH**  
FULLY ADJUSTABLE W/ BAFFLE



(35° TILT, 359° ROTATION)

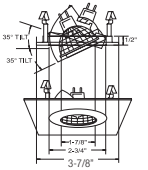

**AVAILABLE COLOR COMBINATIONS:**  
W-WH, P-WH, P-BK, CP-CP, SN-SN, BZ-BZ

**B1380WH**  
FULLY ADJUSTABLE (35° TILT, 359° ROT.)

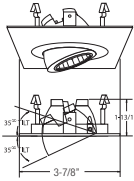

**TRIM FINISH:**  
WH, BK, SN, CP, CH, PB, BZ

**B1391P-WH**  
PINHOLE WITH BAFFLE

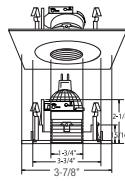
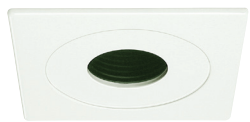

**AVAILABLE COLOR COMBINATIONS:**  
CP-CP, SN-SN, W-WH, P-WH, P-BK, BZ-BZ

**B1390WH-PEACH**  
METROPOLITAN ICE LITE

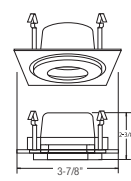

**TRIM FINISH:**  
WH, BK, SN, CP, CH, PB

**GLASS FINISH:**  
BLUE, PEACH, GREEN, CLEAR, AMBER, FROSTED

**B1395CL-SN**  
SEMI-FROSTED SHOWER TRIM

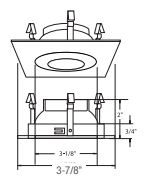

**REFLECTOR FINISH:**  
CL

**RING FINISH:**  
WH, BK, SN, CP, CH, PB, BZ

**B1301CP-CP**  
STEPPED BAFFLE

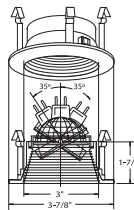

**AVAILABLE COLOR COMBINATIONS:**  
CP-CP, SN-SN, W-WH, P-WH, P-BK, BZ-BZ

**B1302CP-WH**  
REFLECTOR

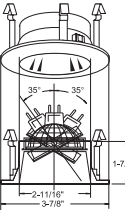

**AVAILABLE COLOR COMBINATIONS:**  
CP-CP, CP-WH, W-WH, RG-WH, SN-SN, SN-WH, MB-WH, CL-WH, MB-BK, RG-PB, CL-CH, CL-SN

**B1316CL-WH**  
REFLECTOR (35° TILT)

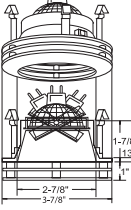
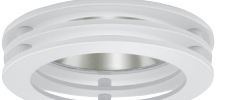

**AVAILABLE COLOR COMBINATIONS:**  
CL-WH, CL-SN, CL-PB

**B1326CL-WH**  
THE ILLUMINATOR II

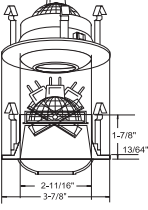

**AVAILABLE COLOR COMBINATIONS:**  
CL-WH, CL-SN, CL-BK, MB-BK

**B1366CL-WH**  
THE ILLUMINATOR

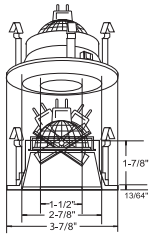

**AVAILABLE COLOR COMBINATIONS:**  
CL-WH, CL-SN, CL-BK, MB-BK

**B1303WH**  
SLOT APERTURE

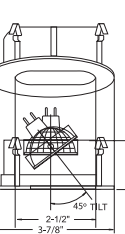
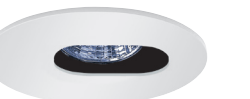

**TRIM FINISH:**  
WH, BK, SN, CP, CH, PB, BZ

**B1314P-WH**  
PINHOLE WITH BAFFLE

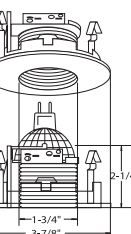

**AVAILABLE COLOR COMBINATIONS:**  
CP-CP, SN-SN, W-WH, P-WH, P-BK, BZ-BZ

**B1315RG-WH**  
PINHOLE WITH REFLECTOR

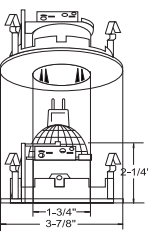

**AVAILABLE COLOR COMBINATIONS:**  
CL-WH, CL-SN, RG-WH, MB-WH, W-WH, CP-CP



Submittal form is available @ [www.iuseelite.com](http://www.iuseelite.com)  
Tel: 323-888-1973 • Fax: 323-888-1977

Specifications and Dimensions subject to change without notice.

REV: MAXLUME-SPEC-05-26-2011

# 3" Low Voltage Trims

( LAMP WATTAGE: 75W 12V MR16 / 50W 120V GU10 )

Catalog Number:

Project Name:

Type:

Note:



**B1362WH**  
SHOWER TRIM W/ FROSTED LENS

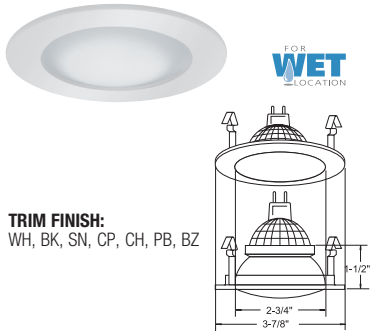

**TRIM FINISH:**  
WH, BK, SN, CP, CH, PB, BZ

**B1352CL-WH**  
SHOWER TRIM WITH REFLECTOR

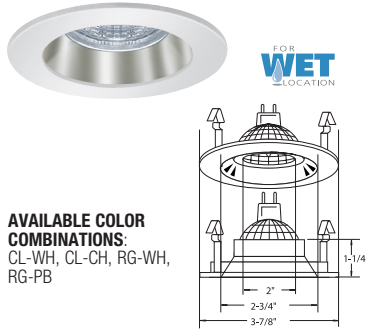

**AVAILABLE COLOR COMBINATIONS:**  
CL-WH, CL-CH, RG-WH, RG-PB

**B1368W-WH**  
FULLY ADJUSTABLE W/ BAFFLE (35° TILT)

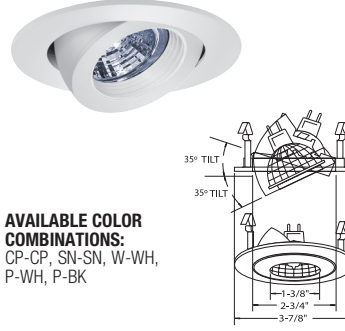

**AVAILABLE COLOR COMBINATIONS:**  
CP-CP, SN-SN, W-WH, P-WH, P-BK

**B1312SN**  
FULLY ADJUSTABLE (35° TILT)

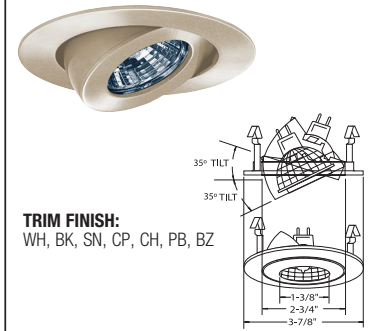

**TRIM FINISH:**  
WH, BK, SN, CP, CH, PB, BZ

**B1304W-WH**  
EYEBALL W/ BAFFLE (47° TILT)

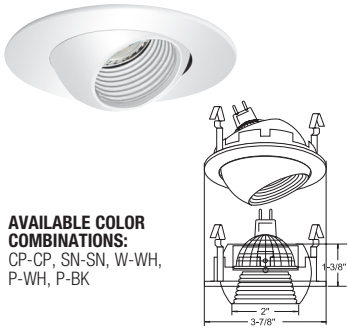

**AVAILABLE COLOR COMBINATIONS:**  
CP-CP, SN-SN, W-WH, P-WH, P-BK

**B1377CL-WH**  
CROSSBLADE REFLECTOR



**AVAILABLE COLOR COMBINATION:**  
CL-WH

**B1320WH-CRYSTAL**  
METROPOLITAN MOON LITE

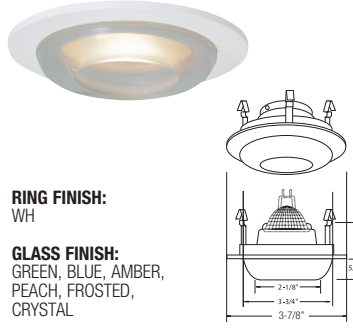

**RING FINISH:**  
WH  
**GLASS FINISH:**  
GREEN, BLUE, AMBER, PEACH, FROSTED, CRYSTAL

**B1325WH-AMBER**  
METROPOLITAN STEP LITE



**RING FINISH:**  
WH  
**GLASS FINISH:**  
GREEN, BLUE, AMBER, PEACH, FROSTED, CRYSTAL

**B1324WH-RED**  
METROPOLITAN HONEY LITE

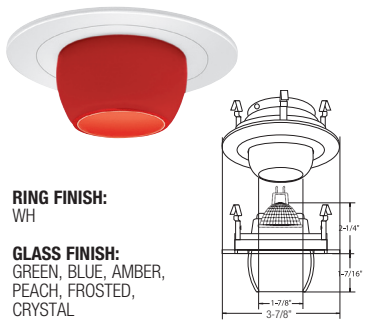

**RING FINISH:**  
WH  
**GLASS FINISH:**  
GREEN, BLUE, AMBER, PEACH, FROSTED, CRYSTAL

BAFFLE	REFLECTOR	TRIM RING
<b>W</b> White	<b>CL</b> Chrome	<b>WH</b> White
<b>P</b> Black	<b>RG</b> Gold	<b>BK</b> Black
<b>SN</b> Satin Nickel	<b>W</b> White	<b>SN</b> Satin Nickel
<b>CP</b> Copper	<b>MB</b> Black	<b>CP</b> Copper
<b>BZ</b> Bronze	<b>CP</b> Copper	<b>CH</b> Chrome
	<b>SN</b> Satin Nickel	<b>PB</b> Polish Brass
		<b>BZ</b> Bronze

\*For custom baffle, reflector, trim ring, glass color and lens options, please consult factory.