

DIMENSIONS

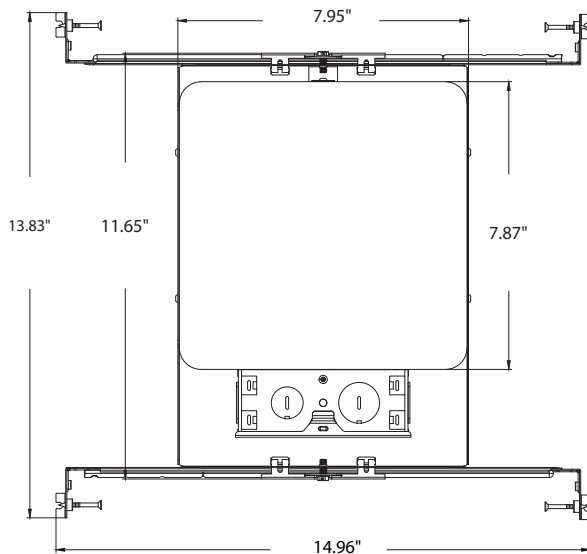
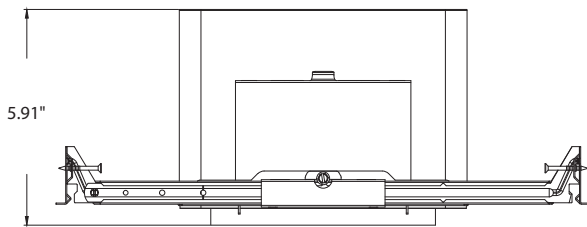

PART NUMBER

FS-LD6IC-AT-DIMTR/DIM10

FEATURES

6" 1-Hour or 2-Hour Fire-rated Recessed IC housing for use with variety of LED series LED Module trims. Our FIRE SHIELD Housing is designed to meet today's One or Two-Hour FireRated IC & Non-IC Codes for high-rise Condominiums, Apartment Buildings, Multi-Family Residences, Hotels, Hospitalities, Assisted Living Homes, Hospitals, Health Care and many more applications.

FIRE PROTECTION PERFORMANCE

- The luminaire ships assembled with the fire protection material already attached in their working positions
- As the fire intensifies, a protection noncombustible fiber off the bottom opening of the housing and stops the fire from passing through the fixture
- The inner assembly reacts strongly to high temperatures (428°F/220°C and above) and swells to a solid dense mass filling the entire luminaire cavity
- Prevents flames and smoke from passing through the light fixture and spreading throughout floor above
- The Fire Shield family of Lighting Luminaires protect the floors above by preventing heat and flames from passing into the ceiling void
- Easier and faster to install than custom-built fireboxes and housings that require hats or additional fire-rated materials
- Fire Shield recessed lighting luminaires are available with a variety of LED modules in different lumen packages, Kelvin temperatures, trim types, and color options. LED modules are available in a 650L and 900L lumen packages and in selectable 27K, 30K, 35K, 40K, and 50K Kelvin temperatures. Available modules include baffle, reflector, downlight, adjustable, wall wash, and shower, in white, black or custom RAL.
- Compatible with both TRIAC and ELV dimming LED retrofit modules. • Conforms to UL263, ASTM STD E119 and ETL 1hr. to 2hrs fire rated.



CONSTRUCTION

Die formed galvanized steel housing with noncombustible fiber insulation , Sound transmission class (STC) and impact insulation class (IIC).Housing provides up to 2 hours of protection in L500, L505, L511, L536, L538, L541, L556, L577,M500, M510, M521 and M543 FloorCeiling construction.

HOUSING

Powdered-coated steel and galvanized steel for maximum heat dissipation and rust protection. Factory assembled with 1 or 2 hour Fire-rated components. Housing adjusts vertically in plaster frame to accommodate 1/2" to 1-3/8" thick ceiling. Housing is IC rated for direct contact with insulation and can be used in IC and Non-IC applications. May be installed in 2" x 8" joist construction.

FINISH

Housing painted red for fire safe identification.

MOUNTING FRAME & BRACKETS

Pre installed bar hangers allow housing to be positioned and locked at any point within a 24" joist span. They can be positioned on either the long or short axis of the housing and can be shortened for 12" joists. They contain a double-headed real nail for secure attachment into the joist. Bar hanger nails are installed on a 20° downward angle for better contact, and the 90° pivoting mounting plate makes installation fast and accurate. junction box Compact galvanized steel junction box with 24in3 internal volume with 5 conduit knock-outs positioned to allow straight conduit runs.

DIMMING & DRIVER INFORMATION

Compatible with both TRIAC and ELV dimming LED retrofit modules. DIM10: 0-10V dimming

Electrical Connections Features non-screw base 120V plug-in connector and it's Compatible with ELITE Lighting retrofit LED trim modules

OPERATING TEMPERATURE

Luminaire must be installed and operated in damp or wet locations depending of the rating of the trim where the ambient temperature ranges from -4°F to 104°F (-20°C to 40°C).

WARRANTY

Five-year warranty for parts and components. (Labor not included)

LISTINGS

Type IC inherently protected, suitable for direct contact to air permeable insulation and cULus 1598

ULus Listed for protected damp locations.

UL263 listed for up to 2 hour fire rated floor/ceiling gypsum assembly per UL Design No.L500, L505, L511, L536, L538, L541, L556, L577, M500, M510,M521 & M543

UL263 listed for up to1 hour fire rated floor/ceiling and roof/ceiling gypsum assembly per L Design No. L500 & P500

ETL certified 1hr. to 2hrs fire rated

cULus Listed for Wet location listed in covered ceilings certified with select trims

AIR-SHUT ASTM E283

Gasket to prevent air flow from heated or air conditioned spaces.

Meets all national air flow requirements.

Suitable for use in clothes closets when installed in accordance with the NEC 410.16 spacing requirements

RoHS compliant

Can be used for State of California Title 24 high efficacy LED compliance under JA8, referenc

COMPATIBLE DIMMERS

DIMMER	BRAND
SCL-153P	Lutron
MSCL-OP153M	Lutron
PD-6WCL	Lutron
DVRP-253P	Lutron
DVCL-253P	Lutron
PD-5NE	Lutron
NTCL-250	Lutron

DIMMER	BRAND
RH703PTUW	Legrand
MRF2-600M-WH	Lutron
MRF2S-6ELV120-WH	Lutron
DSE06-10Z	Leviton
DVELV-303-P-WH	Lutron
MAELV-600-WH	Lutron
VPE06-1LZ	Leviton

COMPATIBLE RETROFIT MODULES

EASY COLOR
SELECTOR

Baffle

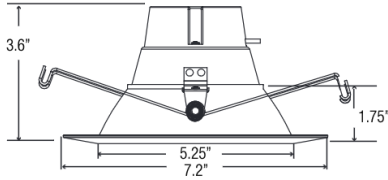

TYPE	LUMEN/DIM/VOLT.	CCT	CRI	FINISH
REL637	950L-DIMTR-120	27K/30K/35K/40K/50K	90+	W-WH - White P-BK - Black



EASY COLOR
SELECTOR

Baffle

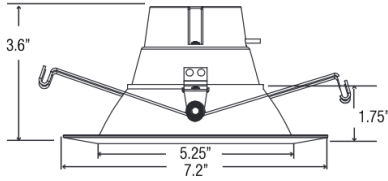

TYPE	LUMEN/DIM/VOLT.	CCT	CRI	FINISH
RL631	950L-DIMTR-120	27K/30K/35K/40K/50K	90+	W-WH - White



EASY COLOR
SELECTOR

Reflector

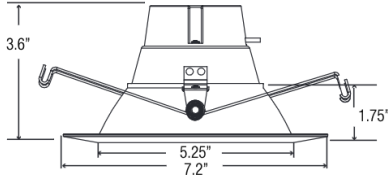

TYPE	LUMEN/DIM/VOLT.	CCT	CRI	FINISH
RL628	950L-DIMTR-120	27K/30K/35K/40K/50K	90+	W-WH - White



Reflector

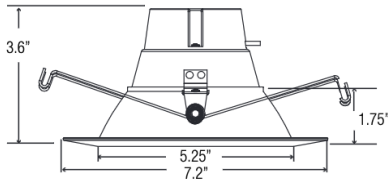

TYPE	LUMEN/DIM/VOLT.	CCT	CRI	FINISH
RL607	950L-DIM10-MVOLT	27K 30K 35K 40K	90+	W- WH - Clear-White

EASY COLOR
SELECTOR

Reflector

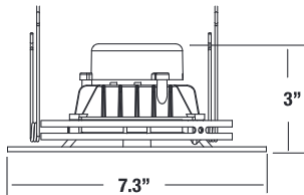

TYPE	LUMEN/DIM/VOLT.	CCT	CRI	FINISH
RL685	950L-DIMTR-120	27K/30K/35K/40K/50K	90+	W-WH - White



EASY COLOR
SELECTOR

Baffle

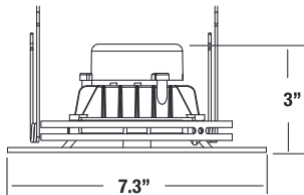

TYPE	LUMEN/DIM/VOLT.	CCT	CRI	FINISH
RL687	950L-DIMTR-120	27K/30K/35K/40K/50K	90+	W-WH - White

