

FS-LD5IC-AT

5" LED Fire Shield IC/Non-IC Housing

1 or 2 Hour Fire Rated Luminaire

Catalog Number:

Project Name:

Type:

Note:

FIRE SHIELD

DESIGNED FOR 2" X 8" JOIST CONSTRUCTION

TO BE USED WITH LED MODULE LIGHTING COMPONENT ONLY

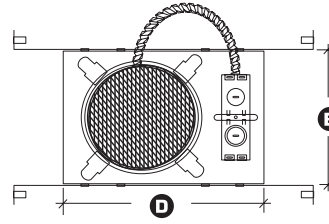
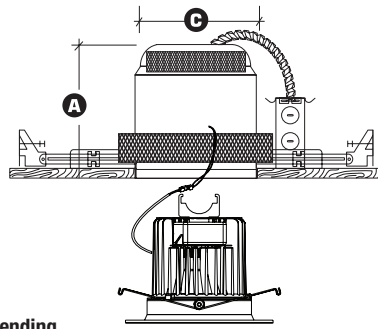
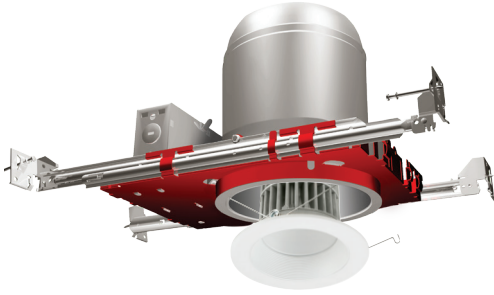

- A** Height = 7-1/2"
- B** Width = 7"
- C** Cut-out = 5-3/4"
- D** Length = 10"



IC RATED TO BE USED WITH LED MODULE LIGHTING COMPONENT ONLY

Covered by U.S. Patent Number: **7717390B1** and other patents pending

LED LIGHTING FIXTURE CONFORMS TO **ASTM STD 119**

1-HOUR FIRE RATED

Fire rated floor/ceiling assembly refer to UL Design No. L500 & P500

2-HOUR FIRE RATED

Fire rated floor/ceiling assembly refer to UL Design No. L505

FOR MORE INFORMATION, PLEASE REFER TO THE INSTRUCTION MANUAL

NOTE - Complete system includes FS-LD5IC-AT housing and LED Modules RL500 series trim. RL500 LED Modules trim must be ordered separately.

5" 1-Hour or 2-Hour Fire-rated Recessed IC housing for use with RL500 LED series LED Module trims. **Our FIRE SHIELD Housing is designed to meet today's One or Two-Hour Fire-Rated IC & Non-IC Codes for high-rise Condominiums, Apartment Buildings, Multi-Family Residences, Hotels, Hospitalities, Assisted Living Homes, Hospitals, Health Care and many more applications.**

FIRE PROTECTION PERFORMANCE

- The luminaire ships assembled with the fire protection material already attached in their working positions
- As the fire intensifies, a protection disk seals off the bottom opening of the housing and stops the fire from passing through the fixture
- The inner assembly reacts strongly to high temperatures (428°F/220°C and above) and swells to a solid dense mass filling the entire luminaire cavity
- Prevents flames and smoke from passing through the light fixture and spreading throughout floor above
- Fire Shield recessed lighting luminaire eliminates the use of subcontractors to build additional boxes around a luminaire to achieve a 1-hour or 2-hour fire rating
- The Fire Shield family of Lighting Luminaires protect the floors above by preventing heat and flames from passing into the ceiling void
- Easier and faster to install than custom-built fireboxes and housings that require hats or additional fire-rated materials

AVAILABLE MODULE OPTIONS

Fire Shield recessed lighting luminaires are available with a variety of LED modules in different lumen packages, Kelvin temperatures, trim types, and color options. LED modules are available in a 900L lumen packages and in 27K, 30K, 35K, 40K, and 50K Kelvin temperatures. Available modules include baffle, reflector, downlight, adjustable, wall wash, and shower, in white, black, copper, bronze, satin nickel, chrome, and gold finishes.

HOUSING TYPE				
<input type="checkbox"/> FS-LD5IC-AT-DIM10-MVOLT - 0-10V Dimming Module <input type="checkbox"/> FS-LD5IC-AT-DIMTR-MVOLT - Triac Dimming Module				
TRIM TYPE	900L SERIES	CCT	CRI	FINISH
<input type="checkbox"/> RL530 (BAFFLE)	<input type="checkbox"/> 900L-DIM10-MVOLT <input type="checkbox"/> 900L-DIMTR-MVOLT	<input type="checkbox"/> 27K <input type="checkbox"/> 30K <input type="checkbox"/> 35K <input type="checkbox"/> 40K <input type="checkbox"/> 50K (CRI 85+ ONLY)	<input type="checkbox"/> 85+ <input type="checkbox"/> 90+	<input type="checkbox"/> W-WH <input type="checkbox"/> P-WH <input type="checkbox"/> SN-SN <input type="checkbox"/> CP-CP <input type="checkbox"/> BZ-BZ <input type="checkbox"/> P-BK
<input type="checkbox"/> RL511 (BAFFLE WALL WASH)				
TRIM TYPE	900L SERIES	CCT	CRI	FINISH
<input type="checkbox"/> RL507 (REFLECTOR)	<input type="checkbox"/> 900L-DIM10-MVOLT <input type="checkbox"/> 900L-DIMTR-MVOLT	<input type="checkbox"/> 27K <input type="checkbox"/> 30K <input type="checkbox"/> 35K <input type="checkbox"/> 40K <input type="checkbox"/> 50K (CRI 85+ ONLY)	<input type="checkbox"/> 85+ <input type="checkbox"/> 90+	<input type="checkbox"/> CL-WH <input type="checkbox"/> W-WH <input type="checkbox"/> BZ-BZ <input type="checkbox"/> RG-WH <input type="checkbox"/> MB-WH <input type="checkbox"/> CL-CH <input type="checkbox"/> CP-CP <input type="checkbox"/> SN-SN <input type="checkbox"/> RG-PB <input type="checkbox"/> MB-BK
<input type="checkbox"/> RL522 (REFLECTOR WALL WASH)				

SPECIFICATION

EZ-CONNECT - The FS-LD5IC-AT-DIM10-MVOLT housing is engineered with a unique 'EZ-connect' wiring system, that when used with the RL500 trim series, it will meet California Title-24 requirements. The unique EZ-connect system also meets other state and national regulatory mandates. LED Module connects effortlessly to housing, virtually eliminating mis-wiring and potential shock hazards.

HOUSING - Powdered-coated steel and galvanized steel for maximum heat dissipation and rust protection. Factory assembled with 1 or 2 hour Fire-rated components. Housing adjusts vertically in plaster frame to accommodate 1/2" to 1-3/8" thick ceiling. Housing is IC rated for direct contact with insulation and can be used in IC and NON-IC applications. May be installed in 2" x 8" joist construction.

CONNECTION - Polarity-specific EZ-connect system engineered to match with Elite LED Module trims. Meets strict code requirements where Edison Base Sockets have been banned.

BAR HANGERS - Preinstalled bar hangers allow housing to be positioned and locked at any point within a 24" joist span. They can be positioned on either the long or short axis of the housing and can be shortened for 12" joists. They contain a double-headed real nail for secure attachment into the joist. Bar hanger nails are installed on a 20° downward angle for better contact, and the 90° pivoting mounting plate makes installation fast and accurate.

JUNCTION BOX - UL Listed for through-branch circuit wiring, provided with four 1/2" knockouts, one 3/4" knockout and four Romex knockouts with true pry-out slots and strain clamps. Designed for straight through conduit runs.

AIR-SHUT ASTM E283

- Gasket to prevent air flow from heated or air conditioned spaces.
- Meets all national air flow requirements.

DIMMING INFORMATION

DIM10-MVOLT (Low Voltage 0-10 Volt Dimming)
 DIMTR 120V & 277



U. S. PATENT PENDING



Submittal form is available @ www.fireshieldlighting.com
 Tel: 323-888-1973 • Fax: 323-888-1977

Specifications and Dimensions subject to change without notice.

5" RL500 SERIES LED MODULES

RL530- **A** - **B** - **C** - **D** - **E**



(A) LUMEN SERIES	(B) VOLTAGE/DRIVER	(C) CCT	(D) CRI	(E) COLOR
<input type="checkbox"/> 900L	<input type="checkbox"/> DIM10-MVOLT <input type="checkbox"/> DIMTR-MVOLT	<input type="checkbox"/> 27K <input type="checkbox"/> 30K <input type="checkbox"/> 35K <input type="checkbox"/> 40K <input type="checkbox"/> 50K (85+ CRI ONLY)	<input type="checkbox"/> 85+ <input type="checkbox"/> 90+	<input type="checkbox"/> W-WH <input type="checkbox"/> P-BK <input type="checkbox"/> SN-SN <input type="checkbox"/> CP-CP <input type="checkbox"/> BZ-BZ <input type="checkbox"/> P-WH

LED (Retrofit) Die-cast Aluminum Lensed Stepped Baffle

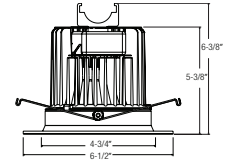

RL507- **A** - **B** - **C** - **D** - **E**



(A) LUMEN SERIES	(B) VOLTAGE/DRIVER	(C) CCT	(D) CRI	(E) COLOR
<input type="checkbox"/> 900L	<input type="checkbox"/> DIM10-MVOLT <input type="checkbox"/> DIMTR-MVOLT	<input type="checkbox"/> 27K <input type="checkbox"/> 30K <input type="checkbox"/> 35K <input type="checkbox"/> 40K <input type="checkbox"/> 50K (85+ CRI ONLY)	<input type="checkbox"/> 85+ <input type="checkbox"/> 90+	<input type="checkbox"/> CL-WH <input type="checkbox"/> W-WH <input type="checkbox"/> BZ-BZ <input type="checkbox"/> SN-SN <input type="checkbox"/> RG-WH <input type="checkbox"/> MB-WH <input type="checkbox"/> CL-CH <input type="checkbox"/> CP-CP <input type="checkbox"/> RG-PB <input type="checkbox"/> MB-BK

LED (Retrofit) Die-cast Aluminum Lensed Reflector

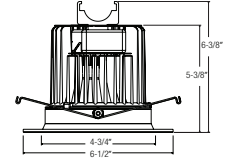

RL511- **A** - **B** - **C** - **D** - **E**



(A) LUMEN SERIES	(B) VOLTAGE/DRIVER	(C) CCT	(D) CRI	(E) COLOR
<input type="checkbox"/> 900L	<input type="checkbox"/> DIM10-MVOLT <input type="checkbox"/> DIMTR-MVOLT	<input type="checkbox"/> 27K <input type="checkbox"/> 30K <input type="checkbox"/> 35K <input type="checkbox"/> 40K <input type="checkbox"/> 50K (85+ CRI ONLY)	<input type="checkbox"/> 85+ <input type="checkbox"/> 90+	<input type="checkbox"/> W-WH <input type="checkbox"/> P-BK <input type="checkbox"/> SN-SN <input type="checkbox"/> CP-CP <input type="checkbox"/> BZ-BZ <input type="checkbox"/> P-WH

LED (Retrofit) Die-cast Aluminum Lensed Stepped Baffle Wall Wash

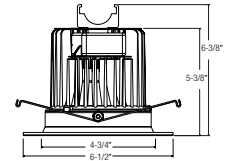

RL522- **A** - **B** - **C** - **D** - **E**



(A) LUMEN SERIES	(B) VOLTAGE/DRIVER	(C) CCT	(D) CRI	(E) COLOR
<input type="checkbox"/> 900L	<input type="checkbox"/> DIM10-MVOLT <input type="checkbox"/> DIMTR-MVOLT	<input type="checkbox"/> 27K <input type="checkbox"/> 30K <input type="checkbox"/> 35K <input type="checkbox"/> 40K <input type="checkbox"/> 50K (85+ CRI ONLY)	<input type="checkbox"/> 85+ <input type="checkbox"/> 90+	<input type="checkbox"/> CL-W-WH <input type="checkbox"/> W-W-WH <input type="checkbox"/> BZ-BZ-WH <input type="checkbox"/> SN-SN-WH <input type="checkbox"/> RG-W-WH <input type="checkbox"/> MB-W-WH <input type="checkbox"/> CL-CH-WH <input type="checkbox"/> CP-CP-WH <input type="checkbox"/> RG-PB-WH <input type="checkbox"/> MB-BK-WH

LED (Retrofit) Die-cast Aluminum Lensed Reflector Wall Wash

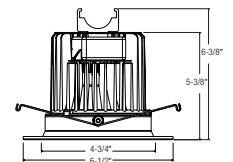

Trim Color Options



PATENT PENDING



Submittal form is available @ www.fireshieldlighting.com
Tel: 323-888-1973 • Fax: 323-888-1977

Specifications and Dimensions
subject to change without notice.