



## APPLICATIONS

The Groove 48V DC track system is available with multiple sleek, slender, and compact track heads that can be seamlessly mounted onto the track by simply clicking the track head's connector into place, allowing you to interchange one Groove-compatible luminaire for another. The Groove's intuitive click-in track makes it easy to install and switch luminaires, so the system can be updated to match any design or application, current or future.

The Groove track system is available in Trimless Recessed, Recessed Flanged, Ceiling/Surface, and Suspended options, and can be integrated in most ceiling and wall applications. Utilize suspended and surface mounting options for surface such as wood, drywall or T-Bar ceilings.

The Groove offers a variety of connector accessories that enable users to tailor their designs with custom rectangular, square, or many other linear patterns. The T, X, L Corners and power connectors create dynamic designs that transcend flat surfaces including wall to ceiling, wrap corners, and more.

Drivers can be stowed within the system, hidden from view, or placed in a remote location. The single driver can power runs up to 65' long and 480 Watts. Please refer to driver spec sheets for more detailed information. Our team at Elite Lighting can help you organize the placement of drivers and complete systems.

Fixtures can be installed individually or combined with other Groove track system luminaires to create the perfect design. Multiple linear fixtures can be mounted next to each other on one track for continuous rays of illumination.

Available track head options are in-line linear, adjustable linear, spot, pendant, cylinder, and suspended. Many track heads are crafted with black interiors and TIR optics, providing precise beam control and reducing glare. Most track heads that are available with optics are field-changeable, with various lumen and distribution options. Additionally, some track heads can be overlaid with a single optical accessory, like the Linear Diffuser, Frosted Diffuser, and Honeycomb accessories. Some track heads can be used with spot-light, flood-light, snoot, and wall-wash accessories. (Please refer to the spec sheet on each individual track head for more detailed information.)

Subsequently, the system can be used for accent, task, and general illumination, making it ideal for a plethora of applications, such as galleries, museums, hospitality spaces, retail spaces, corporate offices, and residential spaces.

## CONSTRUCTION

All track heads are engineered to have an extremely long lifespan and service period by using coolLED's Advanced Thermodynamic Design, which includes an extruded aluminum body, a hidden diecast heat sink, and a thermal management system.

## LED MODULE PERFORMANCE

The Groove System's luminaires are equipped with 2-step McAdam Eclipse LEDs, which provide consistent color across all fixtures, and 90+CRI. The LEDs are available in a variety of kelvin temperature options.

## DRIVERS

The Groove System is powered by constant voltage drivers with a rating of 50/60Hz at a 120/277V input and a 48V output. They produce less than 20% THD, have a 90% power factor, and are thermally protected for additional safety. Driver wattages range from 75W to 450W and can power up to 65' of track. Groove drivers can be installed internally within the track or remotely mounted, and are available in 0-10V 1% Dimming, Dali Dimming, or 120V On/ Off Non-Dimming Driver. Please see Groove track system spec sheets for a complete list of drivers and capabilities.

## DIMMING INFORMATION

DIM10 - 0-10V dimming on either MVOLT 120, 277. Dimmable down to 1% of initial lumens, standard. Available in 75W, 100W, 150W., 240W.  
DIMTR - Electronic low voltage dimming. Available in 120V.  
DALI - DALI DT6 dimming down to 1% Available in 75W, 100W, 150W, 240W.  
EldoLED PowerDrive dimming down to 0.1%. Please see the EldoLED website for wiring diagrams and a full list of compatible DMX and DALI control systems.

## FINISH

Luminaires are available in a powder-coated black or white post-paint finish. They may also be issued in custom RAL colors upon request. Consult the factory to find out which custom colors can be accommodated.

## WARRANTY

Five-year warranty for parts and components.

**SUSPENDED MOUNT TRACK OPTIONS**

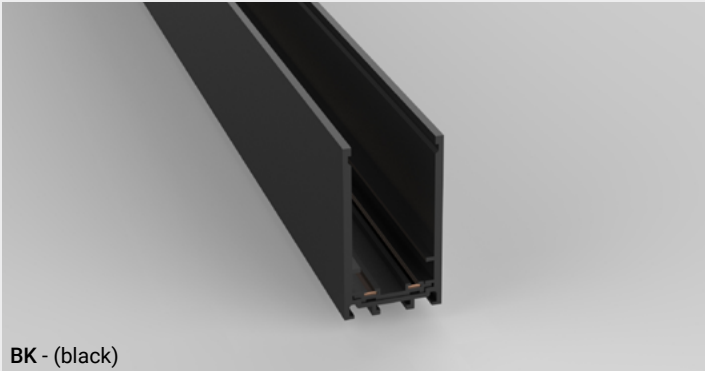

BK - (black)

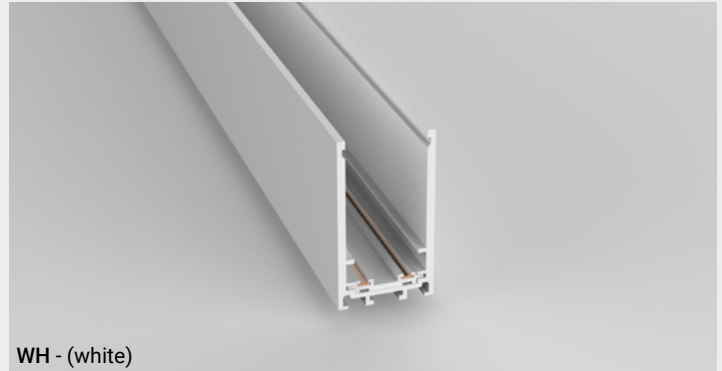

WH - (white)

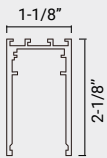

FG-SM--2  2 ft

FG-SM-4  4 ft

FG-SM-8  8 ft

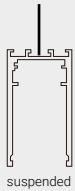

**TRACK CORNERS**

● BK - (black) ○ WH - (white)

FG-CM-SM-ACC-2

"L" track Connector for Same Plane

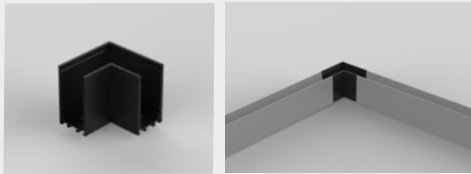
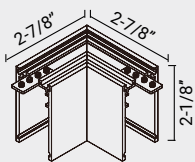

FG-CM-SM-ACC-5

"T" track Connector for Same Plane

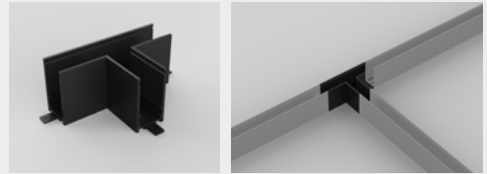
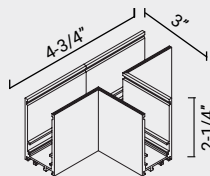

FG-CM-SM-ACC-3

"L" track Connector for inside corner of two surfaces

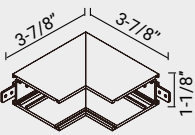

FG-CM-SM-ACC-6

"X" track Connector for inner corner of two surfaces

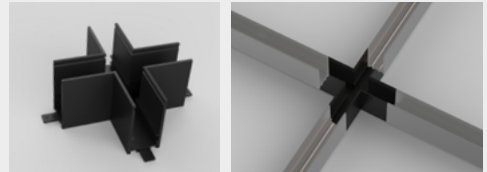
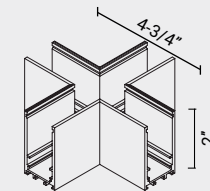

FG-CM-SM-ACC-4

"L" track Connector for outside corner of two surfaces

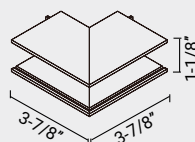

CORNERS EXAMPLE

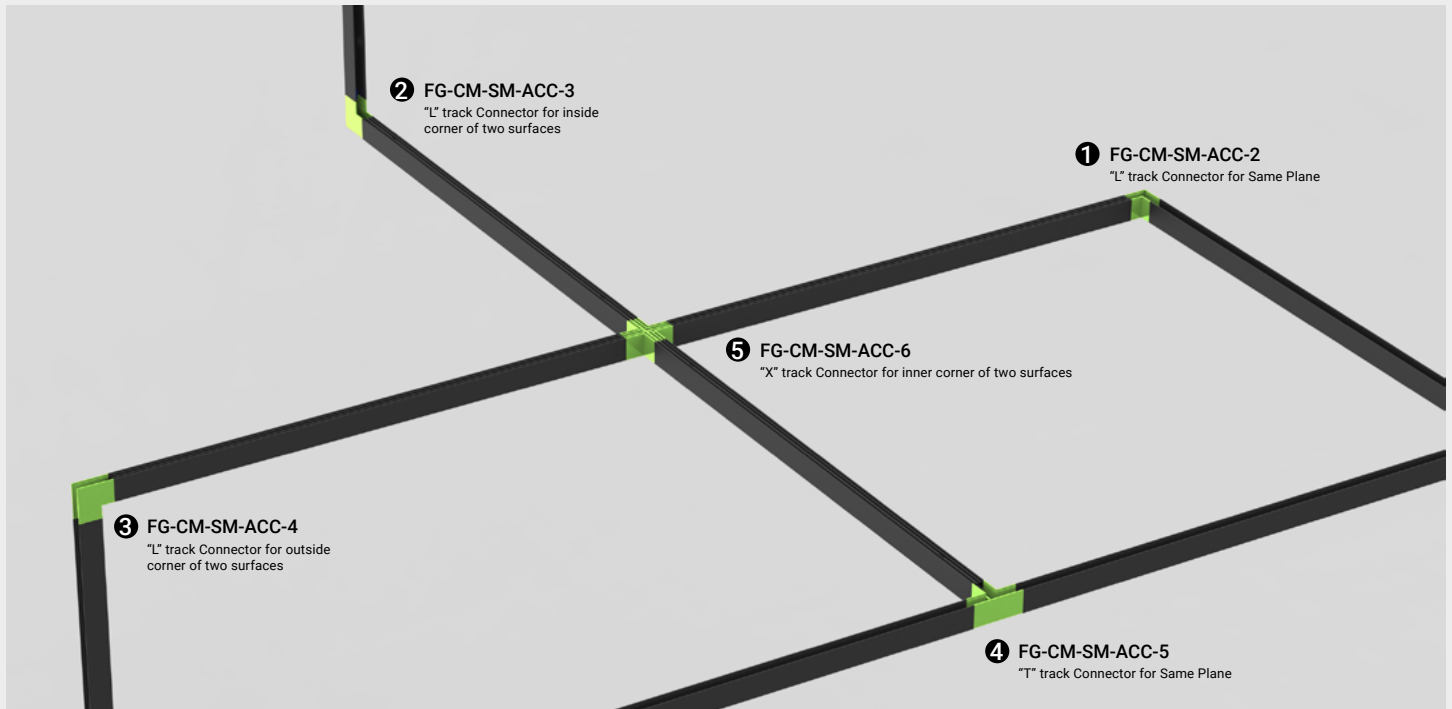

ACCESSORIES

● BK - (black) ○ WH - (white)

FG-ACC-1

Endcap (to close the open ends of tracks)

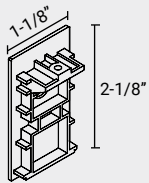

FG-ACC-2-2 (2')  
FG-ACC-2-4 (4')  
FG-ACC-2-8 (8')

Track Cover Cap (to avoid dust or decorate)

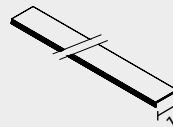

FG-SM-ACC-2

Suspended Hanging Wire (60")

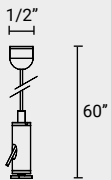

FG-SM-ACC-1

Suspended Tubular Hanging Wire (23")

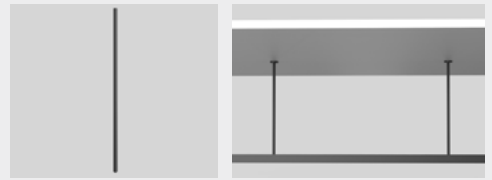
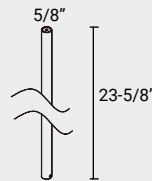

FG-SM-ACC-9

Track Connector

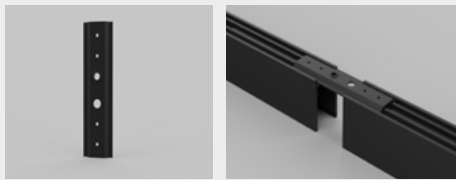

**DRIVER CONNECTIONS**

● BK - (black) ○ WH - (white)

*Install the driver into ceiling or into the actual track with the following driver box options*

**FG-ACC-3**

**Live-end with cable**

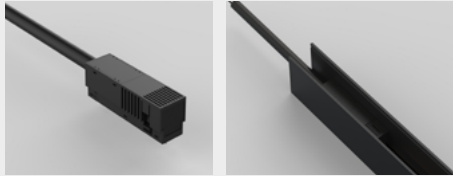
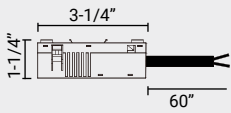

*DO NOT SLIDE IT INTO THE TRACK.*

**FG-ACC-4**

**Power Connector (Between Straight Tracks)**

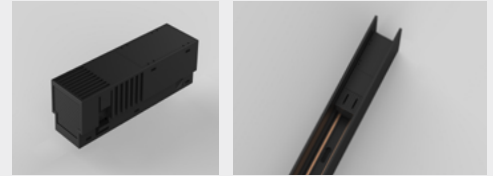
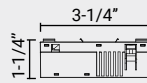

*DO NOT SLIDE IT INTO THE TRACK.*

**FG-ACC-5**

**Power Connector (flexible cable)**

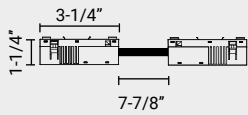

*DO NOT SLIDE IT INTO THE TRACK.*

**FG-ACC-5-L**

**Power Connector (flexible cable)**

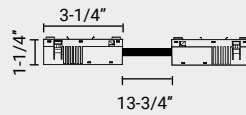

*DO NOT SLIDE IT INTO THE TRACK.*

**POWER TO THE CEILING:**

*Insert the cable of live-in accessory to connect power from the ceiling to the track.*

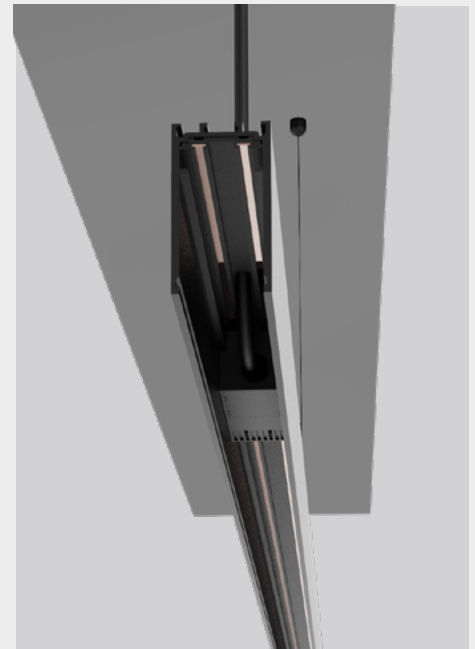

**INTERNAL DRIVER OPTIONS (with box):** ● BK - (black) ○ WH - (white)

Install the driver into ceiling or into the actual track with the following driver box options

**FG-DI-200W-ON-OFF-48V**

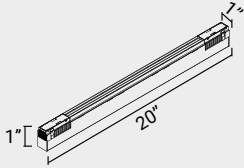

**Voltage: 120V**  
**Maximum Load: 200W**  
**Dimming Option: Power ON/OFF**

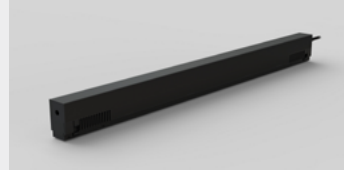

**FG-DI-200W-10V-DIM-48V**

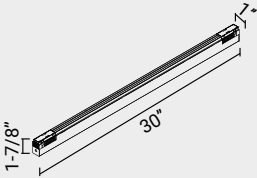

**Voltage: 120V**  
**Maximum Load: 200W**  
**Dimming Option: 0-10V Dimmable**

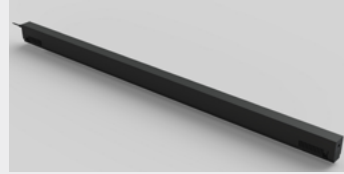

**FG-DI-200W-DALI-48V**

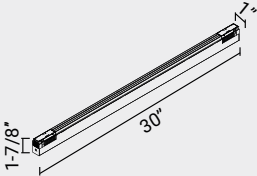

**Voltage: 120V**  
**Maximum Load: 200W**  
**Dimming Option: Dali Dimmable**

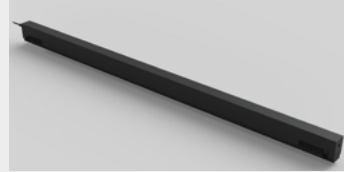

**EXTERNAL DRIVER OPTIONS (with box):**

**FG-DR-75W-ON-OFF-48V | FG-DR-75W-10V-DIM-48V | FG-DR-75W-DALI-48V**

FG-DR-75W-48V Series Constant Voltage + Constant Current Driver								
Model	Input Voltage	Output Voltage	Wattage (@120VAC)	Wattage (@277VAC)	Rated Current	Efficiency	Frequency	Power Factor (Normal)
FG-DR-75W-48V	120-277VAC 2	24-48V	60W	76.8W	1.6A	90%	50-60Hz	.9

\*0-10V & DALI dimming only\*

**FG-DR-100W-ON-OFF-48V | FG-DR-100W-10V-DIM-48V | FG-DR-100W-DALI-48V**

FG-DR-100W-48V Constant Voltage + Constant Current Driver								
Model	Input Voltage	Output Voltage	Wattage (@120VAC)	Wattage (@277VAC)	Rated Current	Efficiency	Frequency	Power Factor (Normal)
FG-DR-100W-48V	120-277VAC	24-48V	70W	96W	2A	90%	50-60Hz	.9

\*0-10V & DALI dimming only\*

**EXTERNAL DRIVER OPTIONS:**

**FG-DR-150W-ON-OFF-48V | FG-DR-150W-10V-DIM-48V | FG-DR-150W-DALI-48V**

FG-DR-150W-48V Series Constant Voltage + Constant Current Driver								
Model	Input Voltage	Output Voltage	Wattage * (@120VAC)	Wattage * (@277VAC)	Rated Current *	Efficiency *	Frequency	Power Factor (Normal)
FG-DR-150W-48V	120-277VAC	24-48V	105W	150W	3A	90%	50-60Hz	.9

\*0-10V & DALI dimming only\*  
\*Type BE has different Wattage, Current & Efficiency See Chart Below\*

**FG-DR-200W-ON-OFF-48V | FG-DR-200W-10V-DIM-48V | FG-DR-200W-DALI-48V**

FG-DR-200W-48V Series Constant Voltage + Constant Current Driver								
Model	Input Voltage	Output Voltage	Wattage * (@120VAC)	Wattage * (@277VAC)	Rated Current *	Efficiency *	Frequency	Power Factor (Normal)
FG-DR-200W-48V	120-277VAC	24-48V	150W	200W	4.16A	93%	50-60Hz	.9

\*0-10V & DALI dimming only\*

**FG-DR-320W-ON-OFF-48V | FG-DR-320W-10V-DIM-48V | FG-DR-320W-DALI-48V**

FG-DR-320W-48V Series Constant Voltage + Constant Current Driver								
Model	Input Voltage	Output Voltage	Wattage * (@120VAC)	Wattage * (@277VAC)	Rated Current *	Efficiency *	Frequency	Power Factor (Normal)
FG-DR-320W-48V	120-277VAC	24-48V	320W	320W	6A	95%	50-60Hz	.9

\*0-10V & DALI dimming only\*

**FG-DR-480W-ON-OFF-48V | FG-DR-480W-10V-DIM-48V | FG-DR-480W-DALI-48V**

FG-DR-480W-48V Series Constant Voltage + Constant Current Driver								
Model	Input Voltage	Output Voltage	Wattage * (@120VAC)	Wattage * (@277VAC)	Rated Current *	Efficiency *	Frequency	Power Factor (Normal)
FG-DR-480W-48V	120-277VAC	24-48V	480W	480W	10A	94%	50-60Hz	.9

\*0-10V & DALI dimming only\*

**DRIVER:** FG-DR-75W-48V

Unit: Inches

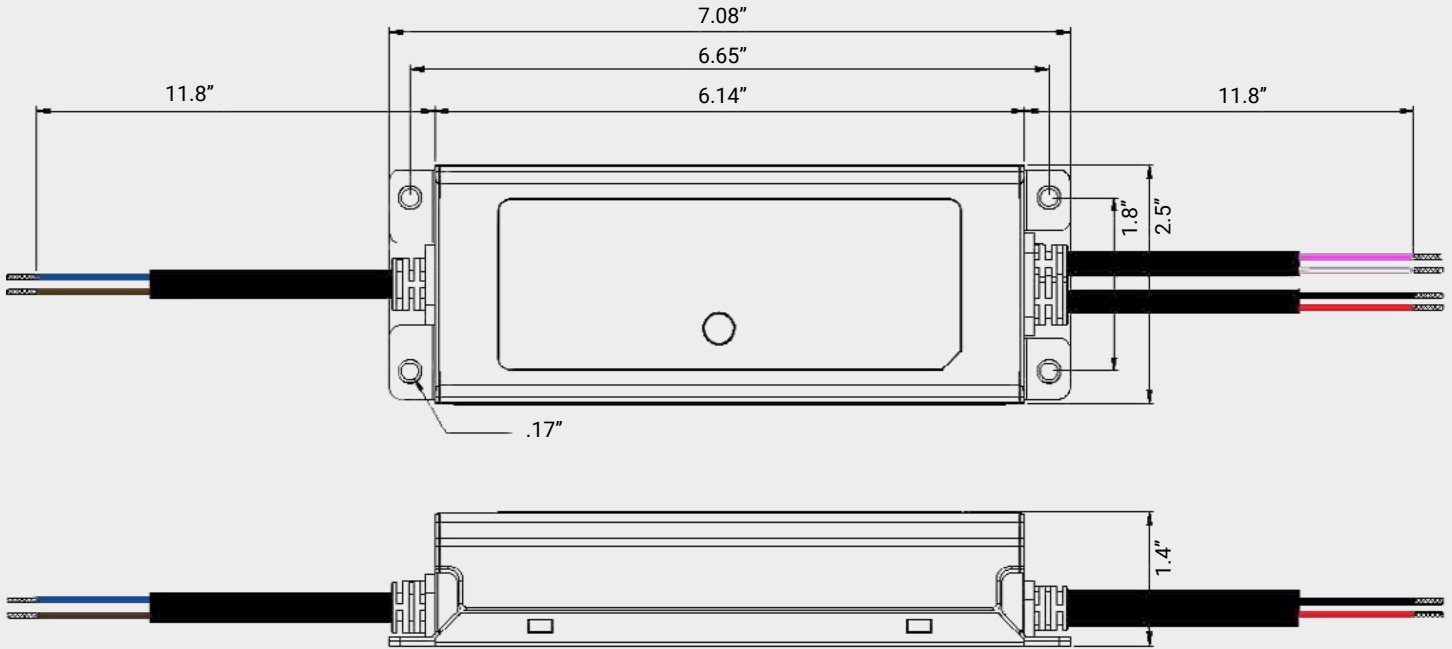

**DRIVER:** FG-DR-100W-48V

Unit: Inches

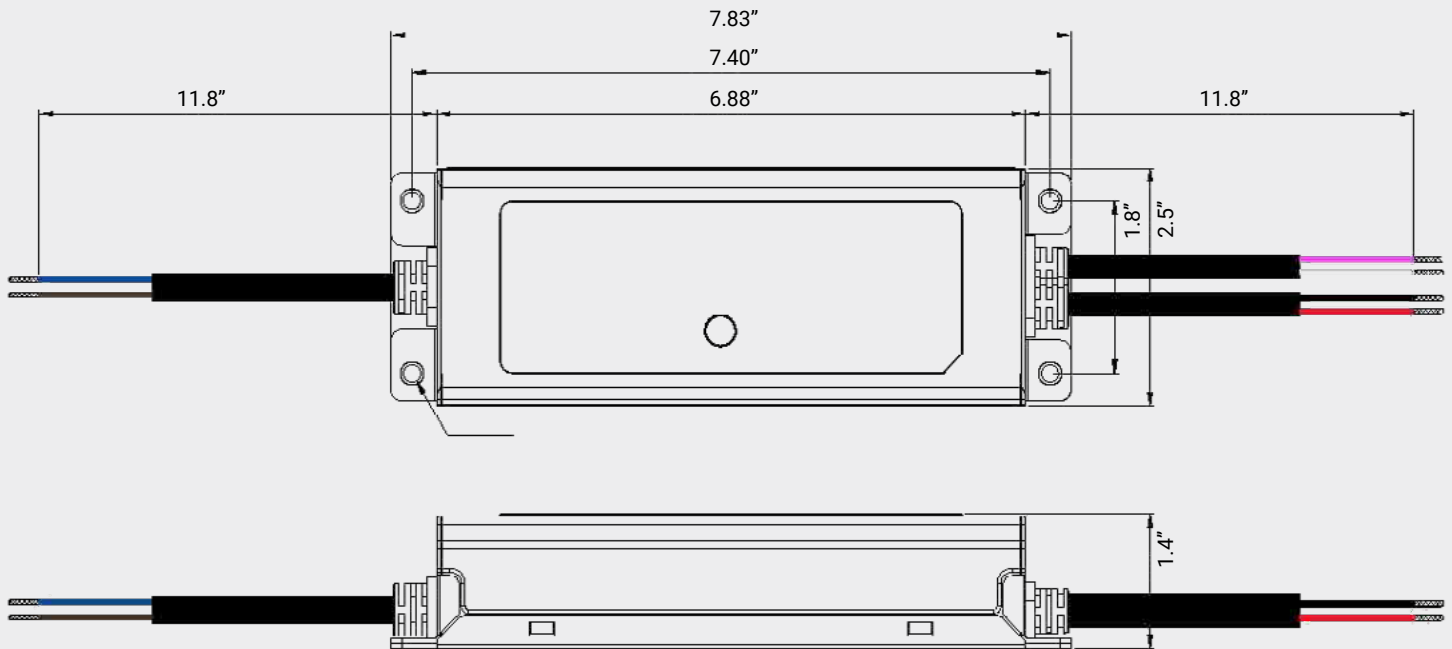

**DRIVER:** FG-DR-150W-48V

Unit: Inches

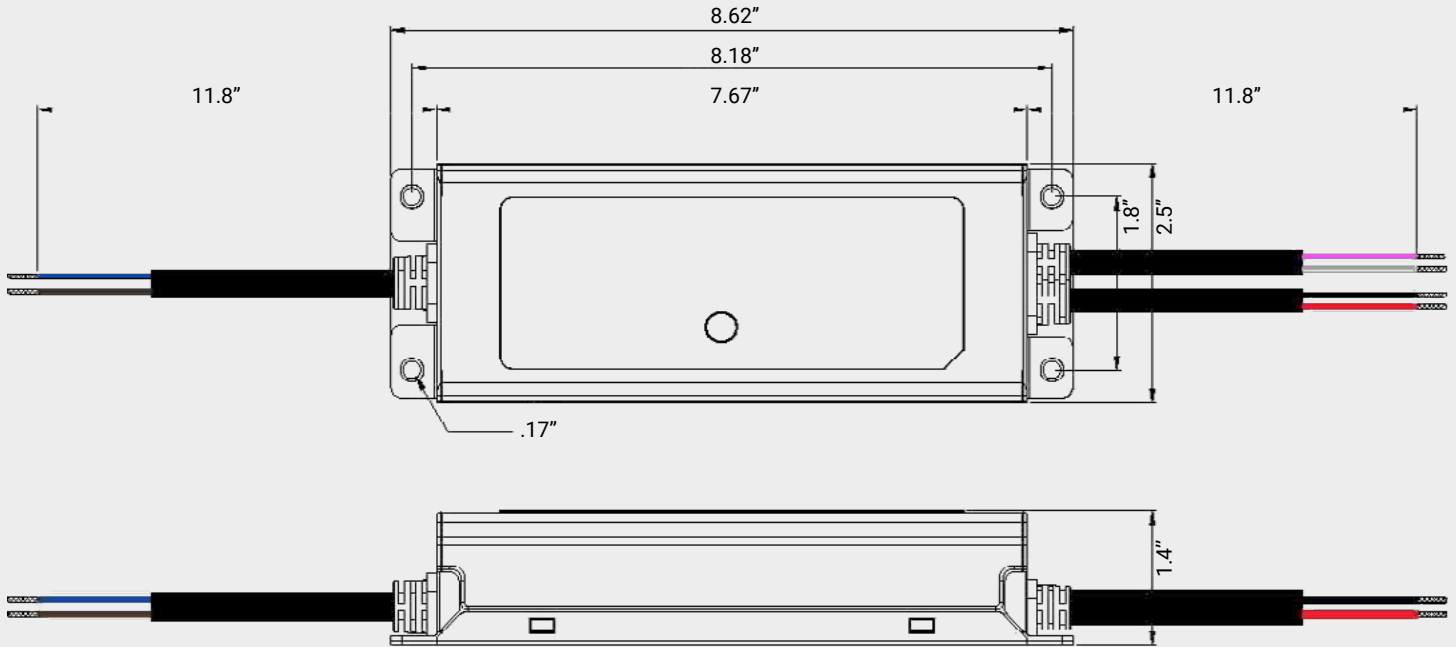

**DRIVER:** FG-DR-200W-48V

Unit: Inches

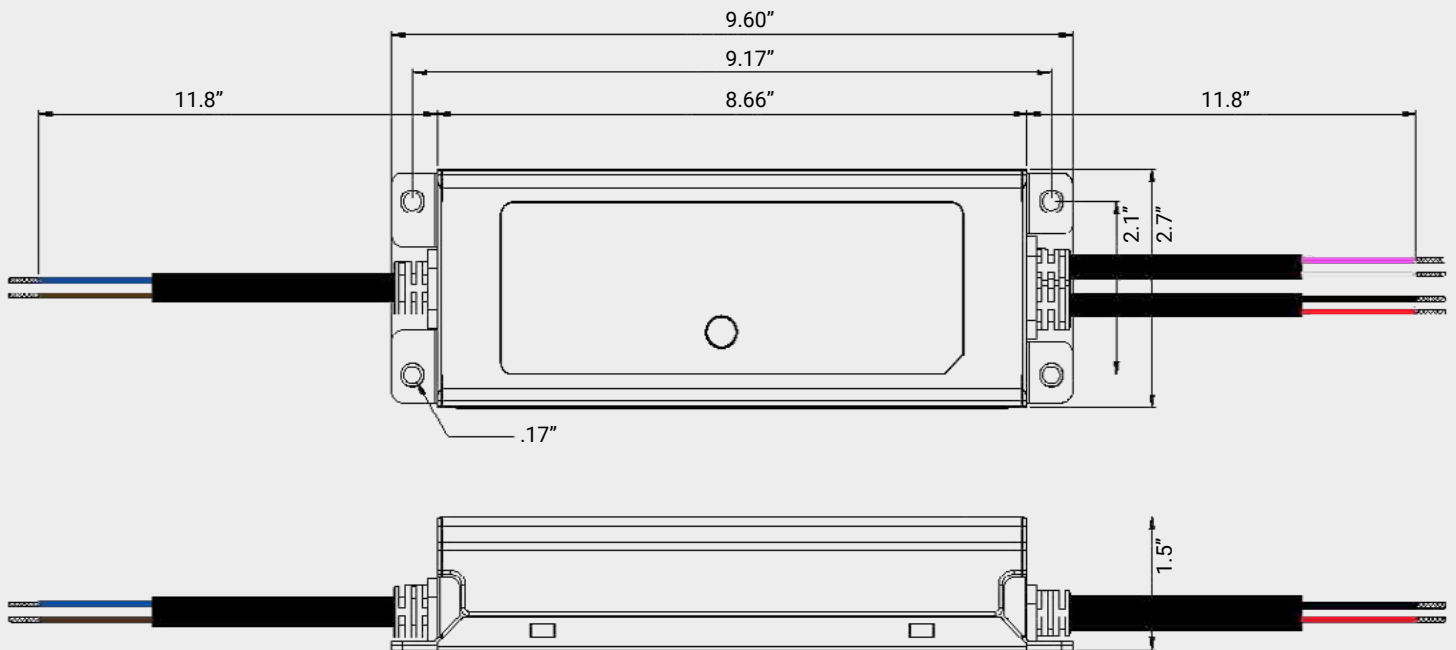



**DRIVER: FG-DR-320W-48V**

Unit: Inches

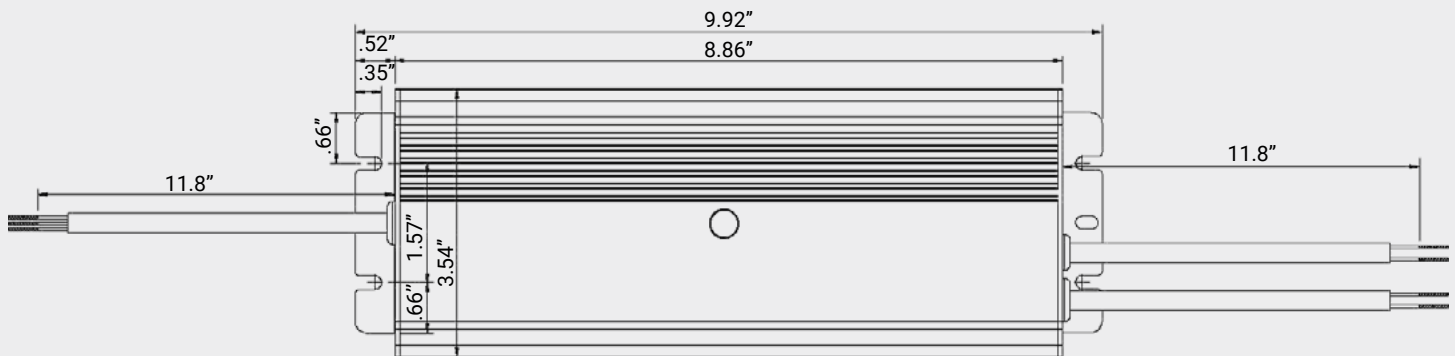

**DRIVER: FG-DR-480W-48V**

Unit: Inches

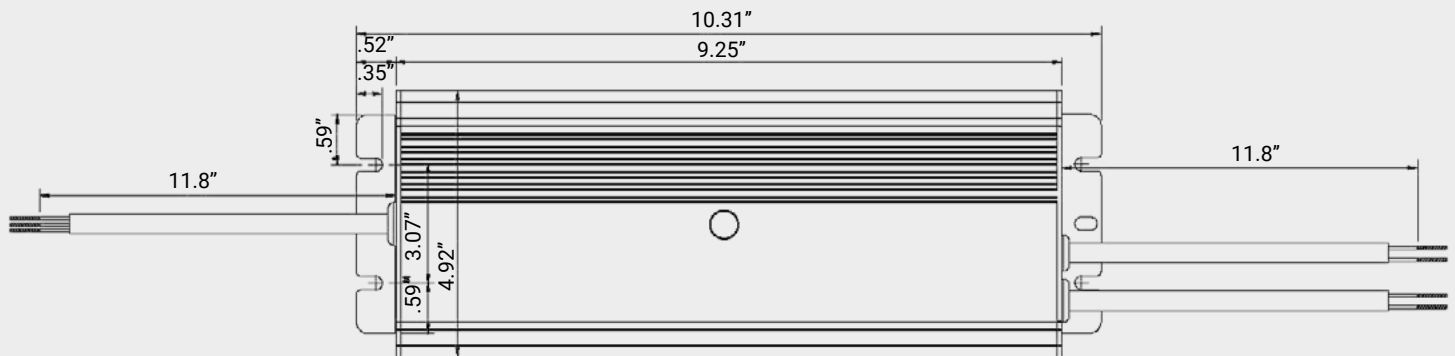

**DRIVER BOX DIMENSION**

Unit: Inches

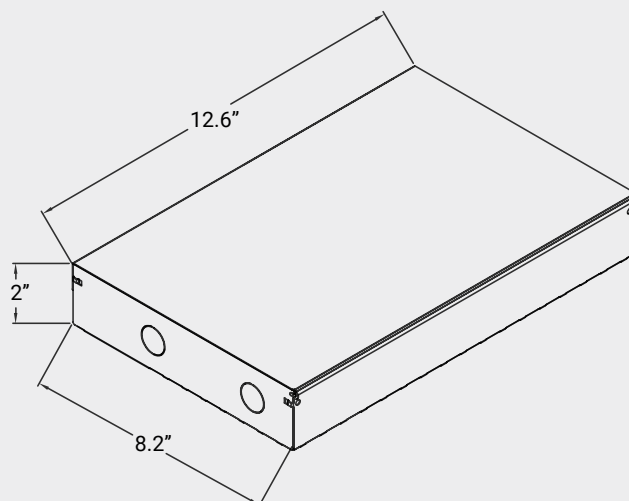

**LIGHT MODULE EXAMPLES**

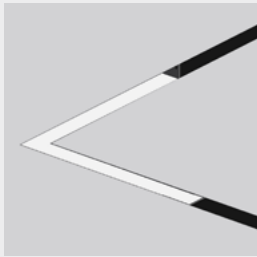

Seamless Linear Diffused  
Corners  
*FG-L1R-C90 / CI / CO*

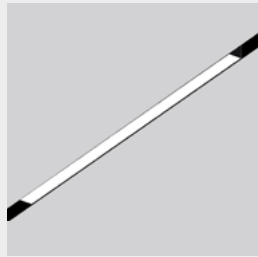

Seamless Linear Diffused  
*FG-L1R-8 / 16 / 32 / 48 / 64*

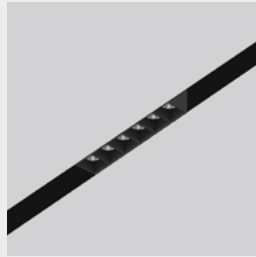

Linear Downlight  
*FG-L4R-3 / 5 / 8 / 16 / 32*

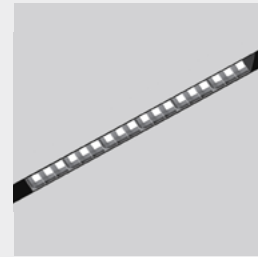

Linear Louvered  
*FG-L3R-16 / 32*

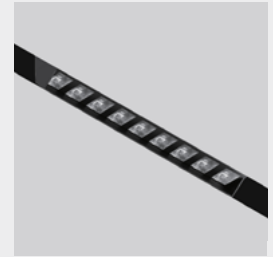

Wall Wash  
*FG-L1-WW-3 / 8*



Linear Diffused & Adjustable  
Light  
*FG-L2A-3 / 5 / 8*

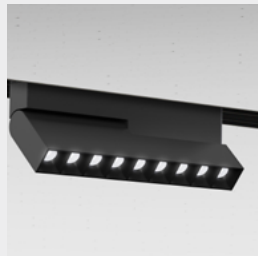

Linear Adjustable Downlight,  
Task & Wall Grazer  
*FG-L4A-3 / 5 / 8*



Recessed Track Light  
*FG-T1-1*

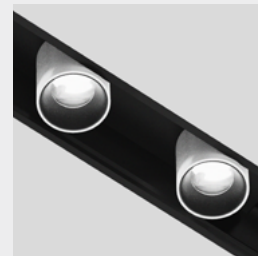

Recessed Track Light  
*FG-T1-2*



Cylinder  
*FG-T2-1 / 2 / 3*

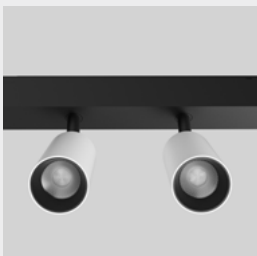

Cylinder  
*FG-T2-4*

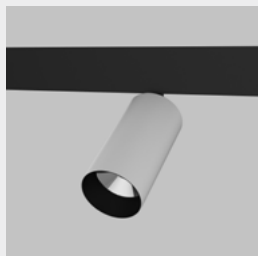

Cylinder  
*FG-T3-1 / 2 / 3*



Beam Adjustable Cylinder  
*FG-T4-1 / 2 / 3*



Projector  
*FG-TPJ-1*



Gobo Projector  
*FG-TPJ-2*

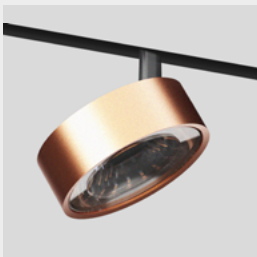

Flat Round  
*FG-T5-1 / 2*



Flat Square  
*FG-T6-1 / 2*



Rectangle Track Light  
*FG-T7-2*

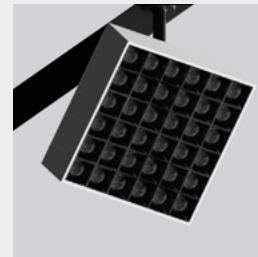

Square Track Light  
*FG-T7-1 / 3*

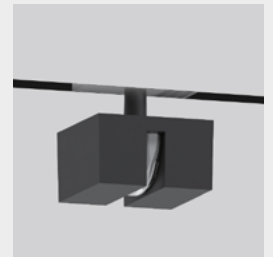

Line Light  
*FG-LL-1*

**LIGHT MODULE EXAMPLES**



Wall Light

*FG-WL-1*



Wall Light

*FG-WL-2*

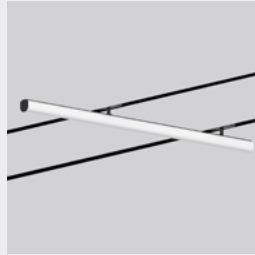

Linear Surface Light

*FG-L5S-32 / 48*



Linear Surface Light

*FG-L2S-32 / 48*

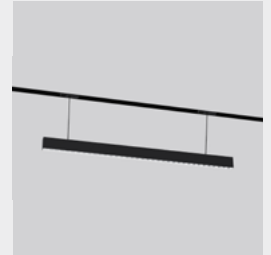

Pendant Louvered

*FG-L1P-32*



Pendant

*FG-P1-1 / 2*



Pendant

*FG-P3-1 / 2*



Track Globe

*FG-T8-1*



Track Globe

*FG-T9-1*

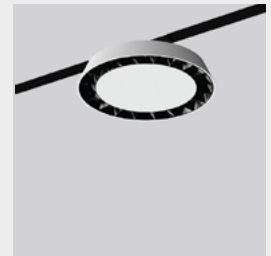

Track Downlight

*FG-T10-1*



Pendant Globe

*FG-P4-1*



Pendant Globe

*FG-P4-2*

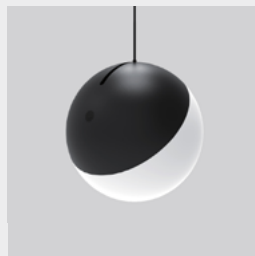

Pendant Globe

*FG-P4-3*



Globe

*FG-T11-1*



Globe

*FG-P5-1*

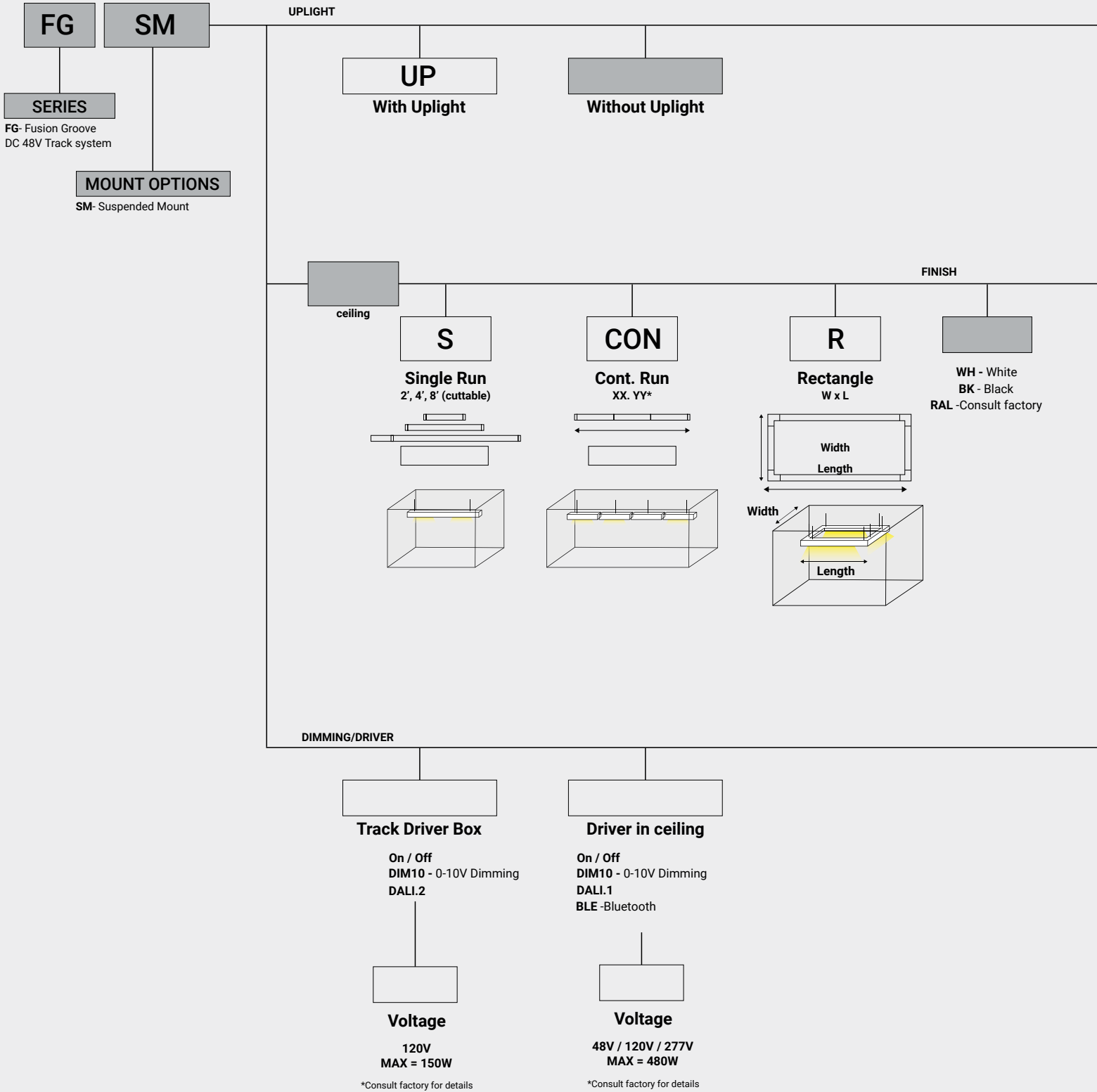

GROOVE SUSPENDED MOUNT CONFIGURATION EXAMPLES:

■ TRACK □ ENDCAP & CORNERS ○ HANGING WIRES

