



APPLICATIONS

The Groove 48V DC track system is available with multiple sleek, slender, and compact track heads that can be seamlessly mounted onto the track by simply clicking the track head's connector into place, allowing you to interchange one Groove-compatible luminaire for another. The Groove's intuitive click-in track makes it easy to install and switch luminaires, so the system can be updated to match any design or application, current or future.

The Groove track system is available in Trimless Recessed, Recessed Flanged, Ceiling/Surface, and Suspended options, and can be integrated in most ceiling and wall applications. Utilize suspended and surface mounting options for surface such as wood, drywall or T-Bar ceilings.

The Groove offers a variety of connector accessories that enable users to tailor their designs with custom rectangular, square, or many other linear patterns. The T, X, L Corners and power connectors create dynamic designs that transcend flat surfaces including wall to ceiling, wrap corners, and more.

Drivers can be stowed within the system, hidden from view, or placed in a remote location. The single driver can power runs up to 65' long and 480 Watts. Please refer to driver spec sheets for more detailed information. Our team at Elite Lighting can help you organize the placement of drivers and complete systems.

Fixtures can be installed individually or combined with other Groove track system luminaires to create the perfect design. Multiple linear fixtures can be mounted next to each other on one track for continuous rays of illumination.

Available track head options are in-line linear, adjustable linear, spot, pendant, cylinder, and suspended. Many track heads are crafted with black interiors and TIR optics, providing precise beam control and reducing glare. Most track heads that are available with optics are field-changeable, with various lumen and distribution options. Additionally, some track heads can be overlaid with a single optical accessory, like the Linear Diffuser, Frosted Diffuser, and Honeycomb accessories. Some track heads can be used with spot-light, flood-light, snoot, and wall-wash accessories. (Please refer to the spec sheet on each individual track head for more detailed information.)

Subsequently, the system can be used for accent, task, and general illumination, making it ideal for a plethora of applications, such as galleries, museums, hospitality spaces, retail spaces, corporate offices, and residential spaces.

CONSTRUCTION

All track heads are engineered to have an extremely long lifespan and service period by using coolLED's Advanced Thermodynamic Design, which includes an extruded aluminum body, a hidden diecast heat sink, and a thermal management system.

LED MODULE PERFORMANCE

The Groove System's luminaires are equipped with 2-step McAdam Eclipse LEDs, which provide consistent color across all fixtures, and 90+CRI. The LEDs are available in a variety of kelvin temperature options.

DRIVERS

The Groove System is powered by constant voltage drivers with a rating of 50/60Hz at a 120/277V input and a 48V output. They produce less than 20% THD, have a 90% power factor, and are thermally protected for additional safety. Driver wattages range from 75W to 450W and can power up to 65' of track. Groove drivers can be installed internally within the track or remotely mounted, and are available in 0-10V 1% Dimming, Dali Dimming, or 120V On/ Off Non-Dimming Driver. Please see Groove track system spec sheets for a complete list of drivers and capabilities.

DIMMING INFORMATION

DIM10 - 0-10V dimming on either MVOLT 120, 277. Dimmable down to 1% of initial lumens, standard. Available in 75W, 100W, 150W, 240W.
DIMTR - Electronic low voltage dimming. Available in 120V.
DALI - DALI DT6 dimming down to 1% Available in 75W, 100W, 150W, 240W.
EldoLED PowerDrive dimming down to 0.1%. Please see the EldoLED website for wiring diagrams and a full list of compatible DMX and DALI control systems.
BLE - Luminaires may be controlled, grouped, scheduled or placed in scenes and or zones Via Cassambi Bluetooth 4.0 App.

FINISH

Luminaires are available in a powder-coated black or white post-paint finish. They may also be issued in custom RAL colors upon request. Consult the factory to find out which custom colors can be accommodated.

WARRANTY

Five-year warranty for parts and components.

RECESSED TRACK OPTIONS

● BK - (black) ○ WH - (white)

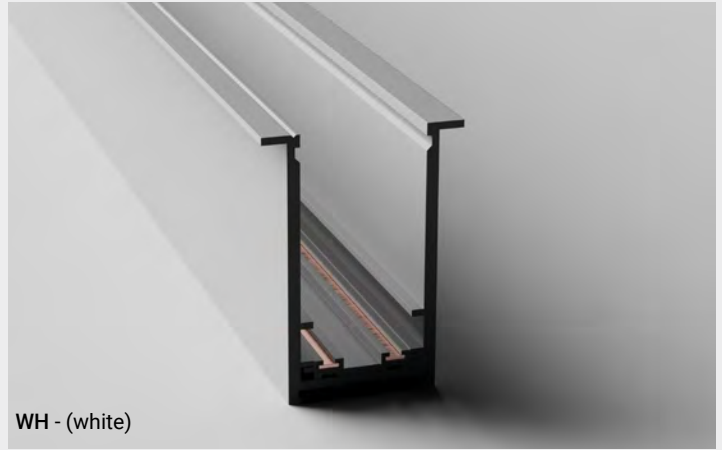

BK - (black)

WH - (white)

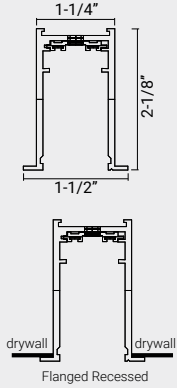

FG-RF-2 2 ft

FG-RF-4 4 ft

FG-RF-8 8 ft

TRACK CORNERS

● BK - (black) ○ WH - (white)

FG-RF-ACC-2

"L" track Connector for Same Plane

FG-RF-ACC-5

"T" track Connector for Same Plane

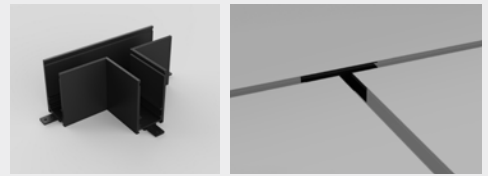
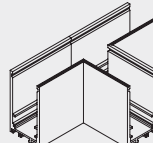
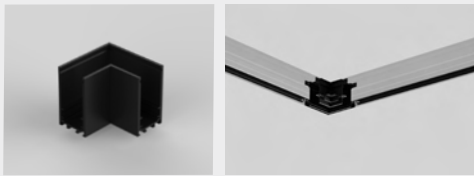
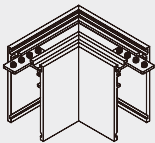

FG-RF-ACC-3

"L" track Connector for inside corner of two surfaces

FG-RF-ACC-6

"X" track Connector for inner corner of two surfaces

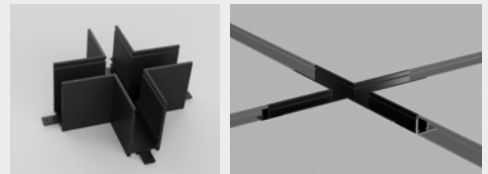
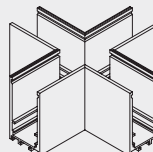
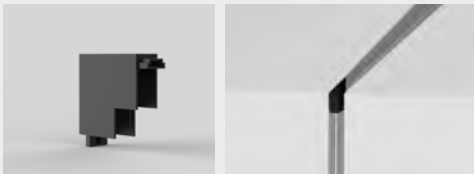

FG-RF-ACC-4

"L" track Connector for outside corner of two surfaces

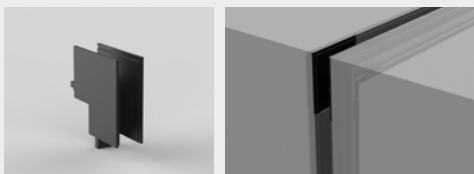
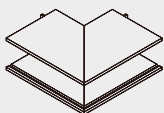

CORNERS EXAMPLE

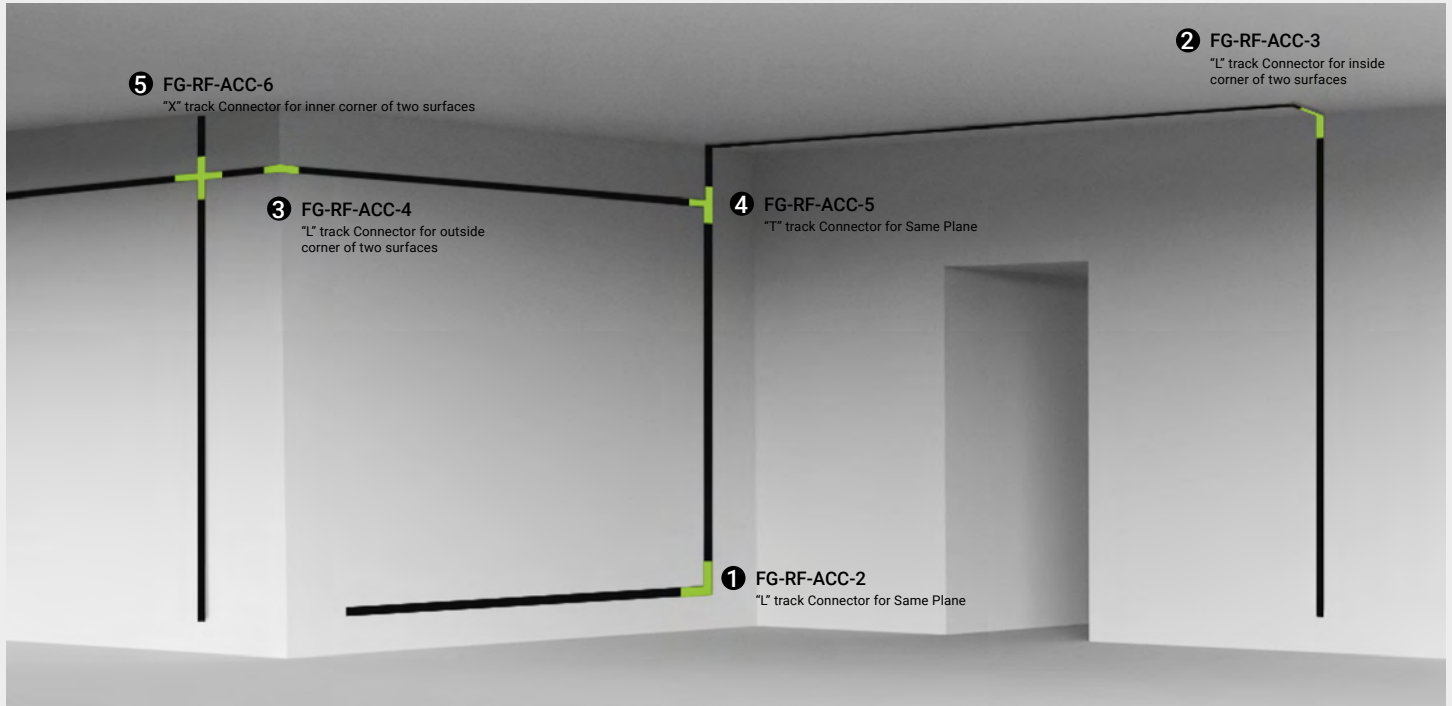

ACCESSORIES

● BK - (black) ○ WH - (white)

FG-ACC-1

Endcap (to close the open ends of tracks)

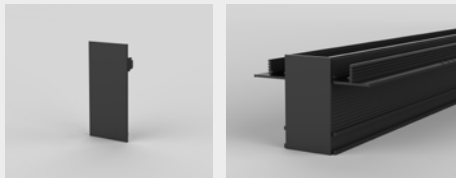
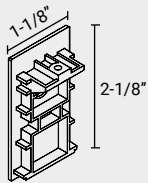

FG-ACC-2-2 (2')
FG-ACC-2-4 (4')
FG-ACC-2-8 (8')

Track Cover Cap (to avoid dust or decorate)

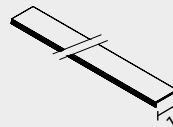

FG-ACC-3

Live-end with cable

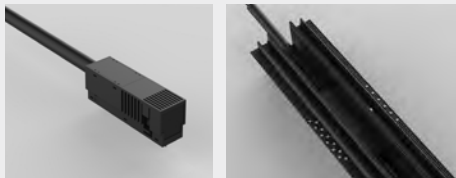
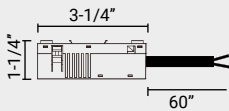

DO NOT SLIDE IT INTO THE TRACK.

FG-ACC-4

Power Connector (Between Straight Tracks)

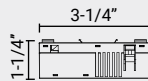

DO NOT SLIDE IT INTO THE TRACK.

FG-ACC-5

Power Connector (flexible cable)

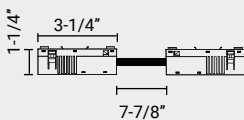

DO NOT SLIDE IT INTO THE TRACK.

FG-ACC-5-L

Power Connector for 'T' form Corners (flexible cable)

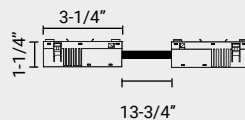

DO NOT SLIDE IT INTO THE TRACK.

FG-ACC-9

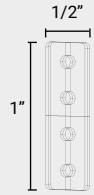

Track Connector

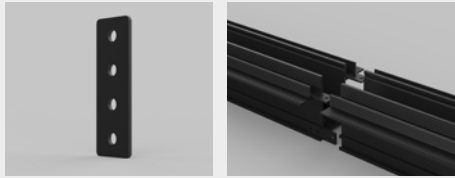

INTERNAL DRIVER OPTIONS (with box): ● BK - (black) ○ WH - (white)

Install the driver into ceiling or into the actual track with the following driver box options

FG-DI-200W-ON-OFF-48V

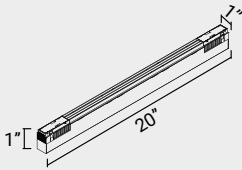

Voltage: 120V
Maximum Load: 200W
Dimming Option: Power ON/OFF

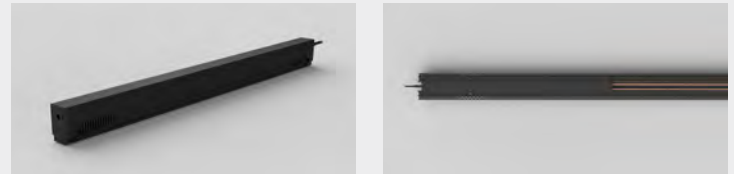

FG-DI-200W-10V-DIM-48V

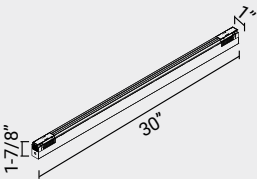

Voltage: 120V
Maximum Load: 200W
Dimming Option: 0-10V Dimmable

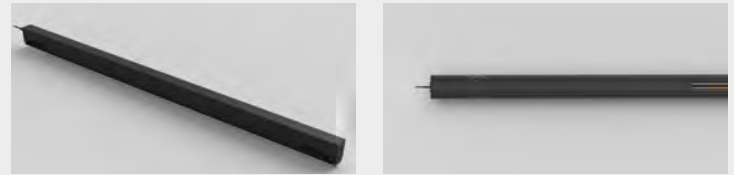

FG-DI-200W-DALI-48V

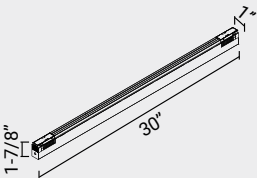

Voltage: 120V
Maximum Load: 200W
Dimming Option: Dali Dimmable

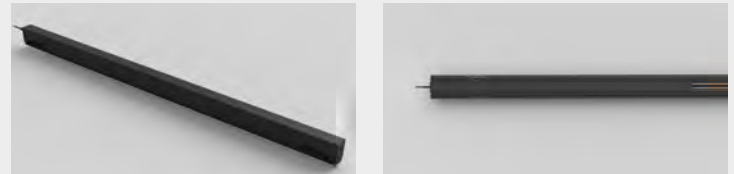

EXTERNAL DRIVER OPTIONS (with box):

FG-DR-75W-ON-OFF-48V | FG-DR-75W-DALI-48V | FG-DR-75W-10V-DIM-48V

FG-DR-75W-48V Series Constant Voltage + Constant Current Driver								
Model	Input Voltage	Output Voltage	Wattage (@120VAC)	Wattage (@277VAC)	Rated Current	Efficiency	Frequency	Power Factor (Normal)
FG-DR-75W-48V	120-277VAC 2	24-48V	60W	76.8W	1.6A	90%	50-60Hz	.9

0-10V & DALI dimming only

EXTERNAL DRIVER OPTIONS:

FG-DR-100W-ON-OFF-48V | FG-DR-100W-DALI-48V | FG-DR-100W-10V-DIM-48V

FG-DR-100W-48V Series Constant Voltage + Constant Current Driver								
Model	Input Voltage	Output Voltage	Wattage (@120VAC)	Wattage (@277VAC)	Rated Current	Efficiency	Frequency	Power Factor (Normal)
FG-DR-100W-48V	120-277VAC	24-48V	70W	96W	2A	90%	50-60Hz	.9

0-10V & DALI dimming only

FG-DR-150W-ON-OFF-48V | FG-DR-150W-DALI-48V | FG-DR-150W-10V-DIM-48V

FG-DR-150W-48V Series Constant Voltage + Constant Current Driver								
Model	Input Voltage	Output Voltage	Wattage * (@120VAC)	Wattage * (@277VAC)	Rated Current *	Efficiency *	Frequency	Power Factor (Normal)
FG-DR-150W-48V	120-277VAC	24-48V	105W	150W	3A	90%	50-60Hz	.9

0-10V & DALI dimming only

Type BE has different Wattage, Current & Efficiency See Chart Below

FG-DR-200W-ON-OFF-48V | FG-DR-200W-DALI-48V | FG-DR-200W-10V-DIM-48V

FG-DR-200W-48V Series Constant Voltage + Constant Current Driver								
Model	Input Voltage	Output Voltage	Wattage * (@120VAC)	Wattage * (@277VAC)	Rated Current *	Efficiency *	Frequency	Power Factor (Normal)
FG-DR-200W-48V	120-277VAC	24-48V	150W	200W	4.16A	93%	50-60Hz	.9

0-10V & DALI dimming only

FG-DR-320W-ON-OFF-48V | FG-DR-320W-DALI-48V | FG-DR-320W-10V-DIM-48V

FG-DR-320W-48V Series Constant Voltage + Constant Current Driver								
Model	Input Voltage	Output Voltage	Wattage * (@120VAC)	Wattage * (@277VAC)	Rated Current *	Efficiency *	Frequency	Power Factor (Normal)
FG-DR-320W-48V	120-277VAC	24-48V	320W	320W	6A	95%	50-60Hz	.9

0-10V & DALI dimming only

FG-DR-480W-ON-OFF-48V | FG-DR-480W-DALI-48V | FG-DR-480W-10V-DIM-48V

FG-DR-480W-48V Series Constant Voltage + Constant Current Driver								
Model	Input Voltage	Output Voltage	Wattage * (@120VAC)	Wattage * (@277VAC)	Rated Current *	Efficiency *	Frequency	Power Factor (Normal)
FG-DR-480W-48V	120-277VAC	24-48V	480W	480W	10A	94%	50-60Hz	.9

0-10V & DALI dimming only

DRIVER: FG-DR-75W-48V

Unit: Inches

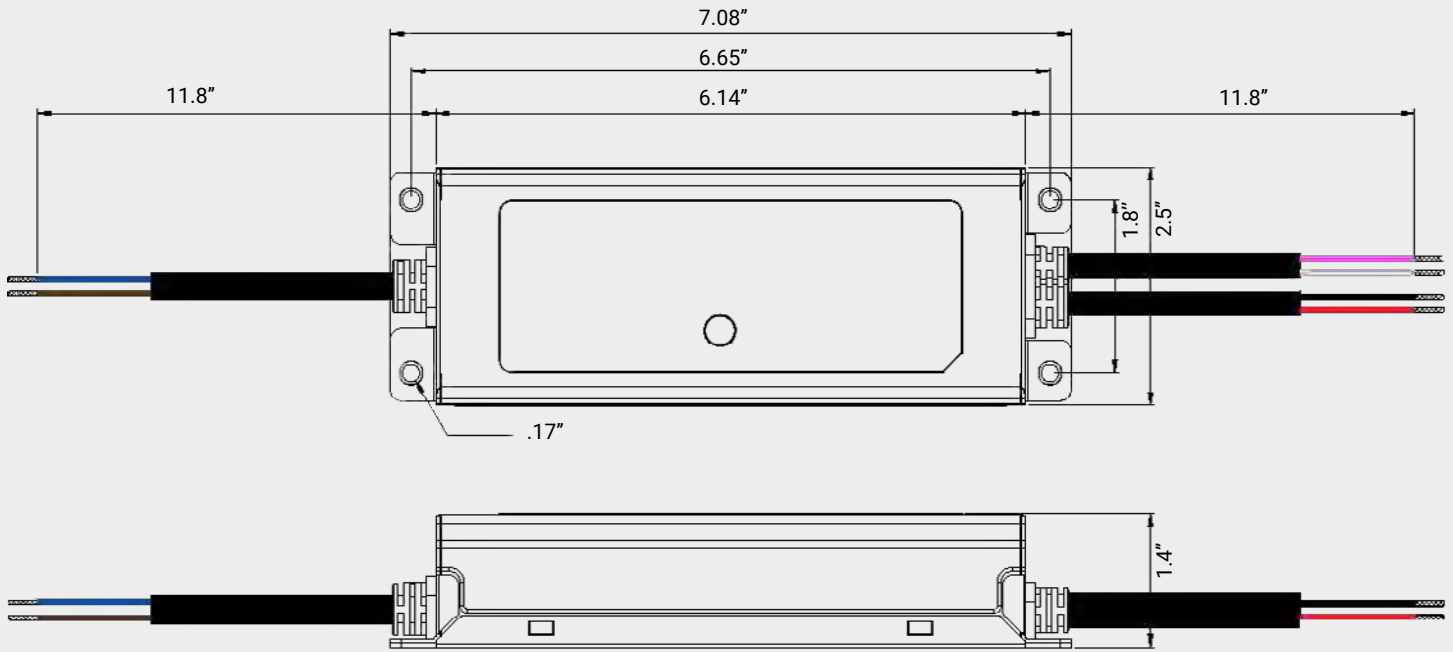

FG-DR-ELG-100-48

DRIVER: FG-DR-100W-48V

Unit: Inches

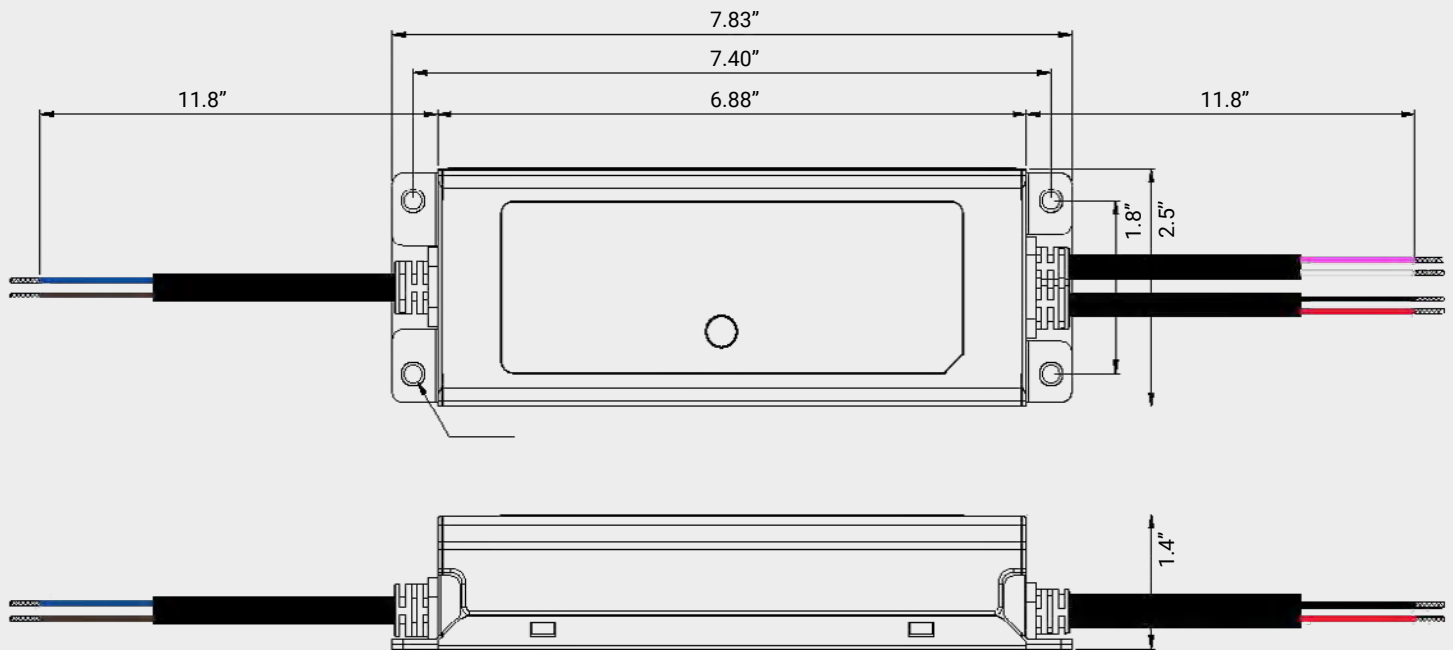

DRIVER: FG-DR-150W-48V

Unit: Inches

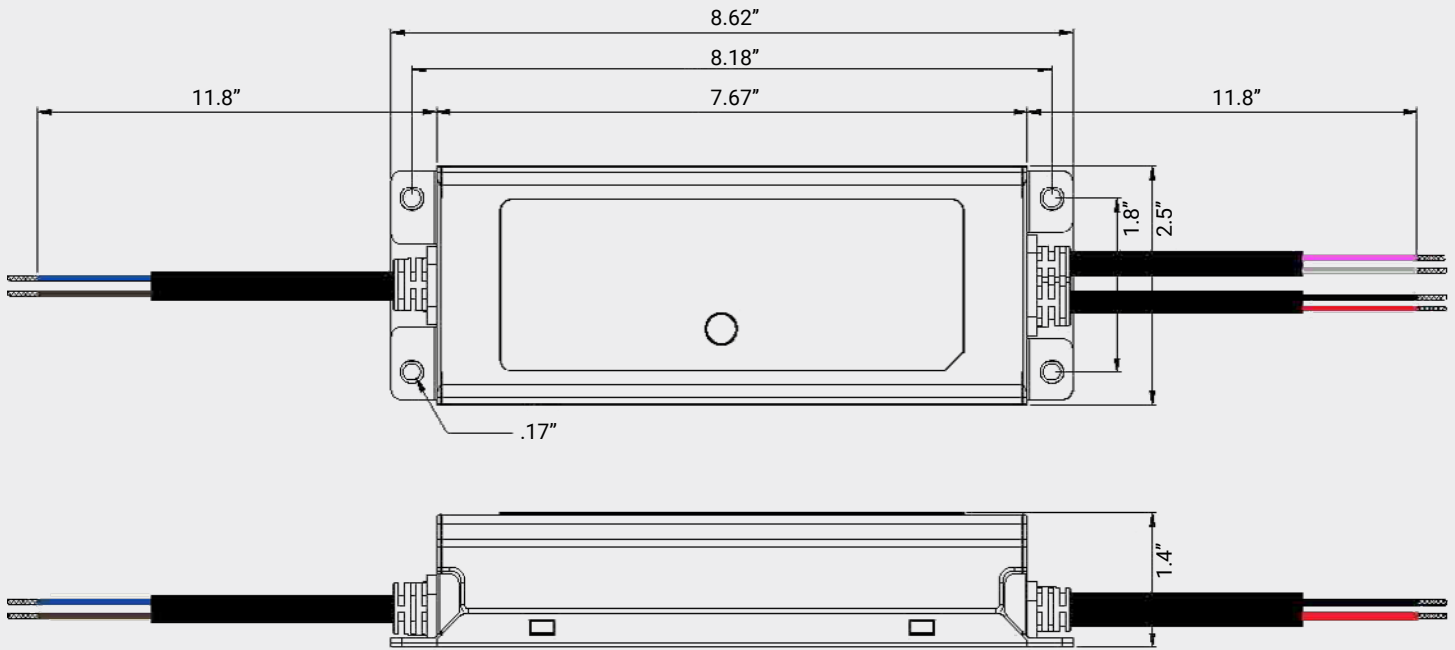

DRIVER: FG-DR-200W-48V

Unit: Inches

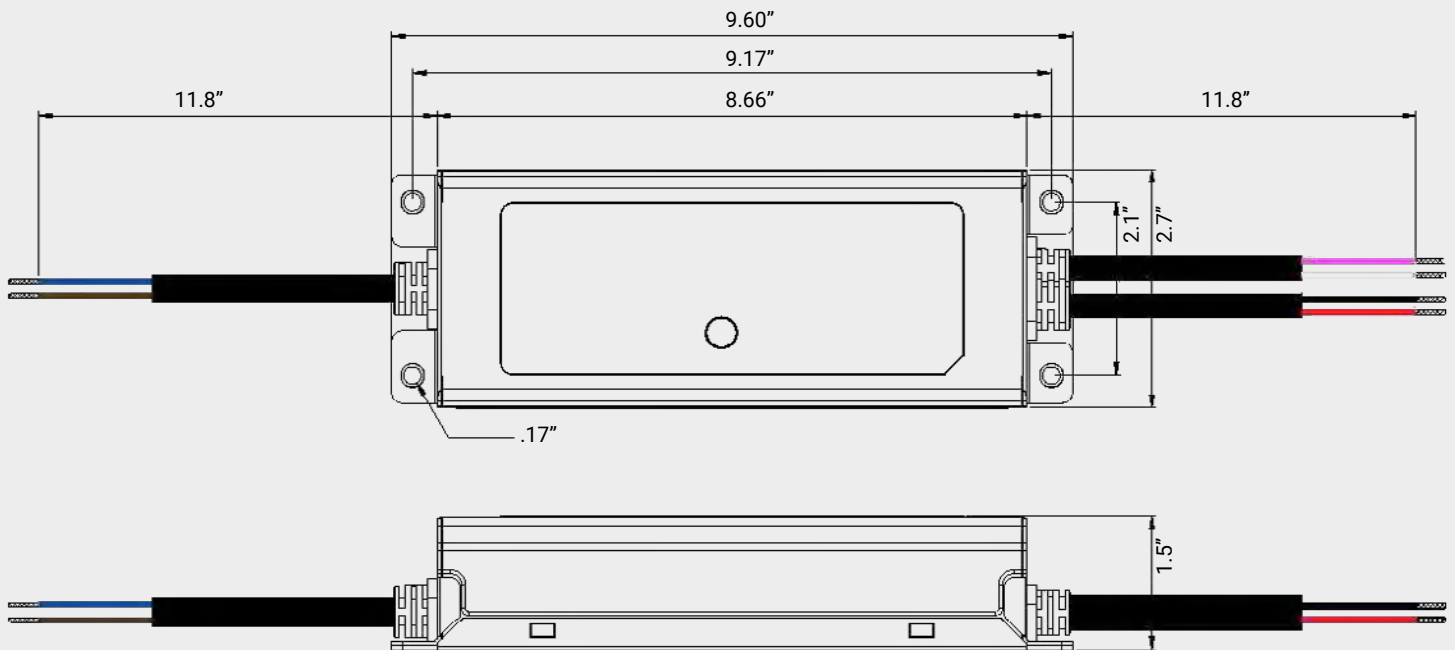

DRIVER: FG-DR-320W-48V

Unit: Inches

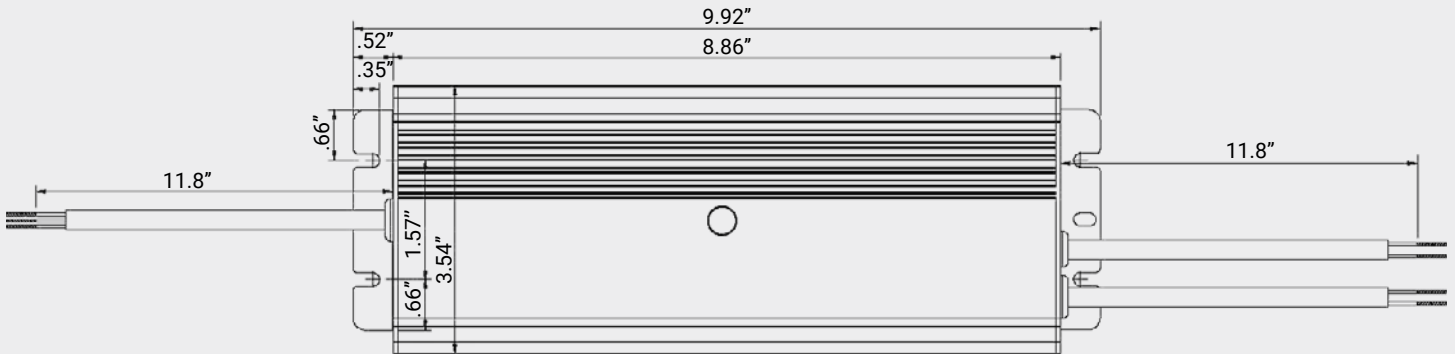

DRIVER: FG-DR-480W-48V

Unit: Inches

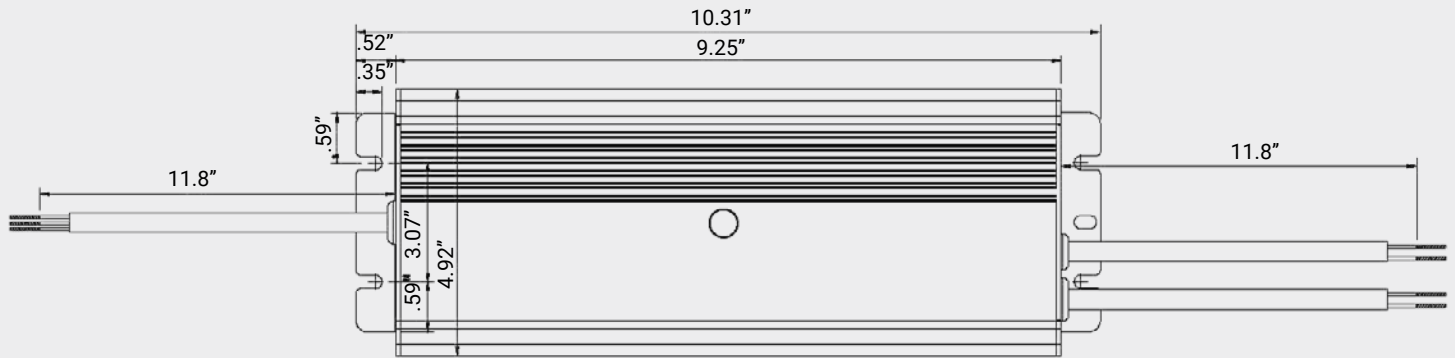

DRIVER BOX DIMENSION

Unit: Inches

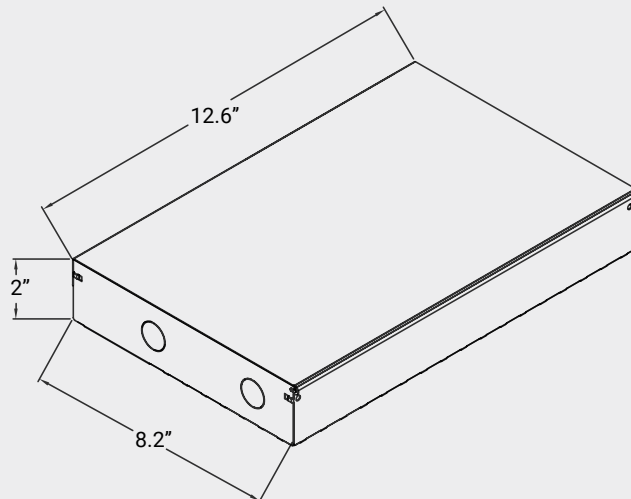

LIGHT MODULE EXAMPLES



Seamless Linear Diffused
Corners

FG-L1R-C90 / CI / C0

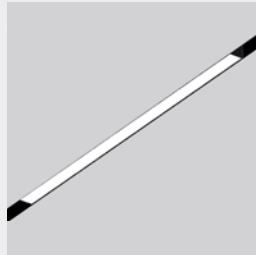

Seamless Linear Diffused

FG-L1R-8 / 16 / 32 / 48 / 64



Linear Downlight

FG-L4R-3 / 5 / 8 / 16 / 32



Linear Louvered

FG-L3R-16 / 32



Wall Wash

FG-L1-WW-3 / 8



Linear Diffused & Adjustable
Light

FG-L2A-3 / 5 / 8



Linear Adjustable Downlight,
Task & Wall Grazer

FG-L4A-3 / 5 / 8



Recessed Track Light

FG-T1-1



Recessed Track Light

FG-T1-2



Cylinder

FG-T2-1 / 2 / 3

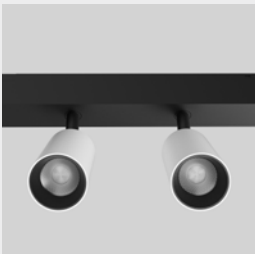

Cylinder

FG-T2-4

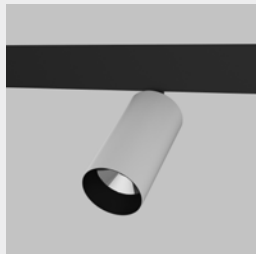

Cylinder

FG-T3-1 / 2 / 3



Beam Adjustable Cylinder

FG-T4-1 / 2 / 3



Projector

FG-TPJ-1



Gobo Projector

FG-TPJ-2



Flat Round

FG-T5-1 / 2



Flat Square

FG-T6-1 / 2



Rectangle Track Light

FG-T7-1

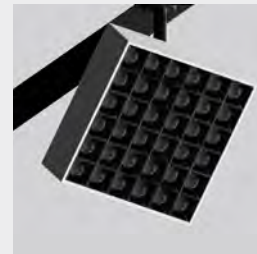

Square Track Light

FG-T7-1 / 3



Line Light

FG-LL-1

LIGHT MODULE EXAMPLES



Wall Light
FG-WL-1



Wall Light
FG-WL-2

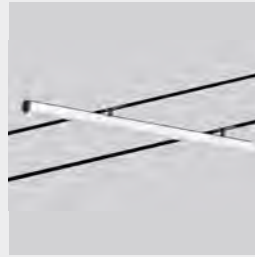

Linear Surface Light
FG-L5S-32 / 48



Linear Surface Light
FG-L2S-32 / 48



Pendant Louvered
FG-L1P-32



Pendant
FG-P1-1 / 2



Pendant
FG-P3-1 / 2



Track Globe
FG-T8-1



Track Globe
FG-T9-1



Track Downlight
FG-T10-1



Pendant Globe
FG-P4-1



Pendant Globe
FG-P4-2

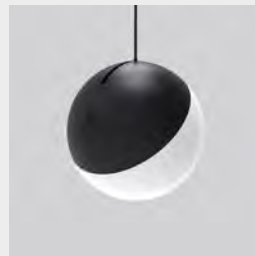

Pendant Globe
FG-P4-3

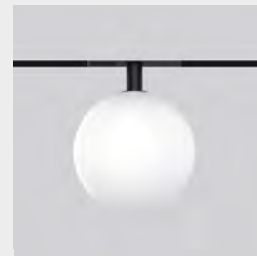

Globe
FG-T11-1



Globe
FG-P5-1

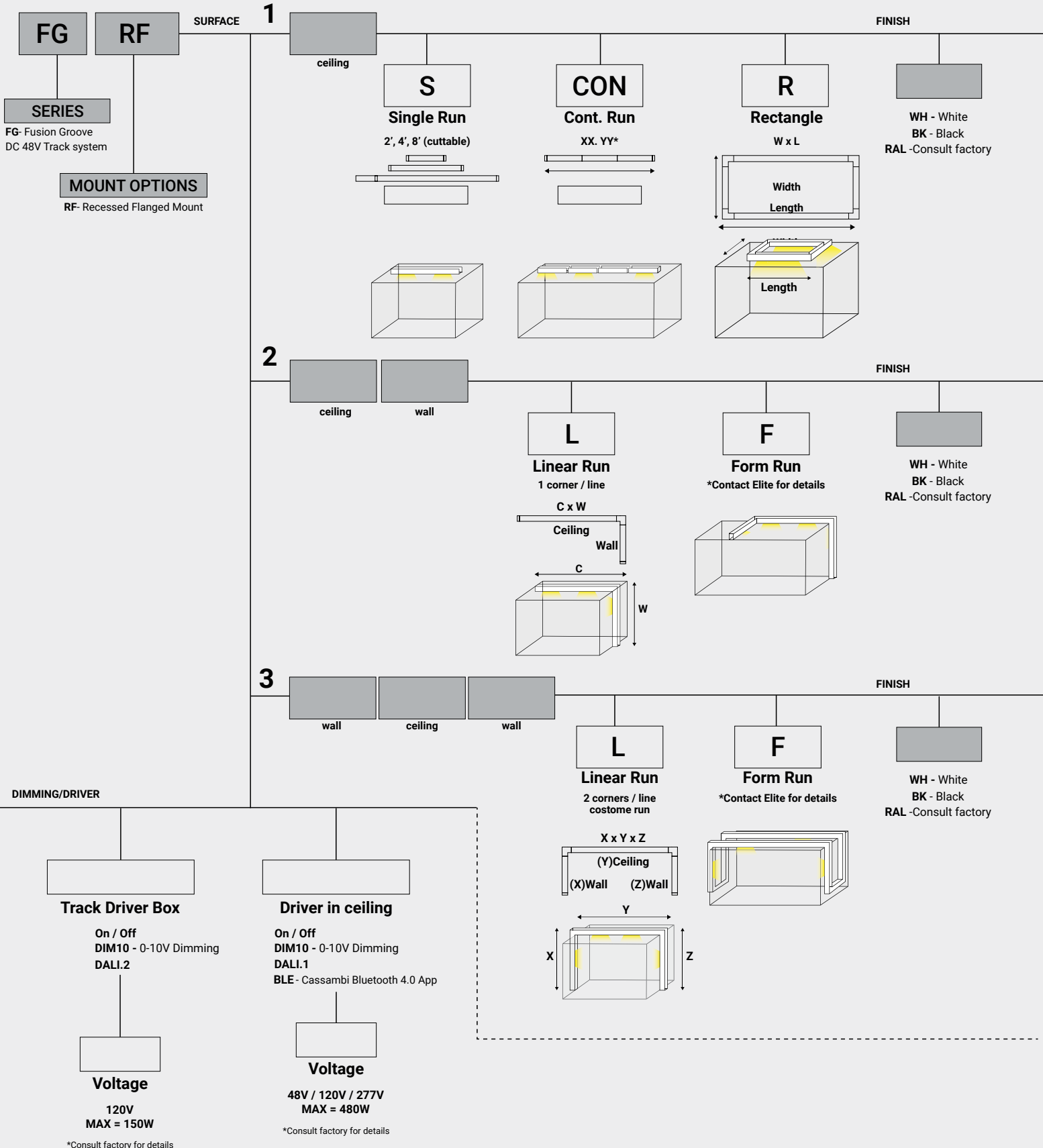

GROOVE RECESSED MOUNT CONFIGURATION EXAMPLES FOR CEILING (1 SURFACE):

● TRACK ○ ENDCAP & CORNERS

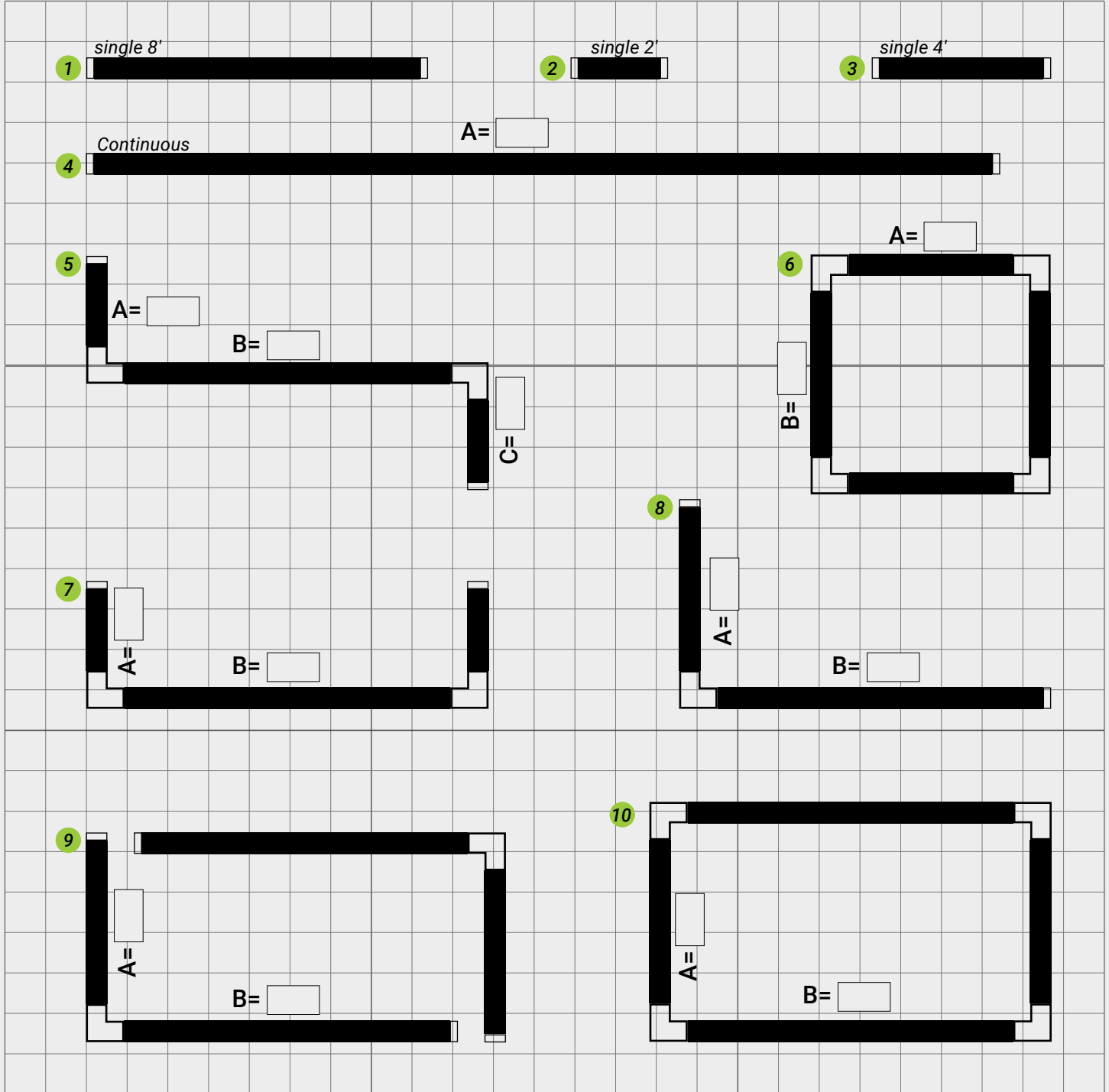

* contact Elite for any custom shape

GROOVE RECESSED MOUNT CONFIGURATION EXAMPLES FOR WALL & CEILING (2 SURFACES):

11 Single Linear Run

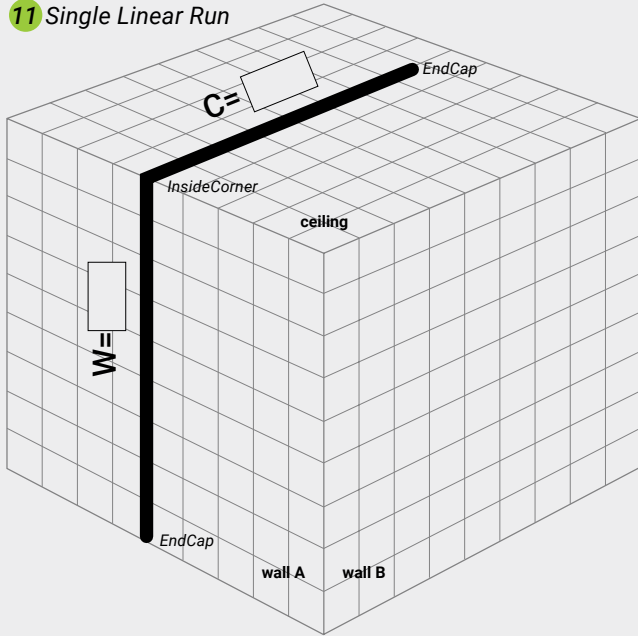

12 Double Linear Run

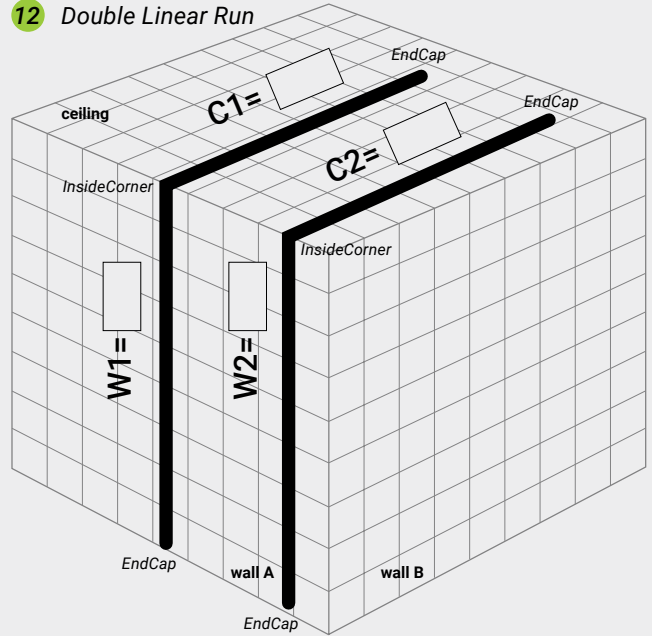

13 Form Run

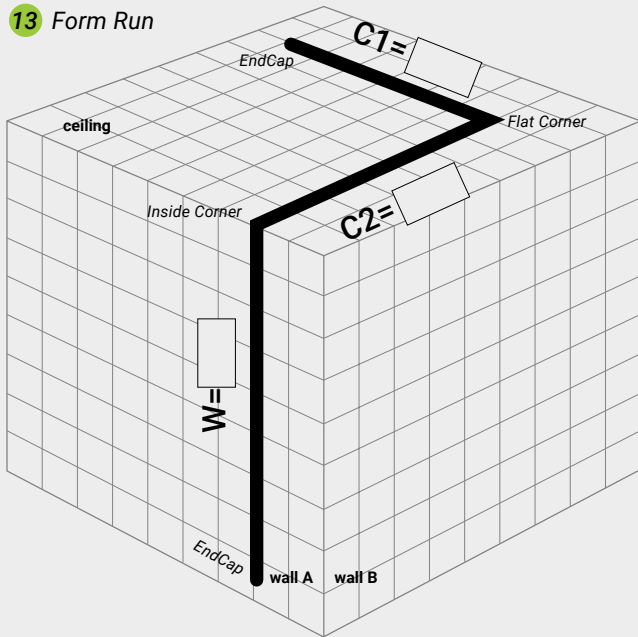

14 Rectangle

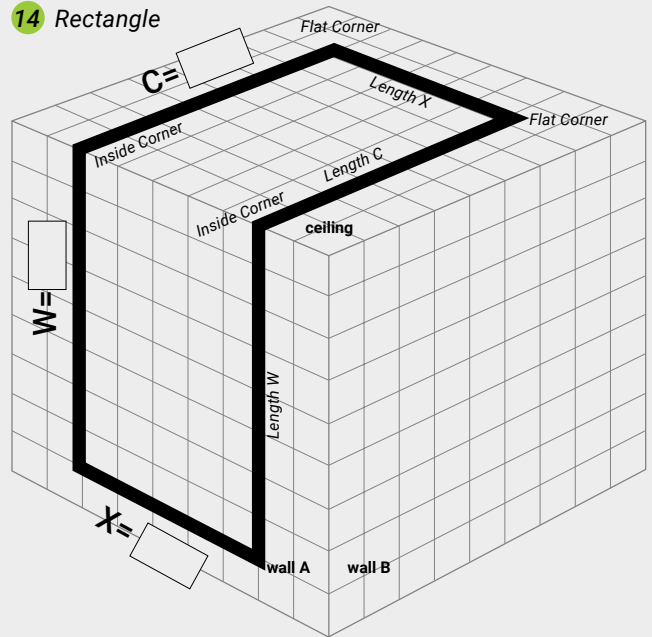

* contact Elite for any custome shape

GROOVE RECESSED MOUNT CONFIGURATION EXAMPLES FOR 3 SURFACES:

12 Single Linear Run

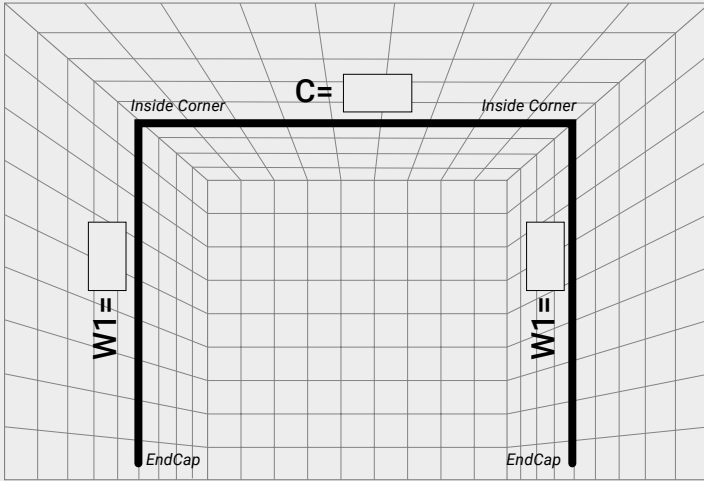

13 Rectangle

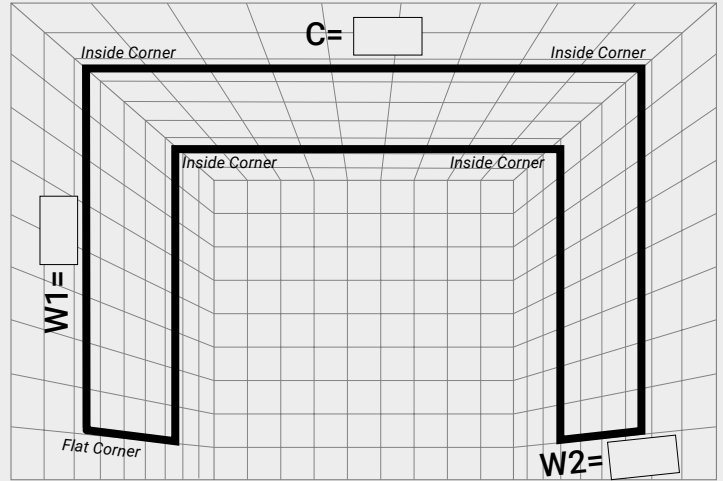

14 Linear Run

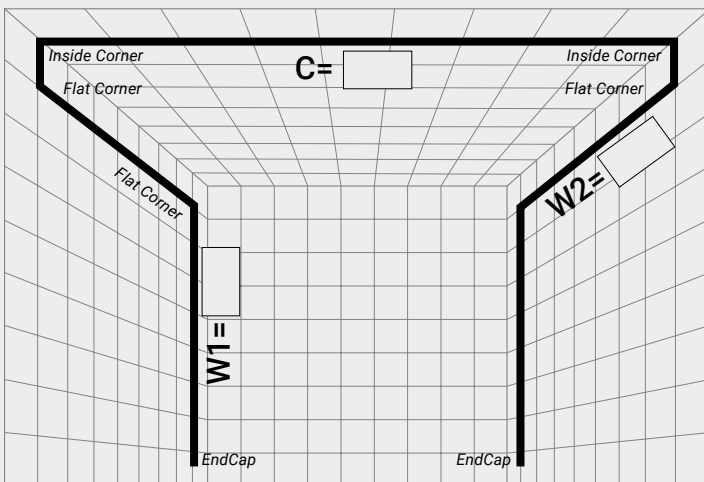

15 Linear Run

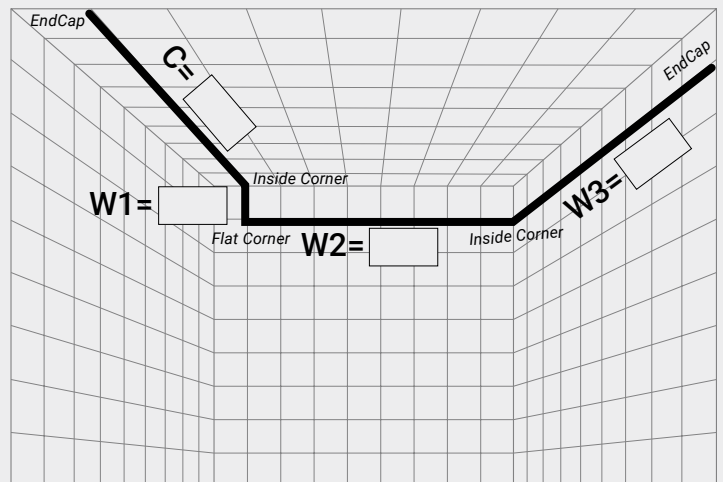

* contact Elite for any custom shape

2 SURFACES DESIGN

● BK - (black) ○ WH - (white)

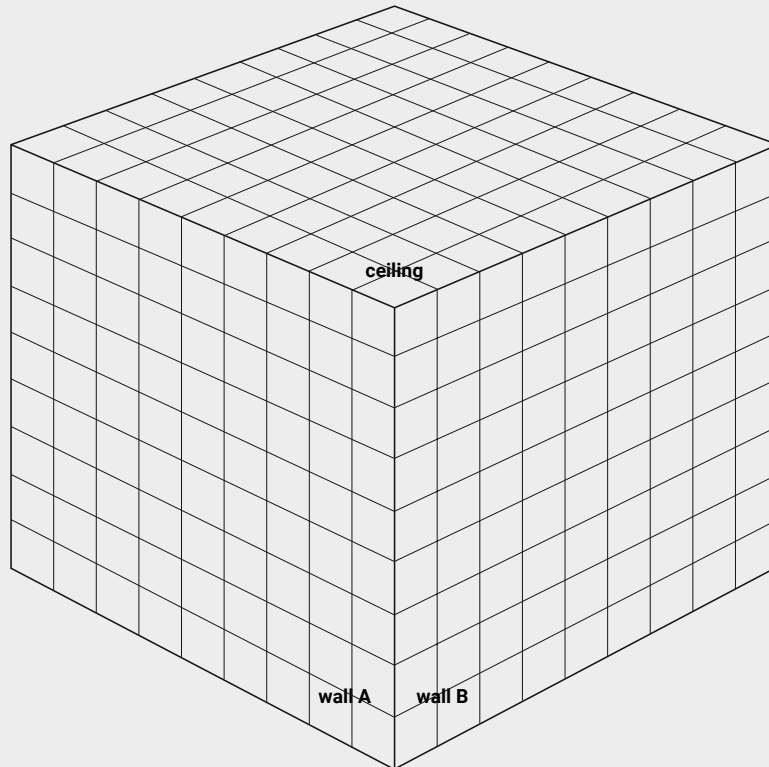
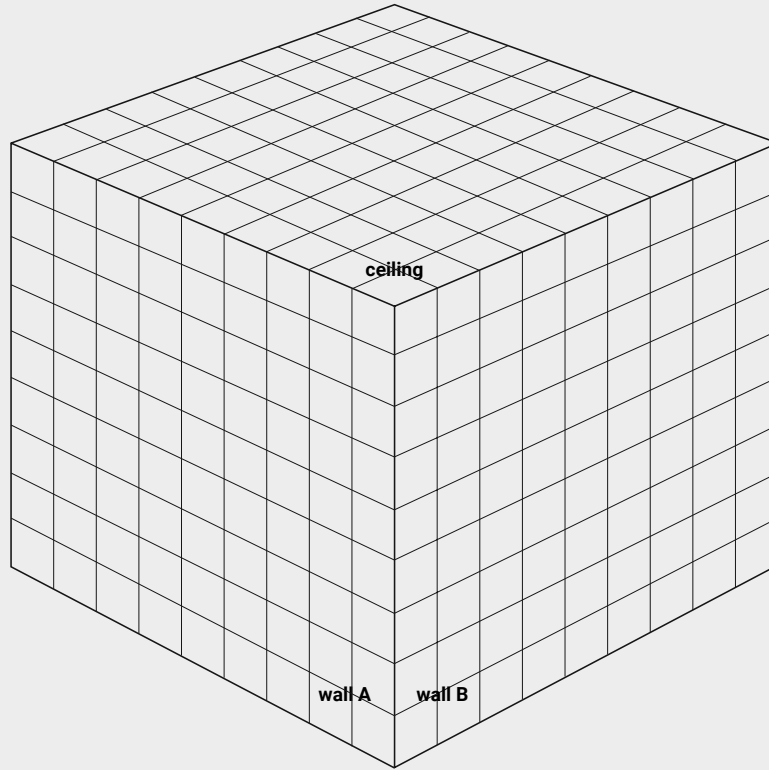

* contact Elite for any custome shape

MULTIPLE SURFACES DESIGN

● BK - (black) ○ WH - (white)

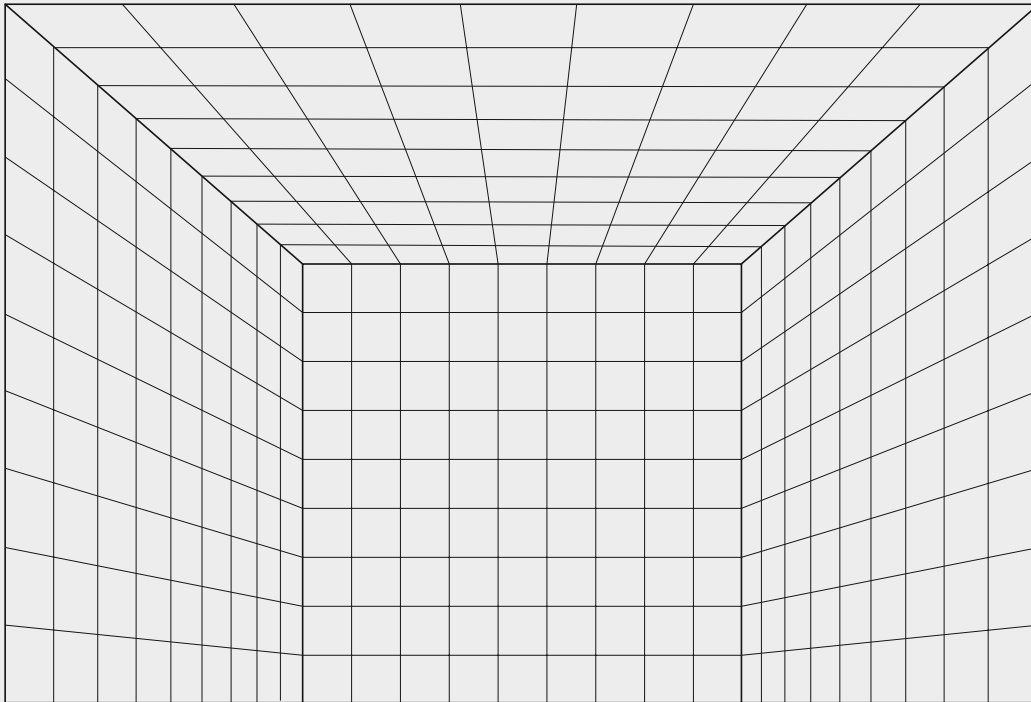
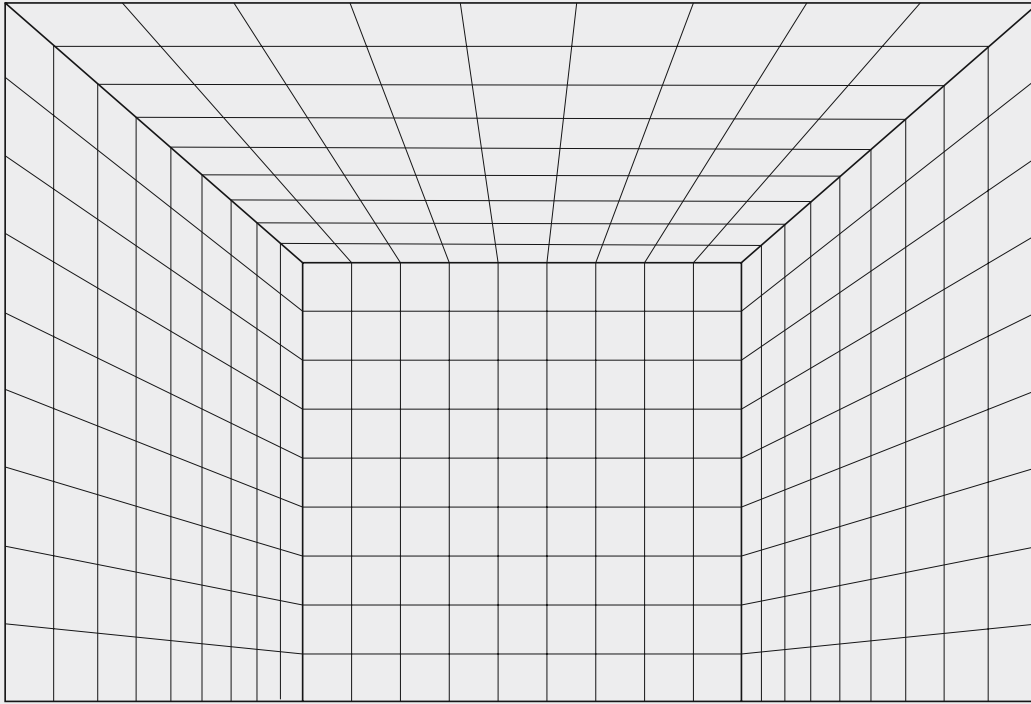

WHAT TO GET SOME SUGGESTIONS?

You are always welcome to contact us: *Elite Lighting Groove Design Team at orders@iuseelite.com.*