

**GROOVE 'SEAMLESS LINEAR DIFFUSED' SERIES**

The 'Seamless Linear Diffused' luminaire easily integrates into the Groove track system and sits flush with the ceiling line or wall for a clean, sophisticated look. Combine with Seamless Linear Diffused Corners to create custom shapes such as squares and rectangles.

Use the FG-L1R with the FG-L1R-C90 to create Flat Corners for squares or rectangles that integrate flush with a ceiling or wall. Combine with the FG-L1-CI for concave Inside Corners and seamlessly transition from a flat, horizontal ceiling to a vertical wall. Utilize the FG-L1R-CO for convex Outside Corners such as the junction between two vertical walls with a 90° angle.

SERIES	DELIVERED LUMENS	WATTAGE
FG-L1R-8	400	8W
FG-L1R-16	800	12W
FG-L1R-32	1400	20W
FG-L1R-48	1800	24W
FG-L1R-64	2500	35W

Based on 4000K, 90+ CRI. Actual wattage may vary +/- 5%

<b>SERIES</b>	Groove - 'Seamless Linear Diffused' series
<b>SIZE</b>	8", 16", 32", 48", 64"
<b>CCT</b>	2700K, 3000K, 3500K, 4000K, 5000K
<b>CRI</b>	90+
<b>COLOR QUALITY</b>	2 Step MacAdam Ellipse
<b>FINISH</b>	● BK (Black)
<b>DIMMING</b>	On / Off, DIM10 - ( 0-10V Dimming), DALI.1 - DALI 2, BLE - Bluetooth
<b>LIFETIME</b>	L70 at 60,000 Hours
<b>PHOTOMETRIC TESTS</b>	In Accordance with IES LM79-08, LM80 and TM-30, TM-21

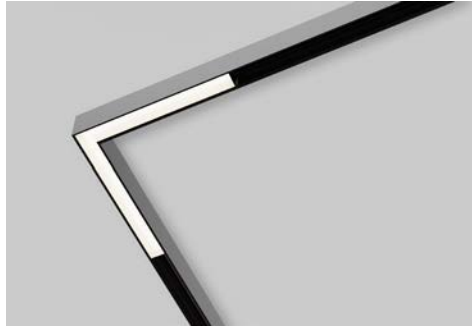
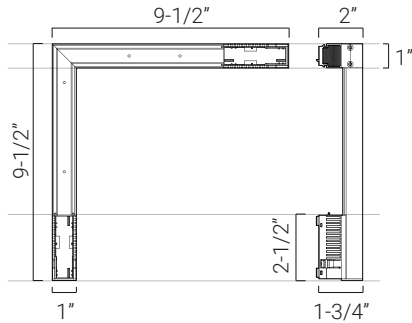
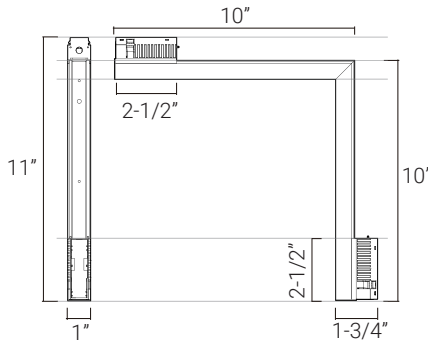
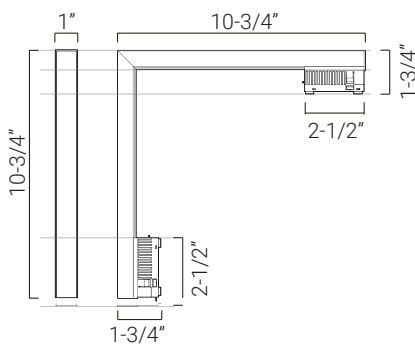

**Flat Corner FG-L1R-C90**

**Inside Corner FG-L1R-CI**

**Outside Corner FG-L1R-CO**

**GROOVE 'SEAMLESS LINEAR DIFFUSED' SERIES**

The 'Seamless Linear Diffused' luminaire easily integrates into the Groove track system and sits flush with the ceiling line or wall for a clean, sophisticated look. Combine with Seamless Linear Diffused Corners to create custom shapes such as squares and rectangles.

Use the FG-L1R with the FG-L1R-C90 to create Flat Corners for squares or rectangles that integrate flush with a ceiling or wall. Combine with the FG-L1-CI for concave Inside Corners and seamlessly transition from a flat, horizontal ceiling to a vertical wall. Utilize the FG-L1R-CO for convex Outside Corners such as the junction between two vertical walls with a 90° angle.

SERIES	DELIVERED LUMENS	WATTAGE
FG-L1R-C90	740	12W
FG-L1R-CI	740	12W
FG-L1R-CO	740	12W

Based on 4000K, 90+ CRI. Actual wattage may vary +/- 5%

<b>SERIES</b>	Groove - 'Seamless Linear Diffused' series
<b>SIZE</b>	Flat Corner, Inside Corner, Outside Corner
<b>CCT</b>	2700K, 3000K, 3500K, 4000K, 5000K
<b>CRI</b>	90+
<b>COLOR QUALITY</b>	2 Step MacAdam Ellipse
<b>FINISH</b>	● BK (Black)
<b>DIMMING</b>	On / Off, DIM10 - (0-10V Dimming), DALI.1 - DALI 2, BLE - Bluetooth
<b>LIFETIME</b>	L70 at 60,000 Hours
<b>PHOTOMETRIC TESTS</b>	In Accordance with IES LM79-08, LM80 and TM-30, TM-21

VWFL: VERY WIDE FLOOD  
Candlepower Distribution Curve

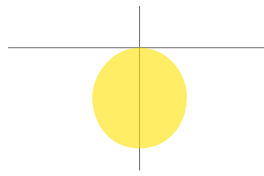

Reference IES files for additional distribution curve information.

### FEATURES OF GROOVE FAMILY

The Groove 48V DC track system is available with multiple sleek, slender, and compact track heads that can be seamlessly mounted onto the track by simply clicking the track head's connector into place, allowing you to interchange one Groove-compatible luminaire for another. The Groove's intuitive click-in track makes it easy to install and switch luminaires, so the system can be updated to match any design or application, current or future.

The Groove track system is available in Trimless Recessed, Recessed Flanged, Ceiling/ Surface, and Suspended options, and can be integrated in most ceiling and wall applications. Utilize suspended and surface mounting options for surface such as wood, drywall or T-Bar ceilings.

The Groove offers a variety of connector accessories that enable users to tailor their designs with custom rectangular, square, or many other linear patterns. The T, X, L Corners and power connectors create dynamic designs that transcend flat surfaces including wall to ceiling, wrap corners, and more.

Drivers can be stowed within the system, hidden from view, or placed in a remote location. The single driver can power runs up to 65' long and 480 Watts. Please refer to driver spec sheets for more detailed information. Our team at Elite Lighting can help you organize the placement of drivers and complete systems.

Fixtures can be installed individually or combined with other Groove track system luminaires to create the perfect design. Multiple linear fixtures can be mounted next to each other on one track for continuous rays of illumination.

Available track head options are in-line linear, adjustable linear, spot, pendant, cylinder, and suspended. Many track heads are crafted with black interiors and TIR optics, providing precise beam control and reducing glare. Most track heads that are available with optics are field-changeable, with various lumen and distribution options. Additionally, some track heads can be overlaid with a single optical accessory, like the Linear Diffuser, Frosted Diffuser, and Honeycomb accessories. Some track heads can be used with spot-light, flood-light, snoot, and wall-wash accessories. (Please refer to the spec sheet on each individual track head for more detailed information.)

Subsequently, the system can be used for accent, task, and general illumination, making it ideal for a plethora of applications, such as galleries, museums, hospitality spaces, retail spaces, corporate offices, and residential spaces.

### CONSTRUCTION

All track heads are engineered to have an extremely long lifespan and service period by using coolLED's Advanced Thermodynamic Design, which includes an extruded aluminum body, a hidden diecast heat sink, and a thermal management system.

### LED MODULE PERFORMANCE

The Groove System's luminaires are equipped with 2-step McAdam Eclipse LEDs, which provide consistent color across all fixtures, and 90+CRI. The LEDs are available in a variety of kelvin temperature options.

### DRIVERS

The Groove System is powered by constant voltage drivers with a rating of 50/60Hz at a 120/277V input and a 48V output. They produce less than 20% THD, have a 90% power factor, and are thermally protected for additional safety. Driver wattages range from 75W to 450W and can power up to 65 ft. of track. Groove drivers can be installed internally within the track or remotely mounted, and are available in 0-10V 1 % Dimming, Dali Dimming, or 120V On/ Off Non-Dimming Driver. Please see Groove track system spec sheets for a complete list of drivers and capabilities.

### DIMMING INFORMATION

DIM10 - 0-10V dimming on either MVOLT 120, 277. Dimmable down to 1% of initial lumens, standard. Available in 75W, 100W, 150W., 240W.  
DIMTR - Electronic low voltage dimming. Available in 120V.  
DALI - DALI DT6 dimming down to 1% Available in 75W, 100W, 150W, 240W.

EldoLED PowerDrive dimming down to 0.1%. Please see the EldoLED website for wiring diagrams and a full list of compatible DMX and DALI control systems.

### FINISH

Luminaires are available in a powder-coated black or white post-paint finish. They may also be issued in custom RAL colors upon request. Consult the factory to find out which custom colors can be accommodated.

### WARRANTY

Five-year warranty for parts and components.

**GROOVE 'SEAMLESS LINEAR DIFFUSED' LINEAR LIGHTS**

EXAMPLE:				
SERIES	CCT	CRI	FINISH	OPTION
FG-L1R-8 8"	<input type="checkbox"/> 27K <input type="checkbox"/> 30K <input type="checkbox"/> 35K <input type="checkbox"/> 40K <input type="checkbox"/> 50K	<input type="checkbox"/> 90	<input type="checkbox"/> BK (Black)	<input type="checkbox"/> 48V <input type="checkbox"/> 48V-BLE (Bluetooth) *Power supply must be ordered seperately
FG-L1R-16 16"				
FG-L1R-32 32"				
FG-L1R-48 48"				
FG-L1R-64 64"				

**GROOVE 'SEAMLESS LINEAR DIFFUSED' CORNERS**

EXAMPLE:				
SERIES	CCT	CRI	FINISH	OPTION
FG-L1R-C90	<input type="checkbox"/> 27K <input type="checkbox"/> 30K <input type="checkbox"/> 35K <input type="checkbox"/> 40K <input type="checkbox"/> 50K	<input type="checkbox"/> 90	<input type="checkbox"/> BK (Black)	<input type="checkbox"/> 48V <input type="checkbox"/> 48V-BLE (Bluetooth) *Power supply must be ordered seperately
FG-L1R-CI				
FG-L1R-CO				

**FG-L1R-8-40K-90**

TEST NO.: **220091**

INPUT WATTS: **8.4**      LUMENS: **411**      EFFICACY: **49**      BEAM ANGLE: **106**      SPACING CRITERIA: **1.14**

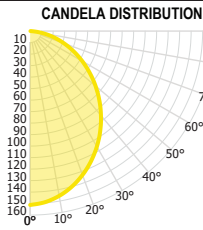

	0°	90°
0°	151	151
10°	146	149
20°	133	139
30°	116	124
40°	96	105
50°	74	83
60°	52	61
70°	32	39
80°	12	19
90°	0	1

	0.00°	90.00°
0.00°	406849	406849
45.00°	323782	358870
55.00°	296320	339764
65.00°	265902	319198
75.00°	225930	297046
85.00°	106520	291465

ZONE	LUMENS
0° - 10°	14
10° - 20°	41
20° - 30°	60
30° - 40°	71
40° - 50°	72
50° - 60°	64
60° - 70°	49
70° - 80°	30
80° - 90°	9

ZONE	UMENS	% LUMINAIRE
0° - 20°	55	13%
0° - 30°	115	28%
0° - 40°	186	45%
0° - 60°	323	78%
0° - 80°	402	98%
0° - 90°	411	100%

**CONE OF LIGHT**

MOUNTING HEIGHT	FC AT BEAM CENTER	BEAM DIA. 0°-180°	BEAM DIA. 90°-270°
6.0 ft	4.2 fc	16.2 ft	16.0 ft
8.0 ft	2.4 fc	21.6 ft	21.4 ft
10.0 ft	1.5 fc	27.0 ft	26.7 ft
12.0 ft	1.0 fc	32.4 ft	32.0 ft
14.0 ft	0.8 fc	37.8 ft	37.4 ft
16.0 ft	0.6 fc	43.2 ft	42.7 ft
18.0 ft	0.5 fc	48.6 ft	48.0 ft
20.0 ft	0.4 fc	53.9 ft	53.4 ft

**INDOOR COEFFICIENTS OF UTILIZATION**

pf	pc	20%																0%			
		80%				70%				50%				30%							
pw	70%	50%	30%	10%	70%	50%	30%	10%	50%	30%	10%	50%	30%	10%	50%	30%	10%	50%	30%	10%	0%
0	119	119	119	119	116	116	116	116	111	111	111	106	106	106	102	102	102	102	100	100	0%
1	109	104	99	95	106	101	97	94	97	94	91	93	91	88	90	87	85	83	83	83	0%
2	99	90	83	78	96	88	82	77	85	80	75	82	77	73	79	75	72	69	69	69	0%
3	90	79	71	65	87	78	70	64	75	68	63	72	66	62	69	65	61	58	58	58	0%
4	82	70	61	55	80	69	61	54	66	59	54	64	58	53	62	57	52	50	50	50	0%
5	76	63	54	47	74	62	53	47	60	52	46	58	51	46	56	50	45	43	43	43	0%
6	70	57	48	41	68	56	47	41	54	46	41	52	45	40	51	45	40	38	38	38	0%
7	65	51	43	36	63	51	42	36	49	42	36	48	41	36	46	40	36	34	34	34	0%
8	61	47	38	33	59	46	38	32	45	38	32	44	37	32	43	36	32	30	30	30	0%
9	57	43	35	29	55	43	35	29	41	34	29	40	34	29	39	33	29	27	27	27	0%
10	53	40	32	27	52	39	32	27	38	31	26	37	31	26	37	31	26	24	24	24	0%

**FG-L1R-16-40K-90**

TEST NO.: **220062**

INPUT WATTS: **12.0**      LUMENS: **737**      EFFICACY: **61**      BEAM ANGLE: **106**      SPACING CRITERIA: **1.19**

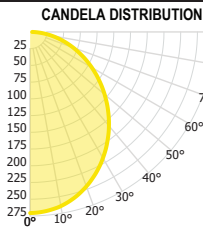

	0°	90°
0°	271	271
10°	264	265
20°	246	247
30°	218	220
40°	183	186
50°	145	148
60°	106	108
70°	68	69
80°	33	33
90°	3	0

	0.00°	90.00°
0.00°	364224	364224
45.00°	312955	318473
55.00°	294983	301270
65.00°	277555	281980
75.00°	261696	261384
85.00°	252407	249628

ZONE	LUMENS
0° - 10°	26
10° - 20°	73
20° - 30°	108
30° - 40°	127
40° - 50°	129
50° - 60°	115
60° - 70°	88
70° - 80°	54
80° - 90°	18

ZONE	UMENS	% LUMINAIRE
0° - 20°	98	13%
0° - 30°	206	28%
0° - 40°	334	45%
0° - 60°	577	78%
0° - 80°	719	98%
0° - 90°	737	100%

**CONE OF LIGHT**

MOUNTING HEIGHT	FC AT BEAM CENTER	BEAM DIA. 0°-180°	BEAM DIA. 90°-270°
6.0 ft	7.5 fc	15.9 ft	16.1 ft
8.0 ft	4.2 fc	21.2 ft	21.4 ft
10.0 ft	2.7 fc	26.5 ft	26.8 ft
12.0 ft	1.9 fc	31.8 ft	32.1 ft
14.0 ft	1.4 fc	37.1 ft	37.5 ft
16.0 ft	1.1 fc	42.4 ft	42.8 ft
18.0 ft	0.8 fc	47.7 ft	48.2 ft
20.0 ft	0.7 fc	53.0 ft	53.5 ft

**INDOOR COEFFICIENTS OF UTILIZATION**

pf	pc	20%																0%			
		80%				70%				50%				30%							
pw	70%	50%	30%	10%	70%	50%	30%	10%	50%	30%	10%	50%	30%	10%	50%	30%	10%	50%	30%	10%	0%
0	119	119	119	119	116	116	116	116	111	111	111	106	106	106	102	102	102	102	100	100	0%
1	108	104	99	95	106	101	97	94	97	94	91	93	90	88	90	87	85	83	83	83	0%
2	99	90	83	78	96	88	82	77	85	79	75	81	77	73	78	75	71	69	69	69	0%
3	90	79	71	64	87	78	70	64	75	68	63	72	66	62	69	65	61	58	58	58	0%
4	82	70	61	55	80	69	61	54	66	59	54	64	58	53	62	57	52	50	50	50	0%
5	76	63	54	47	74	62	53	47	60	52	46	58	51	46	56	50	45	43	43	43	0%
6	70	57	48	41	68	56	47	41	54	46	41	52	45	40	51	45	40	38	38	38	0%
7	65	51	43	36	63	51	42	36	49	42	36	48	41	36	46	40	36	34	34	34	0%
8	61	47	38	33	59	46	38	32	45	38	32	44	37	32	43	36	32	30	30	30	0%
9	57	43	35	29	55	43	35	29	41	34	29	40	34	29	39	33	29	27	27	27	0%
10	53	40	32	27	52	39	32	27	38	31	26	37	31	26	37	31	26	24	24	24	0%

**FG-L1R-32-40K-90**

TEST NO.: 220062

INPUT WATTS: 20.3      LUMENS: 1361      EFFICACY: 67      BEAM ANGLE: 107      SPACING CRITERIA: 1.21 x 1.21

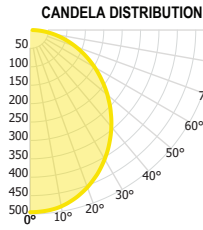

CANDELA TABLE

	0°	90°
0°	495	495
10°	487	485
20°	455	453
30°	405	405
40°	343	343
50°	274	274
60°	202	201
70°	131	128
80°	65	60
90°	7	1

LUMINANCE (cd/sq.m)

	0.00°	90.00°
0.00°	341526	341526
45.00°	301766	302205
55.00°	286102	286367
65.00°	271839	268231
75.00°	259502	247585
85.00°	267667	232754

LUMENS PER ZONE

ZONE	LUMENS
0° - 10°	47
10° - 20°	133
20° - 30°	198
30° - 40°	235
40° - 50°	239
50° - 60°	213
60° - 70°	164
70° - 80°	100
80° - 90°	34

ZONAL LUMEN SUMMARY

ZONE	UMENS	% LUMINAIRE
0° - 20°	180	13%
0° - 30°	378	28%
0° - 40°	613	45%
0° - 60°	1064	78%
0° - 80°	1328	98%
0° - 90°	1361	100%

CONE OF LIGHT

MOUNTING HEIGHT	FC AT BEAM CENTER	BEAM DIA. 0°-180°	BEAM DIA. 90°-270°
6.0 ft	13.7 fc	16.2 ft	16.3 ft
8.0 ft	7.7 fc	21.7 ft	21.7 ft
10.0 ft	4.9 fc	27.1 ft	27.1 ft
12.0 ft	3.4 fc	32.5 ft	32.6 ft
14.0 ft	2.5 fc	37.9 ft	38.0 ft
16.0 ft	1.9 fc	43.3 ft	43.4 ft
18.0 ft	1.5 fc	48.7 ft	48.8 ft
20.0 ft	1.2 fc	54.2 ft	54.3 ft

INDOOR COEFFICIENTS OF UTILIZATION

pw	20%												0%					
	80%			70%			50%			30%			10%		0%			
0	10	20	30	40	50	60	70	80	90	100	110	120	130	140	150	160	170	180
1	108	104	99	95	106	101	97	94	97	94	91	93	90	88	89	87	85	83
2	99	90	83	77	96	88	82	76	85	79	75	81	77	73	78	75	71	69
3	90	79	71	64	87	78	70	64	75	68	63	72	66	62	69	65	60	58
4	82	70	61	55	80	69	61	54	66	59	53	64	58	53	62	56	52	50
5	76	63	54	47	74	62	53	47	59	52	46	57	51	46	56	50	45	43
6	70	57	48	41	68	56	47	41	54	46	41	52	45	40	50	44	40	38
7	65	51	42	36	63	50	42	36	49	41	36	47	41	36	46	40	35	33
8	60	47	38	32	59	46	38	32	45	37	32	44	37	32	42	36	32	30
9	56	43	35	29	55	42	35	29	41	34	29	40	34	29	39	33	29	27
10	53	40	32	27	52	39	32	26	38	31	26	37	31	26	36	30	26	24

**FG-L1R-48-40K-90**

TEST NO.: 220062

INPUT WATTS: 24.5      LUMENS: 1784      EFFICACY: 73      BEAM ANGLE: 106      SPACING CRITERIA: 1.21

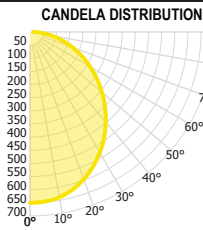

CANDELA TABLE

	0°	90°
0°	650	650
10°	639	635
20°	596	593
30°	530	528
40°	447	447
50°	356	357
60°	263	262
70°	172	167
80°	86	79
90°	12	2

LUMINANCE (cd/sq.m)

	0.00°	90.00°
0.00°	291509	291509
45.00°	255357	255744
55.00°	242023	242164
65.00°	229927	227178
75.00°	221858	211253
85.00°	237227	202543

LUMENS PER ZONE

ZONE	LUMENS
0° - 10°	62
10° - 20°	174
20° - 30°	260
30° - 40°	307
40° - 50°	312
50° - 60°	278
60° - 70°	214
70° - 80°	132
80° - 90°	46

ZONAL LUMEN SUMMARY

ZONE	UMENS	% LUMINAIRE
0° - 20°	236	13%
0° - 30°	496	28%
0° - 40°	803	45%
0° - 60°	1393	78%
0° - 80°	1738	97%
0° - 90°	1784	100%

CONE OF LIGHT

MOUNTING HEIGHT	FC AT BEAM CENTER	BEAM DIA. 0°-180°	BEAM DIA. 90°-270°
6.0 ft	18.1 fc	16.0 ft	16.3 ft
8.0 ft	10.2 fc	21.4 ft	21.7 ft
10.0 ft	6.5 fc	26.7 ft	27.1 ft
12.0 ft	4.5 fc	32.1 ft	32.6 ft
14.0 ft	3.3 fc	37.4 ft	38.0 ft
16.0 ft	2.5 fc	42.8 ft	43.4 ft
18.0 ft	2.0 fc	48.1 ft	48.8 ft
20.0 ft	1.6 fc	53.5 ft	54.3 ft

INDOOR COEFFICIENTS OF UTILIZATION

pw	20%												0%					
	80%			70%			50%			30%			10%		0%			
0	10	20	30	40	50	60	70	80	90	100	110	120	130	140	150	160	170	180
1	108	104	99	95	106	101	97	94	97	94	91	93	90	88	89	87	85	83
2	99	90	83	77	96	88	82	76	85	79	75	81	77	73	78	75	71	69
3	90	79	71	64	87	78	70	64	75	68	63	72	66	62	69	65	60	58
4	82	70	61	55	80	69	61	54	66	59	53	64	58	53	62	56	52	50
5	76	63	54	47	74	62	53	47	59	52	46	57	51	46	56	50	45	43
6	70	57	48	41	68	56	47	41	54	46	41	52	45	40	50	44	40	38
7	65	51	42	36	63	50	42	36	49	41	36	47	41	36	46	40	35	33
8	60	47	38	32	59	46	38	32	45	37	32	44	37	32	42	36	32	30
9	56	43	35	29	55	42	35	29	41	34	29	40	34	29	39	33	29	27
10	53	40	32	27	52	39	32	26	38	31	26	37	31	26	36	30	26	24

**FG-L1R-64-40K-90**

TEST NO.: 220062

INPUT WATTS: 34.7      LUMENS: 2474      EFFICACY: 71      BEAM ANGLE: 107      SPACING CRITERIA: 1.21 x 1.21

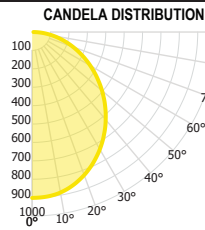

	0°	90°
0°	902	902
10°	886	884
20°	827	827
30°	736	739
40°	622	627
50°	496	501
60°	365	368
70°	236	234
80°	116	110
90°	7	2

	0.00°	90.00°
0.00°	303270	303270
45.00°	266317	268924
55.00°	252213	256148
65.00°	238515	239143
75.00°	227411	221537
85.00°	230524	208564

ZONE	LUMENS
0° - 10°	85
10° - 20°	242
20° - 30°	361
30° - 40°	426
40° - 50°	433
50° - 60°	386
60° - 70°	296
70° - 80°	182
80° - 90°	62

ZONE	UMENS	% LUMINAIRE
0° - 20°	328	13%
0° - 30°	689	28%
0° - 40°	1115	45%
0° - 60°	1934	78%
0° - 80°	2412	98%
0° - 90°	2474	100%

CONE OF LIGHT

MOUNTING HEIGHT	FC AT BEAM CENTER	BEAM DIA. 0°-180°	BEAM DIA. 90°-270°
6.0 ft	25.0 fc	16.1 ft	16.2 ft
8.0 ft	14.1 fc	21.5 ft	21.6 ft
10.0 ft	9.0 fc	26.9 ft	27.0 ft
12.0 ft	6.3 fc	32.3 ft	32.4 ft
14.0 ft	4.6 fc	37.6 ft	37.8 ft
16.0 ft	3.5 fc	43.0 ft	43.2 ft
18.0 ft	2.8 fc	48.4 ft	48.6 ft
20.0 ft	2.3 fc	53.8 ft	54.1 ft

INDOOR COEFFICIENTS OF UTILIZATION

pf	pc	20%												0%					
		80%			70%			50%			30%				10%				
pw	70%	50%	30%	10%	70%	50%	30%	10%	50%	30%	10%	50%	30%	10%	50%	30%	10%	0%	
0	83	83	83	83	81	81	81	81	77	77	77	74	74	74	71	71	71	69	0%
1	75	72	69	66	73	70	67	65	67	65	63	65	63	61	62	61	59	58	0%
2	68	63	58	54	67	61	57	53	59	55	52	56	53	51	54	52	49	48	0%
3	62	55	49	45	61	54	49	44	52	47	43	50	46	43	48	45	42	40	0%
4	57	49	43	38	55	48	42	38	46	41	37	44	40	37	43	39	36	35	0%
5	53	44	37	33	51	43	37	32	41	36	32	40	35	32	39	35	31	30	0%
6	49	39	33	29	47	39	33	28	37	32	28	36	31	28	35	31	28	26	0%
7	45	36	29	25	44	35	29	25	34	29	25	33	28	25	32	28	25	23	0%
8	42	33	27	23	41	32	26	22	31	26	22	30	26	22	29	25	22	21	0%
9	39	30	24	20	38	29	24	20	29	24	20	28	23	20	27	23	20	19	0%
10	37	28	22	18	36	27	22	18	27	22	18	26	21	18	25	21	18	17	0%

**FG-L1R-C90-40K-90**

TEST NO.: 220062

INPUT WATTS: 12.0      LUMENS: 737      EFFICACY: 61      BEAM ANGLE: 106      SPACING CRITERIA: 1.19

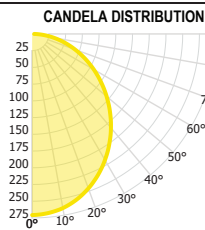

	0°	90°
0°	271	271
10°	264	265
20°	246	247
30°	218	220
40°	183	186
50°	145	148
60°	106	108
70°	68	69
80°	33	33
90°	3	0

	0.00°	90.00°
0.00°	364224	364224
45.00°	312955	318473
55.00°	294983	301270
65.00°	277555	281980
75.00°	261696	261384
85.00°	252407	249628

ZONE	LUMENS
0° - 10°	26
10° - 20°	73
20° - 30°	108
30° - 40°	127
40° - 50°	129
50° - 60°	115
60° - 70°	88
70° - 80°	54
80° - 90°	18

ZONE	UMENS	% LUMINAIRE
0° - 20°	98	13%
0° - 30°	206	28%
0° - 40°	334	45%
0° - 60°	577	78%
0° - 80°	719	98%
0° - 90°	737	100%

CONE OF LIGHT

MOUNTING HEIGHT	FC AT BEAM CENTER	BEAM DIA. 0°-180°	BEAM DIA. 90°-270°
6.0 ft	7.5 fc	15.9 ft	16.1 ft
8.0 ft	4.2 fc	21.2 ft	21.4 ft
10.0 ft	2.7 fc	26.5 ft	26.8 ft
12.0 ft	1.9 fc	31.8 ft	32.1 ft
14.0 ft	1.4 fc	37.1 ft	37.5 ft
16.0 ft	1.1 fc	42.4 ft	42.8 ft
18.0 ft	0.8 fc	47.7 ft	48.2 ft
20.0 ft	0.7 fc	53.0 ft	53.5 ft

INDOOR COEFFICIENTS OF UTILIZATION

pf	pc	20%												0%					
		80%			70%			50%			30%				10%				
pw	70%	50%	30%	10%	70%	50%	30%	10%	50%	30%	10%	50%	30%	10%	50%	30%	10%	0%	
0	119	119	119	119	116	116	116	116	111	111	111	106	106	106	102	102	102	100	0%
1	108	104	99	95	106	101	97	94	97	94	91	93	90	88	90	87	85	83	0%
2	99	90	83	78	96	88	82	77	85	79	75	81	77	73	78	75	71	69	0%
3	90	79	71	64	87	78	70	64	75	68	63	72	66	62	69	65	61	58	0%
4	82	70	61	55	80	69	61	54	66	59	54	64	58	53	62	57	52	50	0%
5	76	63	54	47	74	62	53	47	60	52	46	58	51	46	56	50	45	43	0%
6	70	57	48	41	68	56	47	41	54	46	41	52	45	40	51	45	40	38	0%
7	65	51	43	36	63	51	42	36	49	42	36	48	41	36	46	40	36	34	0%
8	61	47	38	33	59	46	38	32	45	38	32	44	37	32	43	36	32	30	0%
9	57	43	35	29	55	43	35	29	41	34	29	40	34	29	39	33	29	27	0%
10	53	40	32	27	52	39	32	27	38	31	26	37	31	26	37	31	26	24	0%

**FG-L1R-CI-40K-90**

TEST NO.: 220062

INPUT WATTS: 34.7      LUMENS: 2474      EFFICACY: 71      BEAM ANGLE: 107      SPACING CRITERIA: 1.21 x 1.21

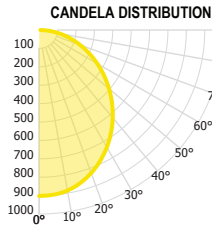

	0°	90°
0°	902	902
10°	886	884
20°	827	827
30°	736	739
40°	622	627
50°	496	501
60°	365	368
70°	236	234
80°	116	110
90°	7	2

	0.00°	90.00°
0.00°	303270	303270
45.00°	266317	268924
55.00°	252213	256148
65.00°	238515	239143
75.00°	227411	221537
85.00°	230524	208564

ZONE	LUMENS
0° - 10°	85
10° - 20°	242
20° - 30°	361
30° - 40°	426
40° - 50°	433
50° - 60°	386
60° - 70°	296
70° - 80°	182
80° - 90°	62

ZONE	UMENS	% LUMINAIRE
0° - 20°	328	13%
0° - 30°	689	28%
0° - 40°	1115	45%
0° - 60°	1934	78%
0° - 80°	2412	98%
0° - 90°	2474	100%

**CONE OF LIGHT**

MOUNTING HEIGHT	FC AT BEAM CENTER	BEAM DIA. 0°-180°	BEAM DIA. 90°-270°
6.0 ft	25.0 fc	16.1 ft	16.2 ft
8.0 ft	14.1 fc	21.5 ft	21.6 ft
10.0 ft	9.0 fc	26.9 ft	27.0 ft
12.0 ft	6.3 fc	32.3 ft	32.4 ft
14.0 ft	4.6 fc	37.6 ft	37.8 ft
16.0 ft	3.5 fc	43.0 ft	43.2 ft
18.0 ft	2.8 fc	48.4 ft	48.6 ft
20.0 ft	2.3 fc	53.8 ft	54.1 ft

**INDOOR COEFFICIENTS OF UTILIZATION**

pf	pc	20%												0%					
		80%			70%			50%			30%				10%				
pw	70%	50%	30%	10%	70%	50%	30%	10%	50%	30%	10%	50%	30%	10%	50%	30%	10%	0%	
0	83	83	83	83	81	81	81	81	77	77	77	74	74	74	71	71	71	69	0%
1	75	72	69	66	73	70	67	65	67	65	63	65	63	61	62	61	59	58	0%
2	68	63	58	54	67	61	57	53	59	55	52	56	53	51	54	52	49	48	0%
3	62	55	49	45	61	54	49	44	52	47	43	50	46	43	48	45	42	40	0%
4	57	49	43	38	55	48	42	38	46	41	37	44	40	37	43	39	36	35	0%
5	53	44	37	33	51	43	37	32	41	36	32	40	35	32	39	35	31	30	0%
6	49	39	33	29	47	39	33	28	37	32	28	36	31	28	35	31	28	26	0%
7	45	36	29	25	44	35	29	25	34	29	25	33	28	25	32	28	25	23	0%
8	42	33	27	23	41	32	26	22	31	26	22	30	26	22	29	25	22	21	0%
9	39	30	24	20	38	29	24	20	29	24	20	28	23	20	27	23	20	19	0%
10	37	28	22	18	36	27	22	18	27	22	18	26	21	18	25	21	18	17	0%

**FG-L1R-CO-40K-90**

TEST NO.: 220062

INPUT WATTS: 12.0      LUMENS: 737      EFFICACY: 61      BEAM ANGLE: 106      SPACING CRITERIA: 1.19

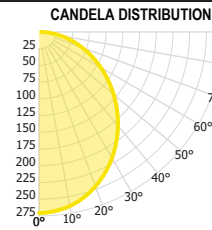

	0°	90°
0°	271	271
10°	264	265
20°	246	247
30°	218	220
40°	183	186
50°	145	148
60°	106	108
70°	68	69
80°	33	33
90°	3	0

	0.00°	90.00°
0.00°	364224	364224
45.00°	312955	318473
55.00°	294983	301270
65.00°	277555	281980
75.00°	261696	261384
85.00°	252407	249628

ZONE	LUMENS
0° - 10°	26
10° - 20°	73
20° - 30°	108
30° - 40°	127
40° - 50°	129
50° - 60°	115
60° - 70°	88
70° - 80°	54
80° - 90°	18

ZONE	UMENS	% LUMINAIRE
0° - 20°	98	13%
0° - 30°	206	28%
0° - 40°	334	45%
0° - 60°	577	78%
0° - 80°	719	98%
0° - 90°	737	100%

**CONE OF LIGHT**

MOUNTING HEIGHT	FC AT BEAM CENTER	BEAM DIA. 0°-180°	BEAM DIA. 90°-270°
6.0 ft	7.5 fc	15.9 ft	16.1 ft
8.0 ft	4.2 fc	21.2 ft	21.4 ft
10.0 ft	2.7 fc	26.5 ft	26.8 ft
12.0 ft	1.9 fc	31.8 ft	32.1 ft
14.0 ft	1.4 fc	37.1 ft	37.5 ft
16.0 ft	1.1 fc	42.4 ft	42.8 ft
18.0 ft	0.8 fc	47.7 ft	48.2 ft
20.0 ft	0.7 fc	53.0 ft	53.5 ft

**INDOOR COEFFICIENTS OF UTILIZATION**

pf	pc	20%												0%					
		80%			70%			50%			30%				10%				
pw	70%	50%	30%	10%	70%	50%	30%	10%	50%	30%	10%	50%	30%	10%	50%	30%	10%	0%	
0	119	119	119	119	116	116	116	116	111	111	111	106	106	106	102	102	102	100	0%
1	108	104	99	95	106	101	97	94	97	94	91	93	90	88	90	87	85	83	0%
2	99	90	83	78	96	88	82	77	85	79	75	81	77	73	78	75	71	69	0%
3	90	79	71	64	87	78	70	64	75	68	63	72	66	62	69	65	61	58	0%
4	82	70	61	55	80	69	61	54	66	59	54	64	58	53	62	57	52	50	0%
5	76	63	54	47	74	62	53	47	60	52	46	58	51	46	56	50	45	43	0%
6	70	57	48	41	68	56	47	41	54	46	41	52	45	40	51	45	40	38	0%
7	65	51	43	36	63	51	42	36	49	42	36	48	41	36	46	40	36	34	0%
8	61	47	38	33	59	46	38	32	45	38	32	44	37	32	43	36	32	30	0%
9	57	43	35	29	55	43	35	29	41	34	29	40	34	29	39	33	29	27	0%
10	53	40	32	27	52	39	32	27	38	31	26	37	31	26	37	31	26	24	0%



**GROOVE TRACK LUMINAIRE OPTIONS:**



FG-L1R-C90  
*Seamless Linear Diffused*



FG-L1R-CI  
*Seamless Linear Diffused*



FG-L1R-CO  
*Seamless Linear Diffused*

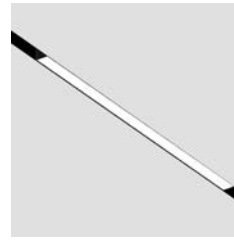

FG-L1R-8 | 16 | 32 | 48 | 64  
*Seamless Linear Diffused*

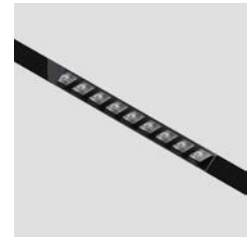

FG-L1-WW-3 | 8  
*Wall Wash*



FG-L3R-16 | 32  
*Linear Louvered*

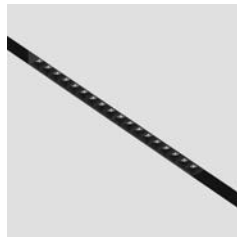

FG-L4R-3 | 5 | 8 | 16 | 32  
*Linear Recessed Downlight & Task*



FG-L2A-3 | 5 | 8  
*Linear Diffused & Adjustable Light*

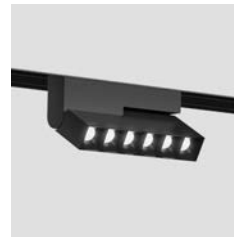

FG-L4A-3 | 5 | 8  
*Linear Adjustable Downlight, Task & Wall Grazer*



FG-T2-1 | 2 | 3 | FG-T3-1 | 2 | 3  
*Cylinder*

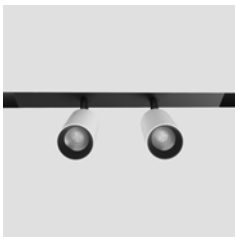

FG-T2-4  
*Cylinder*

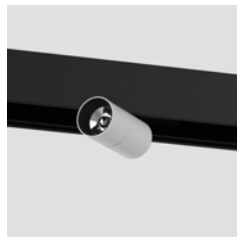

FG-T4-1 | 2 | 3  
*Beam Adjustable Cylinder*

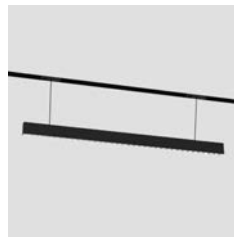

FG-L1P-32  
*Pendant Louvered*



FG-P1-1 | 2  
*Pendant*



FG-P3-1 | 2  
*Pendant*



FG-P4-1 | 2 | 3  
*Pendant Globe*



FG-P5-1  
*Globe*



FG-T1-1  
*Recessed Track Light*



FG-T1-2  
*Recessed Track Light*

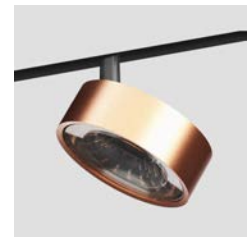

FG-T5-1 | 2  
*Flat Round*



FG-T6-1 | 2  
*Flat Square*

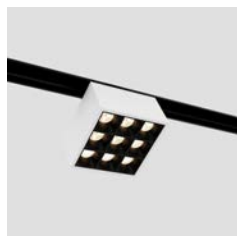

FG-T7-1 | 3  
*Square Track Light*



FG-T7-2  
*Rectangle Track Light*



FG-T8-1  
*Track Globe*



FG-T9-1  
*Track Globe*

**GROOVE TRACK LUMINAIRE OPTIONS:**

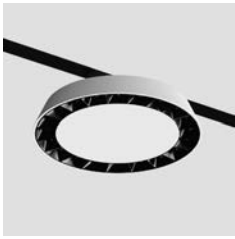

FG-T10-1  
*Track Downlight*

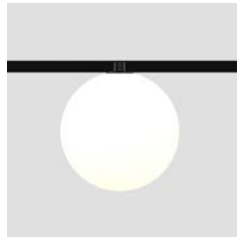

FG-T11-1  
*Globe*

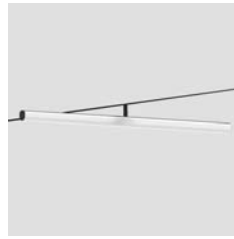

FG-L2S-32 | 48  
*Surface Light*

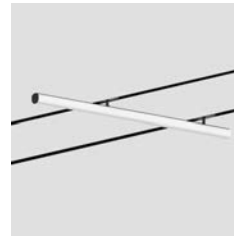

FG-L5S-32 | 48  
*Surface Light*



FG-WL-1  
*Wall Light*

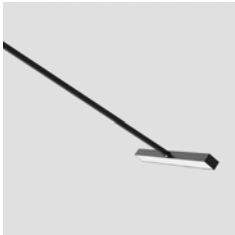

FG-WL-2  
*Wall Light*

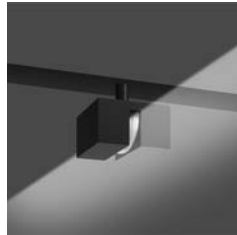

FG-LL-1  
*Line Light*



FG-TRJ-1  
*Projector*



FG-TRJ-2  
*Gobo Projector*

**GROOVE TRACK MOUNTING OPTIONS:**



*Trimless Recessed Mount*



*Surface, Ceiling Mount*

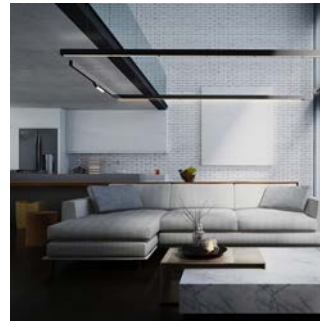

*Suspended Mount with Uplight*



*Suspended Mount*