

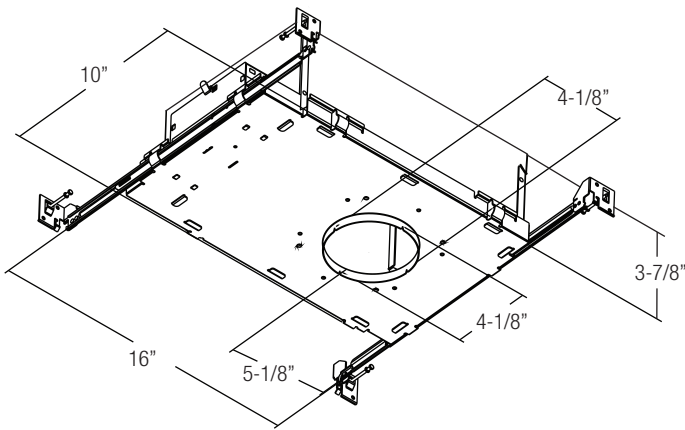

TRIM OPTIONS



NOMINAL LUMENS	DELIVERED LUMENS	WATTAGE
1500	1534	24 W
1200	1203	18 W
900	907	16 W

Based on 4000K, 90+ CRI. Actual wattage may vary +/- 5%

FEATURES

A small aperture, architectural LED downlight that delivers the ultimate in uncompromised quality and performance, with precise, glare-free illumination, and unmatched flexibility. With the use of a single universal housing, it utilizes a multitude of trims, field changeable optics, and is fully adjustable to any beam angle, up to 45 degrees, with a full 365-degree horizontal rotation. Whether it's high-end architectural, hospitality, commercial, residential, or retail, the ER3 provides the most innovative solution to any design application that requires a small aperture.

LUMENS	900, 1200, 1500
WARM DIM PLATFORMS	100% lumen output at 3000K, down to a 1% lumen output at 1800K
CRI	90+ Standard
COLOR QUALITY	2 Step MacAdam Ellipse
DISTRIBUTION PATTERNS	SPD(Sport-15°), ND(Narrow-24°), MD(Medium-35°), MWD(Medium Wide-45°), WD(Wide-52°)
TRIM OPTIONS	Round and Square, Trim and Trimless, with Open Downlight, Lensed Downlight, and Pinhole Downlight
REFLECTOR COLORS	WH (White), CL (Chrome), SHZ (Satin Haze), BK (Black)
FLANGE COLORS	WH (White)
DIMMING	0-10V Flicker Free 1% Dimming Standard (DIM10), LUTH LUT2W, DIMTR, DMX512-DALI
EMERGENCY	10W - Bodine BSL310 - 900L-1000L 20W - Bodine BSL20 - 1800L-2000L
LIFETIME	L70 at 50,000 Hours
PHOTOMETRIC TESTS	In Accordance with IES LM79-08, LM80 and TM-30, TM-21
CCEA OPTION	For CCEA approved ER3 Family, please contact Elite Lighting for more information.

WD: WIDE
Candlepower Distribution Curve

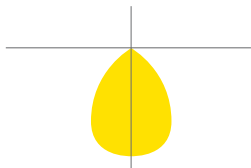

MD: MEDIUM
Candlepower Distribution Curve

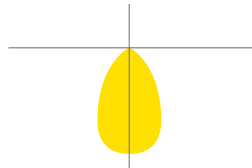

D: D
Candlepower Distribution Curve

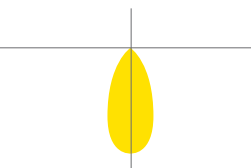

2D: 2%663;
Candlepower Distribution Curve

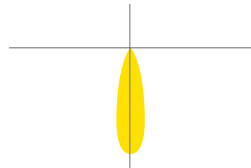

74(, 7438
Candlepower Distribution Curve

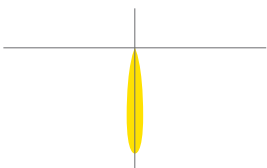

Reference IES files for additional distribution curve information.



FLANGED OPTION

Post-painted powder coated Die-Cast trim ring available in white and custom colors (Please consult factory for custom paint color options). Collar and trim rotate jointly, and a Solite frosted lens is standard on all trims (Please consult factory for additional lens options). Available in Open Downlight, Lensed Downlight, Pinhole Downlight, Slot, Adjustable Downlight Accent or Lensed Adjustable Wall Wash. Trims attach to the housing with piano springs for snug fit and zero light leakage.

TRIM-LESS OPTION

Die-Cast perforated mesh cover intended for installation in drywall or plaster ceilings. Mudding may be applied right up to the edge of the luminaire opening to provide a seamless appearance. Trimless accessory is secured to the housing to prevent fractures in the ceiling and/or drywall during and after installation. Trims attach to the housing with piano springs for snug fit and zero light leakage. Available in Open Downlight, Lensed Downlight, Pinhole Downlight, Slot, Adjustable Downlight Accent or Lensed Adjustable Wall Wash.

HOUSING

Designed for new construction installations and suitable for use in IC and Non IC applications. Thermally protected, specification grade adjustable recessed housing. For new construction insulated ceilings where housing will be in direct contact with insulation. die-formed all aluminum construction is painted matte black for maximum heat dissipation, rust protection and glare-free illumination.

MOUNTING

Pre-installed bar hangers allow housing to be positioned and locked at any point within a 24" joist span. They can be positioned on either the long or short axis of the housing and can be shortened for 12" joists. Bar hangers can fit onto T-Bar spline with additional slots and holes for special mounting methods, if necessary. Butterfly brackets are also provided and are constructed from 18-gauge steel and can be adjusted vertically. Butterfly brackets may be installed with 3/4" or 1-1/2" lathing channel, 1/2" EMT, or optional C-Channel mounting bars are available.

WARRANTY

Five-year warranty for parts and components. (Labor not included.)

LISTINGS

c-UL-us - Listed for Wet Location if used with 1328 or 1307 Trims.
CP - City of Chicago Environmental Air (CCEA) marking for plenum applications (option)

DIMMING & DRIVER INFORMATION

DIM10 - 0-10V dimming on either MVOLT 120, 277 or 347V. Dimmable down to 1% of initial lumens, standard.

DIMTR - Triac & Electronic low voltage dimming. Available in 120V.

LUT2W - Lutron LTEA2W Hi-Lume 1%. 2-wire LED driver (120V forward phase only).

LUTH - Lutron LDE1 Hi-Lume 1% EcoSystem LED driver with Soft-on, Fade-to-Black dimming technology.

ELDO10.1 - EldoLED SoloDrive 0-10V. Dimming down to 0.1%.

DALI - DALI DT6, DT8 dimming down to 1%.

ELDODMX - EldoLED PowerDrive dimming down to 0.1%.

Please see EldoLED website for wiring diagrams and a list of compatible DMX and Dali control systems.

LED DYNAMIC PLATFORM OPTIONS



Dims to Warm with Smart Dim technology simulates traditional incandescent halogen lighting through dimming, while providing the energy efficiency, high performance and longevity of LED luminaires. When the luminaire dims to warm, it makes a smooth transition across the black body radiator curve. Starting with a 100% lumen output at 3000K, down to a 1% lumen output at 1800K, and maintaining a constant CRI of 90+. It results in rich amber tones as the light dims, encouraging relaxation. An ideal source for hospitality, residential, and assisted living applications.

Round Flanged Trim Options

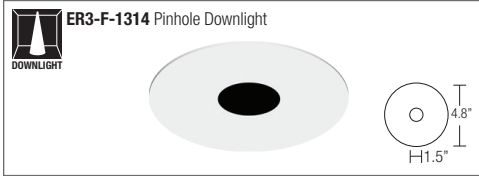
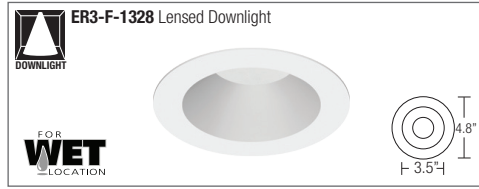
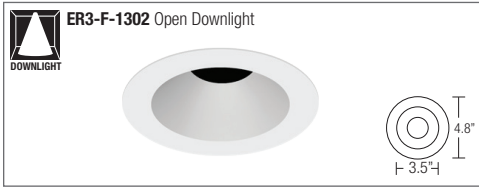

Round Trim-less Options

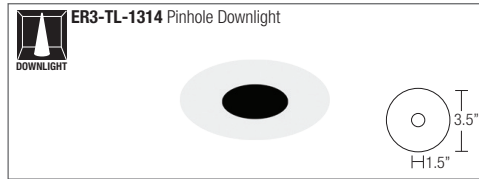
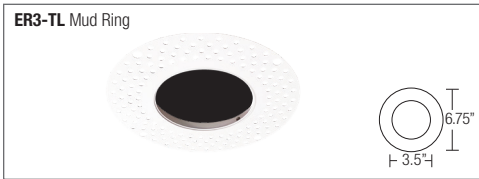
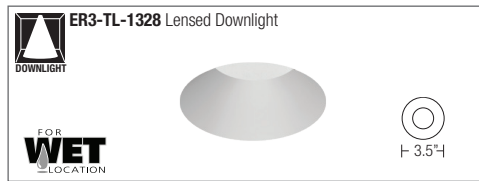
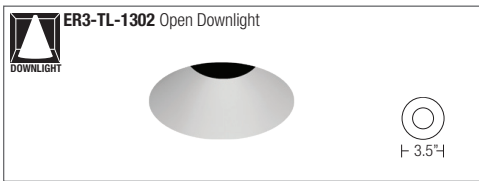

FLANGED OPTION:

Post-painted powder coated Die-Cast trim ring available in white and custom colors (Please consult factory for custom paint color options). Collar and trim rotate jointly, and a Solite frosted lens is standard on all trims (Please consult factory for additional lens options). Available in Open Downlight, Lensed Downlight, Pinhole Downlight, Slot, Adjustable Downlight Accent or Lensed Adjustable Wall Wash. Trims attach to the housing with piano springs for snug fit and zero light leakage.

FINISH



WH-White



CL-Chrome



SHZ-Satin Haze



BK-Black

TRIMLESS OPTION:

Die-Cast perforated mesh cover intended for installation in drywall or plaster ceilings. Mudding may be applied right up to the edge of the luminaire opening to provide a seamless appearance. Trimless accessory is secured to the housing to prevent fractures in the ceiling and/or drywall during and after installation. Trims attach to the housing with piano springs for snug fit and zero light leakage. Available in Open Downlight, Lensed Downlight, Pinhole Downlight, Slot, Adjustable Downlight Accent or Lensed Adjustable Wall Wash.

Note:

Additional lens filters must only be used on open non-lensed downlight trim options.

Square Flanged Trim Options

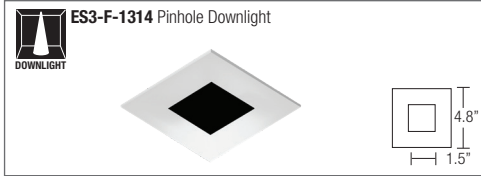
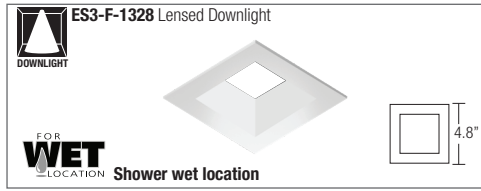
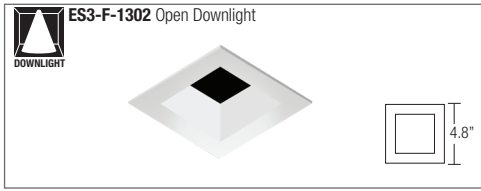

Square Trim-less Options

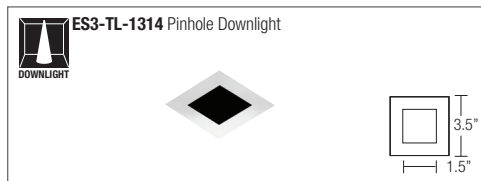
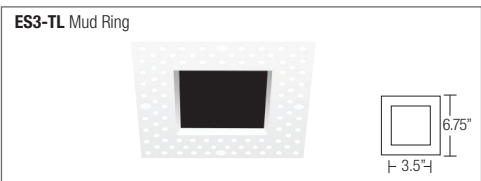
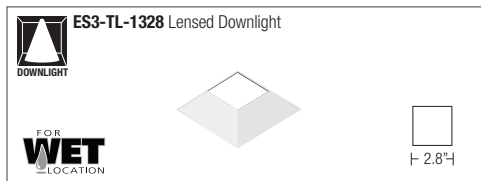
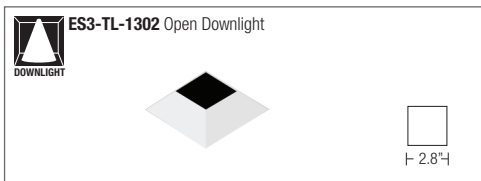

FLANGED OPTION:

Post-painted powder coated Die-Cast trim ring available in white and custom colors (Please consult factory for custom paint color options). Collar and trim rotate jointly, and a Solite frosted lens is standard on all trims (Please consult factory for additional lens options). Available in Open Downlight, Lensed Downlight, Pinhole Downlight, Slot, Adjustable Downlight Accent or Lensed Adjustable Wall Wash. Trims attach to the housing with piano springs for snug fit and zero light leakage.

FINISH



WH-White

CL-Chrome



SHZ-Satin Haze

BK-Black

TRIMLESS OPTION:

Die-Cast perforated mesh cover intended for installation in drywall or plaster ceilings. Mudding may be applied right up to the edge of the luminaire opening to provide a seamless appearance. Trimless accessory is secured to the housing to prevent fractures in the ceiling and/or drywall during and after installation. Trims attach to the housing with piano springs for snug fit and zero light leakage. Available in Open Downlight, Lensed Downlight, Pinhole Downlight, Slot, Adjustable Downlight Accent or Lensed Adjustable Wall Wash.

Note:

Additional lens filters must only be used on open non-lensed downlight trim options.

ORDERING GUIDE

	TYPE	LUMENS	DIMMING	VOLTAGE	OPTICS	CRI	EMERGENCY	OPTIONS
DIMS TO WARM	<input type="checkbox"/> ER3-SHAL-LED-WDM-30K-18K	<input type="checkbox"/> 900L <input type="checkbox"/> 1200L <input type="checkbox"/> 1500L	<input type="checkbox"/> DIMTR ¹ <input type="checkbox"/> DIM10 <input type="checkbox"/> LUTH ² <input type="checkbox"/> LUT2W ¹ <input type="checkbox"/> ELDO10.1 ² <input type="checkbox"/> ELDODALI.1 ² <input type="checkbox"/> ELDODMX.1 ²	<input type="checkbox"/> 120 <input type="checkbox"/> 277 <input type="checkbox"/> MVOLT (For 347V Consult Factory)	<input type="checkbox"/> SPD (15°) <input type="checkbox"/> ND (24°) <input type="checkbox"/> MD (35°) <input type="checkbox"/> NWD (45°) <input type="checkbox"/> WD (52°)	<input type="checkbox"/> 90+	<input type="checkbox"/> EMG-LED-10W <input type="checkbox"/> EMG-LED-20W <small>Only accessible from the top of the luminaire</small>	<input type="checkbox"/> Blank - Standard bar hangers (included) <input type="checkbox"/> BP31 - 27" C-channel bar hangers. <input type="checkbox"/> RIF - RIF filter <input type="checkbox"/> SF - Spray Foam suitable for insulation. (Consult factory for details) <input type="checkbox"/> CP - CCEA Chicago plenum

¹ DIMTR and LUT2W are available in 120V only ² LUTH, ELDO10.1, ELDODALI.1, and ELDODMX.1 are available in 120V and 277V

TRIM OPTIONS

TRIM & TRIM-LESS OPTIONS

ROUND TRIM OPTIONS				
FLANGE-LESS TRIM OPTIONS		FINISH		LENS FILTERS
<input type="checkbox"/> ER3-TL-1328* - Lensed Downlight (wet Location) <input type="checkbox"/> ER3-TL-1314** - Pinhole Downlight	<input type="checkbox"/> ER3-TL-1302* - Open Downlight	<input type="checkbox"/> W - White <input type="checkbox"/> CL - Chrome <input type="checkbox"/> SHZ -Satin Haze <input type="checkbox"/> BK -Black	<input type="checkbox"/> BP8MR16-FR - FROSTED <input type="checkbox"/> BP8MR16-SF - SOFT FOCUS <input type="checkbox"/> BP8MR16-CL - CLEAR <input type="checkbox"/> BP8MR16-UV - ULTRAVIOLET <input type="checkbox"/> 6BP8MR16-SP - SPREAD <input type="checkbox"/> BPmr16-HC - HONEY COMB <input type="checkbox"/> BPmr16-LI - LINEAR <input type="checkbox"/> BPmr16-SOL - SOLITE	<input type="checkbox"/> BP8MR16-BL - BLUE <input type="checkbox"/> BP8MR16-GR - GREEN <input type="checkbox"/> BP8MR16-PI - PINK <input type="checkbox"/> BP8MR16-PU - PURPLE <input type="checkbox"/> BP8MR16-DL - DAY LIGHT <input type="checkbox"/> BP8MR16-YE - YELLOW <input type="checkbox"/> BP8MR16-AM - AMBER <input type="checkbox"/> BP8MR16-OR - ORANGE <input type="checkbox"/> BP8MR16-RE - RED
FLANGED TRIM OPTIONS		<input type="checkbox"/> W-WH - White <input type="checkbox"/> CL-WH - Chrome <input type="checkbox"/> SHZ-WH -Satin Haze <input type="checkbox"/> BK-WH -Black	Note: Additional lens filters must only be used on open non-lensed downlight trim options	

SQUARE TRIM OPTIONS				
FLANGE-LESS TRIM OPTIONS		FINISH		LENS FILTERS
<input type="checkbox"/> ES3-TL-1328* - Lensed Downlight (wet Location) <input type="checkbox"/> ES3-TL-1314** - Pinhole Downlight	<input type="checkbox"/> ES3-TL-1302* - Open Downlight	<input type="checkbox"/> W - White <input type="checkbox"/> CL - Chrome <input type="checkbox"/> SHZ -Satin Haze <input type="checkbox"/> BK -Black	<input type="checkbox"/> BP8MR16-FR - FROSTED <input type="checkbox"/> BP8MR16-SF - SOFT FOCUS <input type="checkbox"/> BP8MR16-CL - CLEAR <input type="checkbox"/> BP8MR16-UV - ULTRAVIOLET <input type="checkbox"/> 6BP8MR16-SP - SPREAD <input type="checkbox"/> BPmr16-HC - HONEY COMB <input type="checkbox"/> BPmr16-LI - LINEAR <input type="checkbox"/> BPmr16-SOL - SOLITE	<input type="checkbox"/> BP8MR16-BL - BLUE <input type="checkbox"/> BP8MR16-GR - GREEN <input type="checkbox"/> BP8MR16-PI - PINK <input type="checkbox"/> BP8MR16-PU - PURPLE <input type="checkbox"/> BP8MR16-DL - DAY LIGHT <input type="checkbox"/> BP8MR16-YE - YELLOW <input type="checkbox"/> BP8MR16-AM - AMBER <input type="checkbox"/> BP8MR16-OR - ORANGE <input type="checkbox"/> BP8MR16-RE - RED
FLANGED TRIM OPTIONS		<input type="checkbox"/> W-WH - White <input type="checkbox"/> CL-WH - Chrome <input type="checkbox"/> SHZ-WH -Satin Haze <input type="checkbox"/> BK-WH -Black	Note: Additional lens filters must only be used on open non-lensed downlight trim options	

*Driver only accessible from the top of the luminaire when using Trim-less application

**Pinhole and Slot are only available in black (Reflector) and white (Trim)

Emergency only accessible from the top of the luminaire

COLOR FILTERS & DISTRIBUTION FILTERS



MR16 LENS FILTER

CAT. #	COLOR
BP8MR16-BL	BLUE
BP8MR16-GR	GREEN
BP8MR16-PI	PINK
BP8MR16-PU	PURPLE
BP8MR16-DL	DAY LIGHT
BP8MR16-YE	YELLOW
BP8MR16-AM	AMBER
BP8MR16-OR	ORANGE
BP8MR16-RE	RED

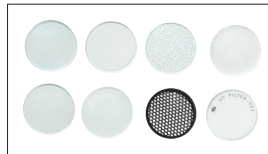

MR16 SPECIALTY LENS FILTER

CAT. #	COLOR
1. BP8MR16-FR	FROSTED
2. BP8MR16-SF	SOFT FOCUS
3. BP8MR16-CL	CLEAR
4. BP8MR16-UV	ULTRAVIOLET
5. 6BP8MR16-SP	SPREAD
6. BPmr16-HC	HONEY COMB
7. BPmr16-LI	LINEAR
8. BPmr16-SOL	SOLITE

Note:
Additional lens filters must only be used on open non-lensed downlight trim options.

*Please consult factory