



TRIM OPTIONS



ROUND FLANGED



SQUARE FLANGED

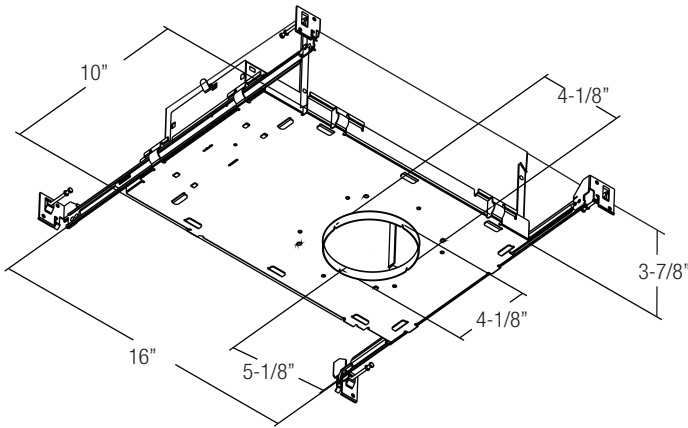

NOMINAL LUMENS	LEDENGINE
1500	20W
1200	-
900	10W

Based on 4000K, 90+ CRI. Actual wattage may vary +/- 5%

FEATURES

A small aperture, architectural LED downlight that delivers the ultimate in uncompromised quality and performance, with precise, glare-free illumination, and unmatched flexibility. With the use of a single universal housing, it utilizes a multitude of trims, field changeable optics, and is fully adjustable to any beam angle, up to 35 degrees, with a full 365-degree horizontal rotation. Whether it's high-end architectural, hospitality, commercial, residential, or retail, the ER3 provides the most innovative solution to any design application that requires a small aperture.

LUMENS	LED Engin Platform: 900, 1500
RGBW PLATFORMS	LED Engin: RGBW-LENGN-65K-18K (RGB + 65K to 18K)
CRI	90+ Standard
COLOR QUALITY	2 Step MacAdam Ellipse
DISTRIBUTION	SPD(Sport-15°), ND(Narrow-24°), MD(Medium-35°), MWD(Medium Wide-45°), WD(Wide-52°)
TRIM OPTIONS	Round and Square, Trim and Trimless, with Open Downlight, Lensed Downlight, Wall Wash, Adjustable Accent, and Pinhole Downlight,
REFLECTOR COLORS	WH (White), CL (Chrome), SHZ (Satin Haze), BK (Black)
FLANGE COLORS	WH (White)
DIMMING	ELDODMX.1
EMERGENCY	PELI-S-20, PELI-S-100, PELI-S-250, PELI-S-400
LIFETIME	L70 at 50,000 Hours
PHOTOMETRIC TESTS	In Accordance with IES LM79-08, LM80 and TM-30, TM-21
CCEA OPTION	For CCEA approved ER3 Family, please contact Elite Lighting for more information.

WD: WIDE
Candlepower Distribution Curve

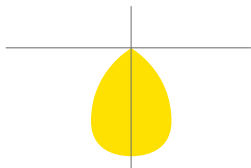

MWD: MEDIUM WIDE
Candlepower Distribution Curve

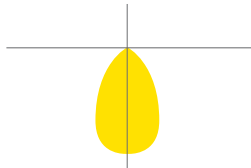

MD: MEDIUM
Candlepower Distribution Curve

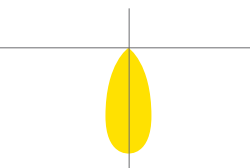

ND: NARROW
Candlepower Distribution Curve

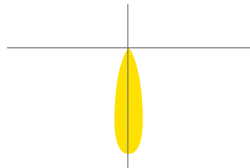

SPD: SPOT
Candlepower Distribution Curve

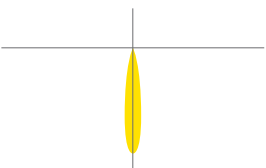

Reference IES files for additional distribution curve information.



FLANGED OPTION

Post-painted powder coated Die-Cast trim ring available in white and custom colors (Please consult factory for custom paint color options). Collar and trim rotate jointly, and a Solite frosted lens is standard on all trims (Please consult factory for additional lens options). Available in Open Downlight, Lensed Downlight, Pinhole Downlight, Slot, Adjustable Downlight Accent or Lensed Adjustable Wall Wash. Trims attach to the housing with piano springs for snug fit and zero light leakage.

TRIM-LESS OPTION

Die-Cast perforated mesh cover intended for installation in drywall or plaster ceilings. Mudding may be applied right up to the edge of the luminaire opening to provide a seamless appearance. Trimless accessory is secured to the housing to prevent fractures in the ceiling and/or drywall during and after installation. Trims attach to the housing with piano springs for snug fit and zero light leakage. Available in Open Downlight, Lensed Downlight, Pinhole Downlight, Slot, Adjustable Downlight Accent or Lensed Adjustable Wall Wash.

HOUSING

Designed for new construction installations and suitable for use in IC and Non IC applications. Thermally protected, specification grade adjustable recessed housing. For new construction insulated ceilings where housing will be in direct contact with insulation. die-formed all aluminum construction is painted matte black for maximum heat dissipation, rust protection and glare-free illumination.

MOUNTING

Pre-installed bar hangers allow housing to be positioned and locked at any point within a 24" joist span. They can be positioned on either the long or short axis of the housing and can be shortened for 12" joists. Bar hangers can fit onto T-Bar spline with additional slots and holes for special mounting methods, if necessary. Butterfly brackets are also provided and are constructed from 18-gauge steel and can be adjusted vertically. Butterfly brackets may be installed with 3/4" or 1-1/2" lathing channel, 1/2" EMT, or optional C-Channel mounting bars are available.

WARRANTY

Five-year warranty for parts and components. (Labor not included.)

LISTINGS

c-UL-us - Listed for Wet Location if used with 1328 or 1307 Trims
CP - City of Chicago Environmental Air (CCEA) marking for plenum applications (option)

DIMMING & DRIVER INFORMATION

Control via, DMX512-RDM, LUTECO, BLE, DALI.
LED Engin RGB+W platform produces a full spectrum of brilliant colors with tuning range of 6500K to 1800K (RGBW-LENGN-65K-18K).
Control via ELITE-CONNECT DMX WALL CONTROLLER (SR-2812) IP, DMX512, DMX-RDM, BLE, DALI

LED DYNAMIC PLATFORM OPTIONS



RGB + White technology has a white color tuning range from 8000K to 1650K. RGB color range derived from the primary colors red, green and blue is used to create infinite color options in the RGB palette, adding colors together in varying amounts to create new ones. RGB Tunable White technology enables users to adjust the color temperature, adding gradients of saturated colors. No longer restricted to white light LEDs, lighting designers and architects can manipulate a space with desired hues and shades, altering the color temperature of the room, creating the perfect environment. The use of RGB Tunable White technology in healthcare and assisted living stimulates circadian rhythm, accelerating the healing process.

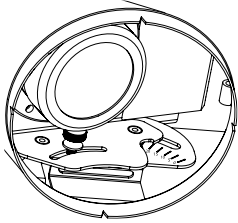

45°

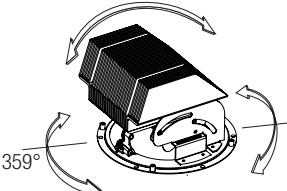

35°

OPTICS
SPD(Sport-15°),ND(Narrow-24°), MD(Medium-35°), MWD(Medium Wide-45°), WD(Wide-52°)

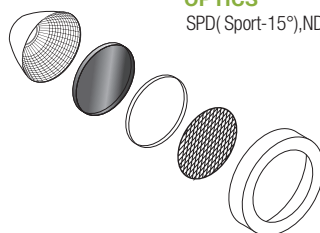

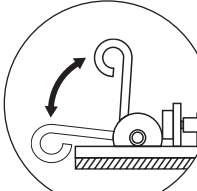

AIMING
Proprietary hot aiming system allows the lamp to be positioned at the perfect setting to ensure the proper position of the beam of light before trim is installed. Lamp holder is designed to ensure that the center beam of the light source emerges out of luminaire at any angled position from 0° to 35°.

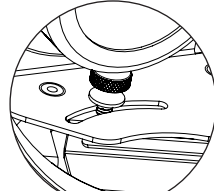

365° HORIZONTAL LOCKING
Effortlessly rotates on a 365° horizontal rotational smooth slotted groove track system

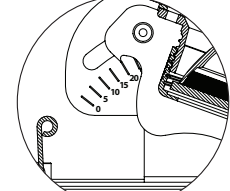

TOOL-LESS ADJUSTABILITY
Of the luminaire is to ensure whatever position is desired up to 35 degrees the beam and maximum lumen power is exiting the luminaire accordingly.

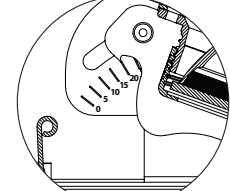

NUMERICAL DEGREE
Allows for the luminaires to be easily field adjusted for precision, performance, and versatility. At installation, you have the ability to lock the beam angle to 1 degree increments, which are marked at 5 degree increments.

Round Flanged Trim Options

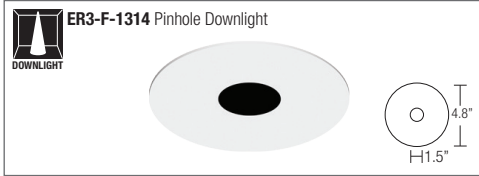
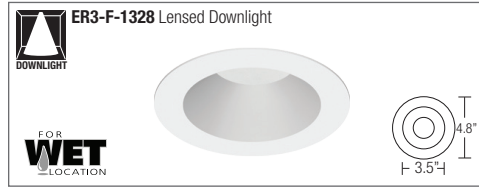
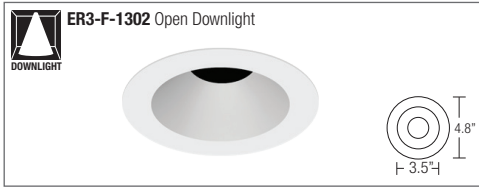

Trim-less

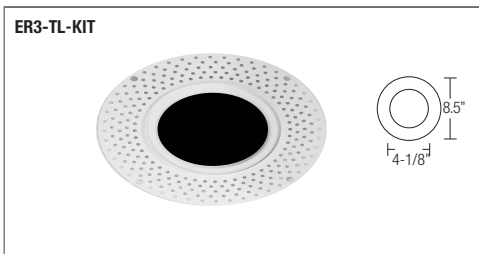

FLANGED OPTION:

Post-painted powder coated Die-Cast trim ring available in white and custom colors (Please consult factory for custom paint color options). Collar and trim rotate jointly, and a Solite frosted lens is standard on all trims (Please consult factory for additional lens options). Available in Open Downlight, Lensed Downlight, Pinhole Downlight, Slot, Adjustable Downlight Accent or Lensed Adjustable Wall Wash. Trims attach to the housing with piano springs for snug fit and zero light leakage.

FINISH



WH-White



CL-Chrome



SHZ-Satin Haze



BK-Black

TRIMLESS OPTION:

Die-Cast perforated mesh cover intended for installation in drywall or plaster ceilings. Mudding may be applied right up to the edge of the luminaire opening to provide a seamless appearance. Trimless accessory is secured to the housing to prevent fractures in the ceiling and/or drywall during and after installation. Trims attach to the housing with piano springs for snug fit and zero light leakage. Available in Open Downlight, Lensed Downlight, Pinhole Downlight, Slot, Adjustable Downlight Accent or Lensed Adjustable Wall Wash.

Note:

Additional lens filters must only be used on open non-lensed downlight trim options.

Square Flanged Trim Options

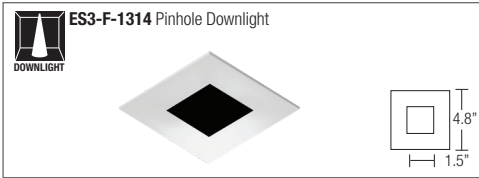
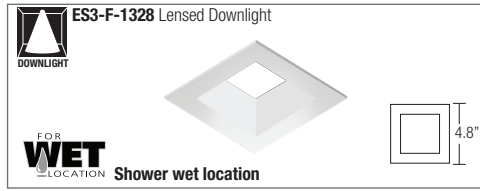
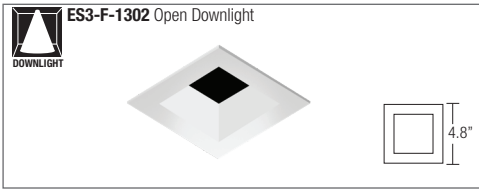

Square Trim-less Options

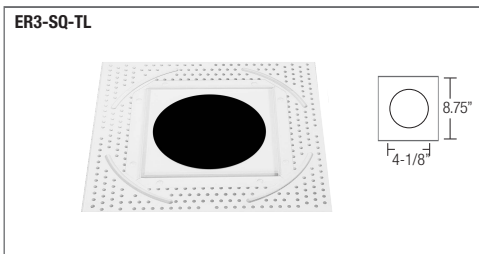

FLANGED OPTION:

Post-painted powder coated Die-Cast trim ring available in white and custom colors (Please consult factory for custom paint color options). Collar and trim rotate jointly, and a Solite frosted lens is standard on all trims (Please consult factory for additional lens options). Available in Open Downlight, Lensed Downlight, Pinhole Downlight, Slot, Adjustable Downlight Accent or Lensed Adjustable Wall Wash. Trims attach to the housing with piano springs for snug fit and zero light leakage.

FINISH



WH-White

CL-Chrome



SHZ-Satin Haze

BK-Black

TRIMLESS OPTION:

Die-Cast perforated mesh cover intended for installation in drywall or plaster ceilings. Mudding may be applied right up to the edge of the luminaire opening to provide a seamless appearance. Trimless accessory is secured to the housing to prevent fractures in the ceiling and/or drywall during and after installation. Trims attach to the housing with piano springs for snug fit and zero light leakage. Available in Open Downlight, Lensed Downlight, Pinhole Downlight, Slot, Adjustable Downlight Accent or Lensed Adjustable Wall Wash.

Note:

Additional lens filters must only be used on open non-lensed downlight trim options.

ORDERING GUIDE

TYPE	LUMEN	DIMMING	VOLTAGE	OPTICS	CRI	EMERGENCY	MOUNTING OPTIONS
<input type="checkbox"/> ER3-SHAL-ADJ-LED-RGBW-LENGN-65K-18K <small>SMART HUE</small>	<input type="checkbox"/> 900L <input type="checkbox"/> 1500L	<input type="checkbox"/> ELDODMX.1	<input type="checkbox"/> 120 <input type="checkbox"/> 277	<input type="checkbox"/> SPD (15°) <input type="checkbox"/> ND (24°) <input type="checkbox"/> MD (35°) <input type="checkbox"/> MWD (45°) <input type="checkbox"/> WD (52°)	<input type="checkbox"/> 90+	<input type="checkbox"/> PELI-S-20 <input type="checkbox"/> PELI-S-100 <input type="checkbox"/> PELI-S-250 <input type="checkbox"/> PELI-S-400	<input type="checkbox"/> Blank-Standard bar hangers (included) <input type="checkbox"/> BP31 - 27" C-channel bar hangers. <input type="checkbox"/> RIF - RIF filter. <input type="checkbox"/> SF - Spray Foam suitable for insulation. <small>(Consult factory for details)</small> <input type="checkbox"/> CP - CCEA Chicago Plenum

TRIM OPTIONS

TRIM & TRIM-LESS OPTIONS

ROUND TRIM OPTIONS			
TRIM OPTIONS	FINISH	LENS FILTERS	
<input type="checkbox"/> ER3-F-1328- Lensed Downlight (wet Location) <input type="checkbox"/> ER3-F-1307- Lensed Wall Wash (wet Location) <input type="checkbox"/> ER3-F-1314** - Pinhole Downlight <input type="checkbox"/> ER3-F-1303** - Slot	<input type="checkbox"/> ER3-F-1302- Open Downlight <input type="checkbox"/> ER3-F-1363- Open Adjustable Accent <input type="checkbox"/> ER3-TL-KIT* - Kit	<input type="checkbox"/> W-WH - White <input type="checkbox"/> CL-WH - Chrome <input type="checkbox"/> SHZ-WH-Satin Haze <input type="checkbox"/> BK-WH-Black	<input type="checkbox"/> BP8MR16-FR - FROSTED <input type="checkbox"/> BP8MR16-SF - SOFT FOCUS <input type="checkbox"/> BP8MR16-CL - CLEAR <input type="checkbox"/> BP8MR16-UV - ULTRAVIOLET <input type="checkbox"/> BP8MR16-SP - SPREAD <input type="checkbox"/> BPmr16-HC - HONEY COMB <input type="checkbox"/> BPmr16-LI - LINEAR <input type="checkbox"/> BPmr16-SOL - SOLITE Note: Additional lens filters must only be used on open non-lensed downlight trim options
		<input type="checkbox"/> BP8MR16-BL - BLUE <input type="checkbox"/> BP8MR16-GR - GREEN <input type="checkbox"/> BP8MR16-PI - PINK <input type="checkbox"/> BP8MR16-PU - PURPLE <input type="checkbox"/> BP8MR16-DL - DAY LIGHT <input type="checkbox"/> BP8MR16-YE - YELLOW <input type="checkbox"/> BP8MR16-AM - AMBER <input type="checkbox"/> BP8MR16-OR - ORANGE <input type="checkbox"/> BP8MR16-RE - RED	

SQUARE TRIM OPTIONS			
TRIM OPTIONS	FINISH	LENS FILTERS	
<input type="checkbox"/> ES3-F-1328- Lensed Downlight (wet Location) <input type="checkbox"/> ES3-F-1307- Lensed Wall Wash (wet Location) <input type="checkbox"/> ES3-F-1314** - Pinhole Downlight	<input type="checkbox"/> ES3-F-1302- Open Downlight <input type="checkbox"/> ES3-F-1363- Open Adjustable Accent <input type="checkbox"/> ES3-TL-KIT* - Kit	<input type="checkbox"/> W-WH - White <input type="checkbox"/> CL-WH - Chrome <input type="checkbox"/> SHZ-WH-Satin Haze <input type="checkbox"/> BK-WH-Black	<input type="checkbox"/> BP8MR16-FR - FROSTED <input type="checkbox"/> BP8MR16-SF - SOFT FOCUS <input type="checkbox"/> BP8MR16-CL - CLEAR <input type="checkbox"/> BP8MR16-UV - ULTRAVIOLET <input type="checkbox"/> BP8MR16-SP - SPREAD <input type="checkbox"/> BPmr16-HC - HONEY COMB <input type="checkbox"/> BPmr16-LI - LINEAR <input type="checkbox"/> BPmr16-SOL - SOLITE Note: Additional lens filters must only be used on open non-lensed downlight trim options
		<input type="checkbox"/> BP8MR16-BL - BLUE <input type="checkbox"/> BP8MR16-GR - GREEN <input type="checkbox"/> BP8MR16-PI - PINK <input type="checkbox"/> BP8MR16-PU - PURPLE <input type="checkbox"/> BP8MR16-DL - DAY LIGHT <input type="checkbox"/> BP8MR16-YE - YELLOW <input type="checkbox"/> BP8MR16-AM - AMBER <input type="checkbox"/> BP8MR16-OR - ORANGE <input type="checkbox"/> BP8MR16-RE - RED	

*Driver only accessible from the top of the luminaire when using Trim-less application

**Pinhole and Slot are only available in black (Reflector) and white (Trim)

Emergency only accessible from the top of the luminaire

COLOR FILTERS & DISTRIBUTION FILTERS



MR16 LENS FILTER

CAT. #	COLOR
BP8MR16-BL	BLUE
BP8MR16-GR	GREEN
BP8MR16-PI	PINK
BP8MR16-PU	PURPLE
BP8MR16-DL	DAY LIGHT
BP8MR16-YE	YELLOW
BP8MR16-AM	AMBER
BP8MR16-OR	ORANGE
BP8MR16-RE	RED

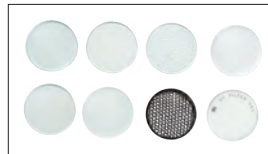

MR16 SPECIALTY LENS FILTER

CAT. #	COLOR
1. BP8MR16-FR	FROSTED
2. BP8MR16-SF	SOFT FOCUS
3. BP8MR16-CL	CLEAR
4. BP8MR16-UV	ULTRAVIOLET
5. BP8MR16-SP	SPREAD
6. BP8MR16-HC	HONEY COMB
7. BP8MR16-LI	LINEAR
8. BP8MR16-SOL	SOLITE

Note:

Additional lens filters must only be used on open non-lensed downlight trim options.

*Please consult factory