



TRIM OPTIONS



ROUND FLANGED



SQUARE FLANGED

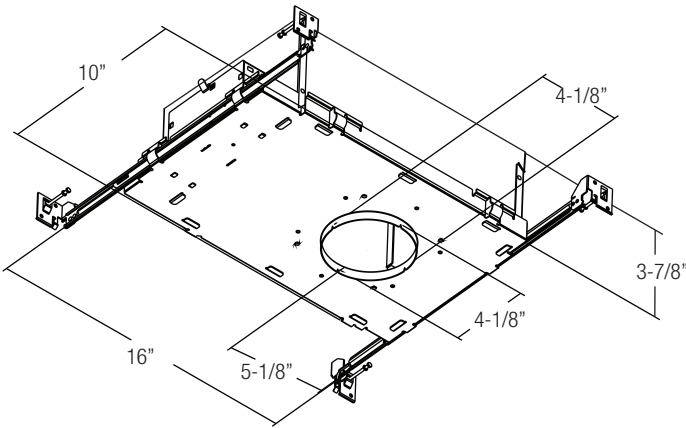

NOMINAL LUMENS	ELITE
1200	16W
900	12W

Based on 4000K, 90+ CRI. Actual wattage may vary +/- 5%

FEATURES

A small aperture, architectural LED downlight that delivers the ultimate in uncompromised quality and performance, with precise, glare-free illumination, and unmatched flexibility. With the use of a single universal housing, it utilizes a multitude of trims, field changeable optics, and is fully adjustable to any beam angle, up to 35 degrees, with a full 365-degree horizontal rotation. Whether it's high-end architectural, hospitality, commercial, residential, or retail, the ER3 provides the most innovative solution to any design application that requires a small aperture.

LUMENS	Elite Platform: 900, 1200
TUNABLE WHITE PLATFORMS	High Performance: TWH-50K-27K (50K to 27K) High Performance: TWH-65K-27K (65K to 27K)
CRI	90+ Standard
COLOR QUALITY	2 Step MacAdam Ellipse
DISTRIBUTION PATTERNS	SPD(Sport-15°), ND(Narrow-24°), MD(Medium-35°), MWD(Medium Wide-45°), WD(Wide-52°)
TRIM OPTIONS	Round and Square, Trim and Trimless, with Open Downlight, Lensed Downlight, Wall Wash, Adjustable Accent, and Pinhole Downlight,
REFLECTOR COLORS	WH (White), CL (Chrome), SHZ (Satin Haze), BK (Black)
FLANGE COLORS	WH (White)
DIMMING	1% Dimming Standard, 0-10V (DIM10), DMX-512 DMX-RDM, LUTH
EMERGENCY	10W - Up to 1000L Output (Bodine BSL310) 20W - Up to 2000L Output (Bodine BSL20)
LIFETIME	L70 at 50,000 Hours
PHOTOMETRIC TESTS	In Accordance with IES LM79-08, LM80 and TM-30, TM-21
CCEA OPTION	For CCEA approved ER3 Family, please contact Elite Lighting for more information.

WD: WIDE
Candlepower Distribution Curve

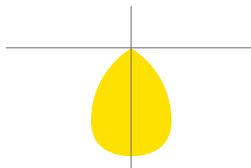

MWD: MEDIUM WIDE
Candlepower Distribution Curve

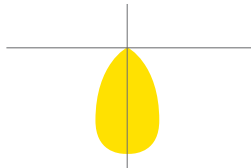

MD: MEDIUM
Candlepower Distribution Curve

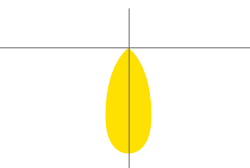

ND: NARROW
Candlepower Distribution Curve

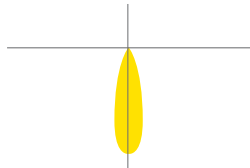

SPD: SPOT
Candlepower Distribution Curve

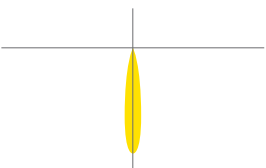

Reference IES files for additional distribution curve information.



FLANGED OPTION

Post-painted powder coated Die-Cast trim ring available in white and custom colors (Please consult factory for custom paint color options). Collar and trim rotate jointly, and a Solite frosted lens is standard on all trims (Please consult factory for additional lens options). Available in Open Downlight, Lensed Downlight, Pinhole Downlight, Slot, Adjustable Downlight Accent or Lensed Adjustable Wall Wash. Trims attach to the housing with piano springs for snug fit and zero light leakage.

TRIM-LESS OPTION

Die-Cast perforated mesh cover intended for installation in drywall or plaster ceilings. Mudding may be applied right up to the edge of the luminaire opening to provide a seamless appearance. Trimless accessory is secured to the housing to prevent fractures in the ceiling and/or drywall during and after installation. Trims attach to the housing with piano springs for snug fit and zero light leakage. Available in Open Downlight, Lensed Downlight, Pinhole Downlight, Slot, Adjustable Downlight Accent or Lensed Adjustable Wall Wash.

HOUSING

Designed for new construction installations and suitable for use in IC and Non IC applications. Thermally protected, specification grade adjustable recessed housing. For new construction insulated ceilings where housing will be in direct contact with insulation. die-formed all aluminum construction is painted matte black for maximum heat dissipation, rust protection and glare-free illumination.

MOUNTING

Pre-installed bar hangers allow housing to be positioned and locked at any point within a 24" joist span. They can be positioned on either the long or short axis of the housing and can be shortened for 12" joists. Bar hangers can fit onto T-Bar spline with additional slots and holes for special mounting methods, if necessary. Butterfly brackets are also provided and are constructed from 18-gauge steel and can be adjusted vertically. Butterfly brackets may be installed with 3/4" or 1-1/2" lathing channel, 1/2" EMT, or optional C-Channel mounting bars are available.

WARRANTY

Five-year warranty for parts and components. (Labor not included.)

LISTINGS

c-UL-us - Listed for Wet Location if used with 1328 or 1307 Trims.
CP - City of Chicago Environmental Air (CCEA) marking for plenum applications (option)

DIMMING & DRIVER INFORMATION

SMART WHITE High Performance platform with a tuning range of 5000K to 2700K (TWH-50K-27K).

Control via DIM10 (0-10V), ELITE-CONNECT 0-10V, LUTRON (Lutron PSQ02U T-series 1% 2-channel tunable white driver), DMX512-RDM, DALI

LED DYNAMIC PLATFORM OPTIONS





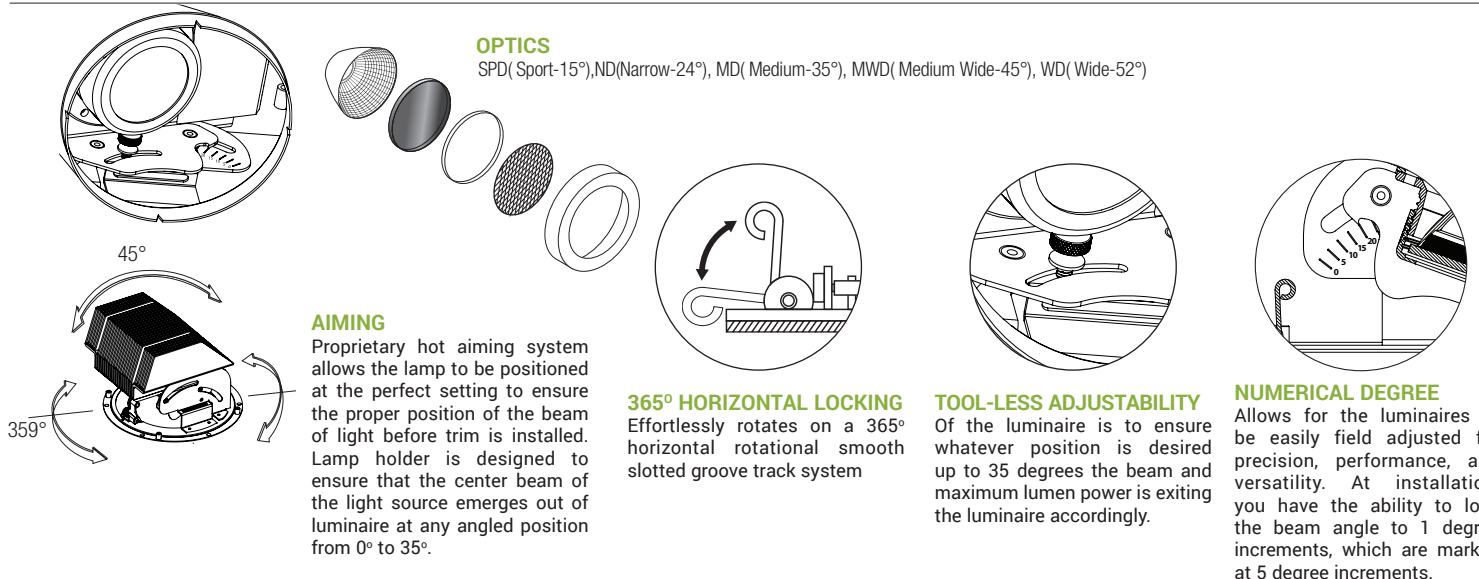

Tunable White with Smart White technology allows the tuning of luminaires to mimic the natural color patterns throughout the day, enhancing interior office spaces, hospitality, and architectural elements. Tuning of intensity and color in classrooms enables a diversification in student activities, while the use of tunable white technology in healthcare stimulates circadian rhythm, accelerating the healing process. Complementing colors and textures in retail merchandising also has an impact on sales, utilizing the technology to adjust colors throughout the season. A CRI of 90+ is standard, and available on all three platforms. Elite Platform (50K-27K).



CONTROL OPTIONS

With the integration of controls, Elite Lighting now offers its products with controls-ready performance that increases energy efficiency, smarter space planning, and the enhancement of safety and productivity in the workplace. By utilizing these controls, Elite Lighting fixtures enable your customer's facility to run smarter, with the use of an easily controlled system through any platform.

CONTROL PROTOCOLS	SMART WHITE
<p><input type="checkbox"/> ELITE-CONNECT (EC-WC-TWH-HW-MVOLT) - Hard-wired, 0-10V, 120/277V wall mounted controller for CCT Tuning and Intensity Dimming through Simple Touch screen pad, provided by Elite Lighting. Programmable for up to 3-scenes, with a dimming range down to 1%. Applicable for office spaces, hospitality, educational, health care, and retail merchandising.</p>	
<p><input type="checkbox"/> DIM10 (0-10V 1% Dimming Standard) In order to Control the Color Tuning and dimming option with 0-10V driver you must dedicate two control inputs, one for the Dimming Control and another for CCT Tuning. Can be dimmed and tuned with 2 wall box dimmers and compatible with most control systems and or daylight harvesting systems.</p> <p><input type="checkbox"/> DIM10-LUTRON Compatible with Lutron GRAFIK Eye QS or GRAFIK Eye 3000 by using two GRX-TVI Lutron 0-10V Dimming interfaces; one to tune and another to control dimming. Also compatible with Lutron VIVE system by using two FCJS-010 PowPak or FCJS-ECO EcoSystem PowPak modules per fixture; one to tune and one to control dimming.</p>	
<p><input type="checkbox"/> DMX (Available on Elite, LED Engin) - Compatible with Digital Multiplex Con-troller, Available with two options: DMX-512: Standard DMX Controller and DMX-RDM: DMX Controller with Remote Device Management.</p>	
<p><input type="checkbox"/> LUTEKO Compatible with Lutron EcoSystem. Compatible with Lutron GRAFIK Eye EcoSystem, Lutron Energi Saver node EcoSystem, or Lutron Quantum systems.</p>	
<p><input type="checkbox"/> DALI Compatible with Digital Addressable Lighting Interface, available with two options: DT6 and DT8.</p>	
<p><input type="checkbox"/> DLM The combination of the Blanco 3 with DLM from Legrand Wattstopper enables simple commissioning, synonymous with DLM and the enhanced features and flexibility.</p>	<p>N/A</p>

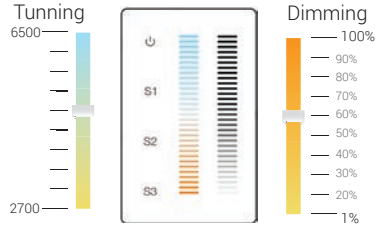

Round Flanged Trim Options

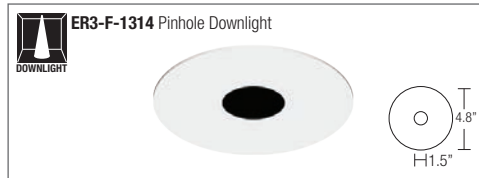
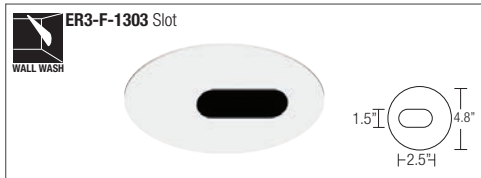
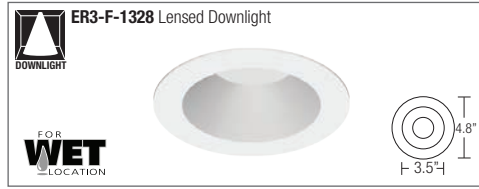
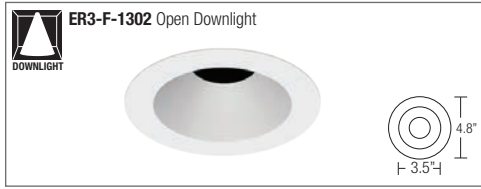

Round Trim-less Options

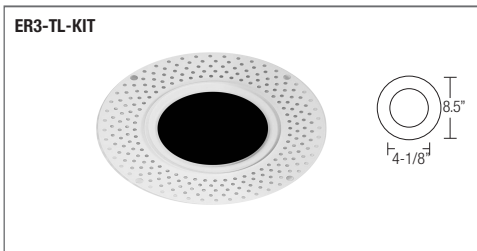

FLANGED OPTION:

Post-painted powder coated Die-Cast trim ring available in white and custom colors (Please consult factory for custom paint color options). Collar and trim rotate jointly, and a Solite frosted lens is standard on all trims (Please consult factory for additional lens options). Available in Open Downlight, Lensed Downlight, Pinhole Downlight, Slot, Adjustable Downlight Accent or Lensed Adjustable Wall Wash. Trims attach to the housing with piano springs for snug fit and zero light leakage.

FINISH



WH-White



CL-Chrome



SHZ-Satin Haze



BK-Black

TRIMLESS OPTION:

Die-Cast perforated mesh cover intended for installation in drywall or plaster ceilings. Mudding may be applied right up to the edge of the luminaire opening to provide a seamless appearance. Trimless accessory is secured to the housing to prevent fractures in the ceiling and/or drywall during and after installation. Trims attach to the housing with piano springs for snug fit and zero light leakage. Available in Open Downlight, Lensed Downlight, Pinhole Downlight, Slot, Adjustable Downlight Accent or Lensed Adjustable Wall Wash.

Note:

Additional lens filters must only be used on open non-lensed downlight trim options.

Square Flanged Trim Options

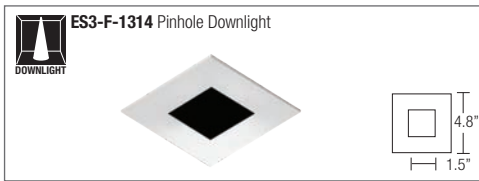
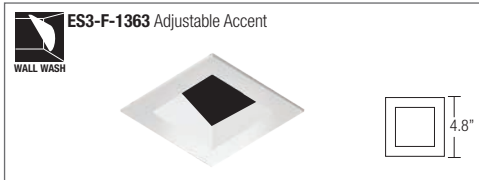
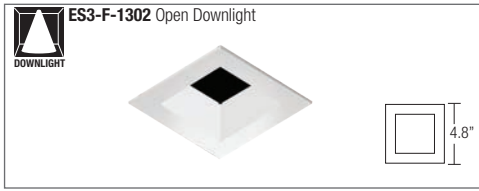

Square Trim-less Options

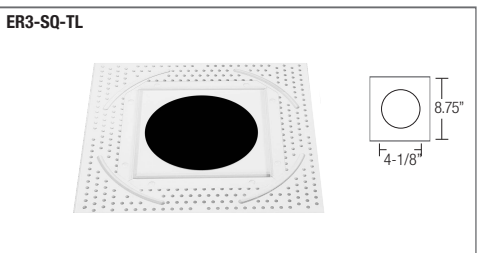

FLANGED OPTION:

Post-painted powder coated Die-Cast trim ring available in white and custom colors (Please consult factory for custom paint color options). Collar and trim rotate jointly, and a Solite frosted lens is standard on all trims (Please consult factory for additional lens options). Available in Open Downlight, Lensed Downlight, Pinhole Downlight, Slot, Adjustable Downlight Accent or Lensed Adjustable Wall Wash. Trims attach to the housing with piano springs for snug fit and zero light leakage.

FINISH



WH-White

CL-Chrome



SHZ-Satin Haze

BK-Black

TRIMLESS OPTION:

Die-Cast perforated mesh cover intended for installation in drywall or plaster ceilings. Mudding may be applied right up to the edge of the luminaire opening to provide a seamless appearance. Trimless accessory is secured to the housing to prevent fractures in the ceiling and/or drywall during and after installation. Trims attach to the housing with piano springs for snug fit and zero light leakage. Available in Open Downlight, Lensed Downlight, Pinhole Downlight, Slot, Adjustable Downlight Accent or Lensed Adjustable Wall Wash.

Note:

Additional lens filters must only be used on open non-lensed downlight trim options.

ORDERING GUIDE

	TYPE	LUMENS	DIMMING	VOLTAGE	OPTICS	CRI	EMERGENCY	DISC	WALL MOUNT CONTROLLER
TUNABLE WHITE ELITE	<input type="checkbox"/> ER3-SHAL-ADJ-LED-IC-TWH-50K-27K	<input type="checkbox"/> 900L	<input type="checkbox"/> DIM10*	<input type="checkbox"/> 120	<input type="checkbox"/> SPD (15°)	<input type="checkbox"/> 90+	<input type="checkbox"/> EMG-LED-10W	<input type="checkbox"/> Blank - Standard bar hangers (included)	<input type="checkbox"/> EC-WC-TWH-HW-MVOLT ¹
	<input type="checkbox"/> ER3-SHAL-ADJ-LED-IC-TWH-65K-27K	<input type="checkbox"/> 1200L	<input type="checkbox"/> LUTH <input type="checkbox"/> DMX-512 <input type="checkbox"/> DMX-RDM	<input type="checkbox"/> 277 <input type="checkbox"/> MVOLT <small>(For 347V Consult Factory)</small>	<input type="checkbox"/> ND (24°) <input type="checkbox"/> MD (35°) <input type="checkbox"/> MWD (45°) <input type="checkbox"/> WD (52°)		<input type="checkbox"/> EMG-LED-20W <small>Only accessible from the top of the luminaire</small>	<input type="checkbox"/> BP31 - 27" C-channel bar hangers. <input type="checkbox"/> RIF - RIF filter <input type="checkbox"/> SF - Spray Foam suitable for insulation. <small>(Consult factory for details)</small> <input type="checkbox"/> CP - CCEA Chicago Plenum	

For 0-10V driver you must dedicate two control inputs, one for the Dimming Control and another for CCT Tuning.

LUTRON - (Available on Elite platform) Compatible with Lutron GRAFIK Eye QS or GRAFIK Eye 3000 by using two GRX-TVI Lutron 0-10V Dimming interfaces, one to tune and another control dimming. Also compatible with Lutron VIVE system by using two FCJS-010 PowPak modules per luminaire, one to tune and one to control dimming.

¹ Compatible with Elite 0-10V Platform and LED Engin 0-10V Platform

TRIM OPTIONS

TRIM & TRIM-LESS OPTIONS

ROUND TRIM OPTIONS															
TRIM OPTIONS		FINISH													
<input type="checkbox"/> ER3-F-1328- Lensed Downlight (wet Location) <input type="checkbox"/> ER3-F-1307- Lensed Wall Wash (wet Location) <input type="checkbox"/> ER3-F-1314** - Pinhole Downlight <input type="checkbox"/> ER3-F-1303** - Slot	<input type="checkbox"/> ER3-F-1302- Open Downlight <input type="checkbox"/> ER3-F-1363- Open Adjustable Accent <input type="checkbox"/> ER3-TL-KIT* - Kit	<input type="checkbox"/> W-WH - White <input type="checkbox"/> CL-WH - Chrome <input type="checkbox"/> SHZ-WH-Satin Haze <input type="checkbox"/> BK-WH-Black	<input type="checkbox"/> BP8MR16-FR - FROSTED <input type="checkbox"/> BP8MR16-SF - SOFT FOCUS <input type="checkbox"/> BP8MR16-CL - CLEAR <input type="checkbox"/> BP8MR16-UV - ULTRAVIOLET <input type="checkbox"/> BP8MR16-SP - SPREAD <input type="checkbox"/> BPmr16-HC - HONEY COMB <input type="checkbox"/> BPmr16-LI - LINEAR <input type="checkbox"/> BPmr16-SOL - SOLITE Note: Additional lens filters must only be used on open non-lensed downlight trim options												
<table border="1" style="width: 100%;"> <thead> <tr> <th colspan="2">LENS FILTERS</th> </tr> </thead> <tbody> <tr> <td><input type="checkbox"/> BP8MR16-BL - BLUE</td> <td><input type="checkbox"/> BP8MR16-GR - GREEN</td> </tr> <tr> <td><input type="checkbox"/> BP8MR16-PI - PINK</td> <td><input type="checkbox"/> BP8MR16-PU - PURPLE</td> </tr> <tr> <td><input type="checkbox"/> BP8MR16-DL - DAY LIGHT</td> <td><input type="checkbox"/> BP8MR16-YE - YELLOW</td> </tr> <tr> <td><input type="checkbox"/> BP8MR16-AM - AMBER</td> <td><input type="checkbox"/> BP8MR16-OR - ORANGE</td> </tr> <tr> <td><input type="checkbox"/> BP8MR16-RE - RED</td> <td></td> </tr> </tbody> </table>				LENS FILTERS		<input type="checkbox"/> BP8MR16-BL - BLUE	<input type="checkbox"/> BP8MR16-GR - GREEN	<input type="checkbox"/> BP8MR16-PI - PINK	<input type="checkbox"/> BP8MR16-PU - PURPLE	<input type="checkbox"/> BP8MR16-DL - DAY LIGHT	<input type="checkbox"/> BP8MR16-YE - YELLOW	<input type="checkbox"/> BP8MR16-AM - AMBER	<input type="checkbox"/> BP8MR16-OR - ORANGE	<input type="checkbox"/> BP8MR16-RE - RED	
LENS FILTERS															
<input type="checkbox"/> BP8MR16-BL - BLUE	<input type="checkbox"/> BP8MR16-GR - GREEN														
<input type="checkbox"/> BP8MR16-PI - PINK	<input type="checkbox"/> BP8MR16-PU - PURPLE														
<input type="checkbox"/> BP8MR16-DL - DAY LIGHT	<input type="checkbox"/> BP8MR16-YE - YELLOW														
<input type="checkbox"/> BP8MR16-AM - AMBER	<input type="checkbox"/> BP8MR16-OR - ORANGE														
<input type="checkbox"/> BP8MR16-RE - RED															

SQUARE TRIM OPTIONS															
TRIM OPTIONS		FINISH													
<input type="checkbox"/> ES3-F-1328- Lensed Downlight (wet Location) <input type="checkbox"/> ES3-F-1307- Lensed Wall Wash (wet Location) <input type="checkbox"/> ES3-F-1314** - Pinhole Downlight	<input type="checkbox"/> ES3-F-1302- Open Downlight <input type="checkbox"/> ES3-F-1363- Open Adjustable Accent <input type="checkbox"/> ES3-TL-KIT* - Kit	<input type="checkbox"/> W-WH - White <input type="checkbox"/> CL-WH - Chrome <input type="checkbox"/> SHZ-WH-Satin Haze <input type="checkbox"/> BK-WH-Black	<input type="checkbox"/> BP8MR16-FR - FROSTED <input type="checkbox"/> BP8MR16-SF - SOFT FOCUS <input type="checkbox"/> BP8MR16-CL - CLEAR <input type="checkbox"/> BP8MR16-UV - ULTRAVIOLET <input type="checkbox"/> BP8MR16-SP - SPREAD <input type="checkbox"/> BPmr16-HC - HONEY COMB <input type="checkbox"/> BPmr16-LI - LINEAR <input type="checkbox"/> BPmr16-SOL - SOLITE Note: Additional lens filters must only be used on open non-lensed downlight trim options												
<table border="1" style="width: 100%;"> <thead> <tr> <th colspan="2">LENS FILTERS</th> </tr> </thead> <tbody> <tr> <td><input type="checkbox"/> BP8MR16-BL - BLUE</td> <td><input type="checkbox"/> BP8MR16-GR - GREEN</td> </tr> <tr> <td><input type="checkbox"/> BP8MR16-PI - PINK</td> <td><input type="checkbox"/> BP8MR16-PU - PURPLE</td> </tr> <tr> <td><input type="checkbox"/> BP8MR16-DL - DAY LIGHT</td> <td><input type="checkbox"/> BP8MR16-YE - YELLOW</td> </tr> <tr> <td><input type="checkbox"/> BP8MR16-AM - AMBER</td> <td><input type="checkbox"/> BP8MR16-OR - ORANGE</td> </tr> <tr> <td><input type="checkbox"/> BP8MR16-RE - RED</td> <td></td> </tr> </tbody> </table>				LENS FILTERS		<input type="checkbox"/> BP8MR16-BL - BLUE	<input type="checkbox"/> BP8MR16-GR - GREEN	<input type="checkbox"/> BP8MR16-PI - PINK	<input type="checkbox"/> BP8MR16-PU - PURPLE	<input type="checkbox"/> BP8MR16-DL - DAY LIGHT	<input type="checkbox"/> BP8MR16-YE - YELLOW	<input type="checkbox"/> BP8MR16-AM - AMBER	<input type="checkbox"/> BP8MR16-OR - ORANGE	<input type="checkbox"/> BP8MR16-RE - RED	
LENS FILTERS															
<input type="checkbox"/> BP8MR16-BL - BLUE	<input type="checkbox"/> BP8MR16-GR - GREEN														
<input type="checkbox"/> BP8MR16-PI - PINK	<input type="checkbox"/> BP8MR16-PU - PURPLE														
<input type="checkbox"/> BP8MR16-DL - DAY LIGHT	<input type="checkbox"/> BP8MR16-YE - YELLOW														
<input type="checkbox"/> BP8MR16-AM - AMBER	<input type="checkbox"/> BP8MR16-OR - ORANGE														
<input type="checkbox"/> BP8MR16-RE - RED															

*Driver only accessible from the top of the luminaire when using Trim-less application

**Pinhole and Slot are only available in black (Reflector) and white (Trim)

Emergency only accessible from the top of the luminaire

COLOR FILTERS & DISTRIBUTION FILTERS



MR16 LENS FILTER

CAT. #	COLOR
BP8MR16-BL	BLUE
BP8MR16-GR	GREEN
BP8MR16-PI	PINK
BP8MR16-PU	PURPLE
BP8MR16-DL	DAY LIGHT
BP8MR16-YE	YELLOW
BP8MR16-AM	AMBER
BP8MR16-OR	ORANGE
BP8MR16-RE	RED

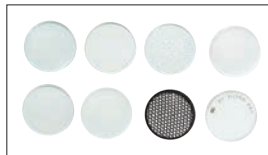

MR16 SPECIALTY LENS FILTER

CAT. #	COLOR
1. BP8MR16-FR	FROSTED
2. BP8MR16-SF	SOFT FOCUS
3. BP8MR16-CL	CLEAR
4. BP8MR16-UV	ULTRAVIOLET
5. BP8MR16-SP	SPREAD
6. BP8MR16-HC	HONEY COMB
7. BP8MR16-LI	LINEAR
8. BP8MR16-SOL	SOLITE

Note:

Additional lens filters must only be used on open non-lensed downlight trim options.

*Please consult factory

TWH-50K-27K

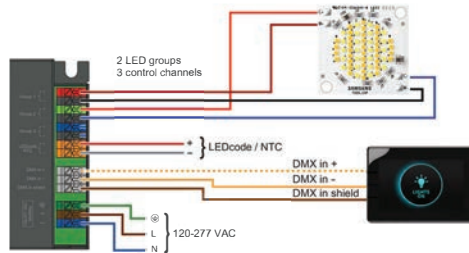
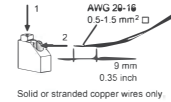
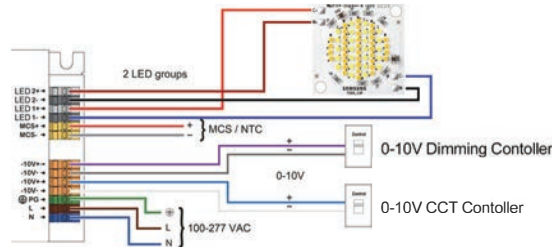

DMX512-A-RDM accessory board connects to an electrically isolated expansion port within the ALM

TWH Controller EC-WC-TWH-HW-MVOLT

Wiring Diagram:

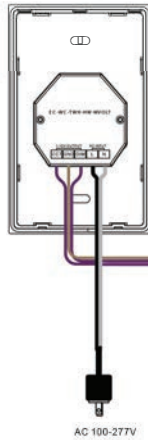

- 100-277VAC input.
- Touch slide tunable white and brightness control.
- 2 channels 1-10V signal output.
- 0.1%-100% dimming.
- Waterproof grade:IP20.
- Save up to max 3 different colors.

Safety & Warnings:

- DO NOT install with power applied to device.
- DO NOT expose the device to moisture.

Output Signal	2x(1-10V) signal
Power Supply	100-277VAC
Power consumption	30 mA max
Operating temperature	0-40°C
Relative humidity	8% to 80%
Dimensions	75x120x40.8mm

