



TRIM OPTIONS



ROUND FLANGED



ROUND TRIMLESS



SQUARE FLANGED

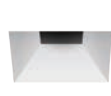

SQUARE TRIMLESS

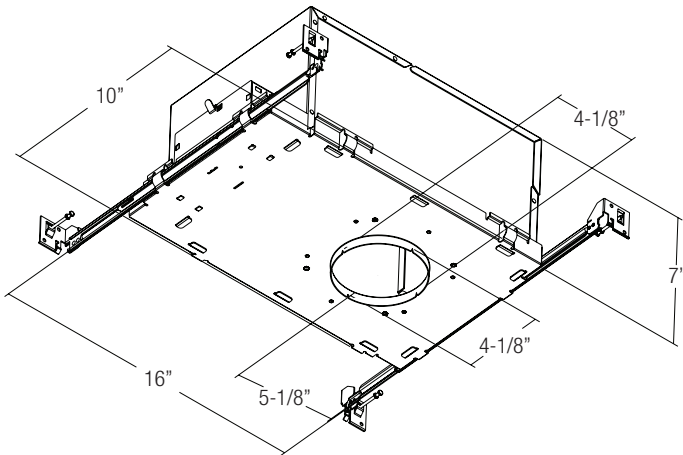

NOMINAL LUMENS	DELIVERED LUMENS	WATTAGE
2000	2509	26 W
1500	1527	18 W
1200	1392	16 W
900	1037	12 W
700	881	10 W

Based on 4000K, 90+ CRI. Actual wattage may vary +/- 5%

HIGH PERFORMANCE OPTIONS

NOMINAL LUMENS	DELIVERED LUMENS	WATTAGE
1500	1680	17 W
1200	1380	14 W

Based on 4000K, 90+ CRI. Actual wattage may vary +/- 5%

FEATURES

A small aperture, architectural LED downlight that delivers the ultimate in uncompromised quality and performance, with precise, glare-free illumination, and unmatched flexibility. With the use of a single universal housing, it utilizes a multitude of trims, field changeable optics, and is fully adjustable to any beam angle, up to 45 degrees, with a full 365-degree horizontal rotation. Whether it's high-end architectural, hospitality, commercial, residential, or retail, the ER3 provides the most innovative solution to any design application that requires a small aperture.

LUMENS	700, 900, 1200, 1500, 2000 (Custom lumen packages available)
CCT & DYNAMIC PLATFORMS	27K, 30K, 35K, 40K, 50K, Tunable White, Dims to Warm, RGB + White
CRI	90+ Standard, 98+ Optional
COLOR QUALITY	2 Step MacAdam Ellipse
DISTRIBUTIONS	SPD(Sport-15°), ND(Narrow-24°), MD(Medium-35°), MWD(Medium Wide-45°), WD(Wide-52°)
TRIM OPTIONS	Downlight, Lensed Downlight, Wall Wash, Adjustable Accent, and Pinhole, Square and Round Trim and Trim-less Options
REFLECTOR COLORS	WH (White), CL (Chrome), SHZ (Satin Haze), BK (Black)
FLANGE COLORS	WH (White)
DIMMING	0-10V Flicker Free 1% Dimming Standard (DIM10), LUTH, LUTFTB, LUT2W, ELD010.1, ELD0DMX.1, ELDODALI.1, DIMTR
EMERGENCY	10W - Up to 1000L Output (Bodine BSL310) 20W - Up to 2000L Output (Bodine BSL20)
LIFETIME	L70 at 102,000 Hours
PHOTOMETRIC TESTS	In Accordance with IES LM79-08, LM80 and TM-30, TM-21
CCEA OPTION	For CCEA approved ER3 Family, please contact Elite Lighting for more information.

WD: WIDE
Candlepower Distribution Curve

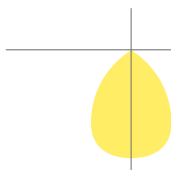

MWD: MEDIUM WIDE
Candlepower Distribution Curve



MD: MEDIUM
Candlepower Distribution Curve



ND: NARROW
Candlepower Distribution Curve

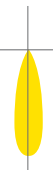

SPD: SPOT
Candlepower Distribution Curve



Reference IES files for additional distribution curve information.



FLANGED OPTION

Post-painted powder coated Die-Cast trim ring available in white and custom colors (Please consult factory for custom paint color options). Collar and trim rotate jointly, and a Solite frosted lens is standard on all trims (Please consult factory for additional lens options). Available in Open Downlight, Lensed Downlight, Pinhole Downlight, Slot, Adjustable Downlight Accent or Lensed Adjustable Wall Wash. Trims attach to the housing with piano springs for snug fit and zero light leakage.

TRIM-LESS OPTION

Die-Cast perforated mesh cover intended for installation in drywall or plaster ceilings. Mudding may be applied right up to the edge of the luminaire opening to provide a seamless appearance. Trimless accessory is secured to the housing to prevent fractures in the ceiling and/or drywall during and after installation. Trims attach to the housing with piano springs for snug fit and zero light leakage. Available in Open Downlight, Lensed Downlight, Pinhole Downlight, Slot, Adjustable Downlight Accent or Lensed Adjustable Wall Wash.

HOUSING

Designed for new construction installations and suitable for Non IC applications. Thermally protected, specification grade adjustable recessed housing. For new construction insulated ceilings where housing will be in direct contact with insulation. die-formed all aluminum construction is painted matte black for maximum heat dissipation, rust protection and glare-free illumination.

MOUNTING

Pre-installed bar hangers allow housing to be positioned and locked at any point within a 24" joist span. They can be positioned on either the long or short axis of the housing and can be shortened for 12" joists. Bar hangers can fit onto T-Bar spline with additional slots and holes for special mounting methods, if necessary. Butterfly brackets are also provided and are constructed from 18-gauge steel and can be adjusted vertically. Butterfly brackets may be installed with 3/4" or 1-1/2" lathing channel, 1/2" EMT, or optional C-Channel mounting bars are available.

WARRANTY

Five-year warranty for parts and components. (Labor not included)

LISTINGS

c-UL-us - Listed for Wet Location if used with 1328 or 1307 Trims.
c-UL-us - Listed for Feed Through Wiring.
CP - City of Chicago Environmental Air (CCEA) marking for plenum applications (option).
Energy Star, JA8 and California Title 24 compliant.

LED DYNAMIC PLATFORM OPTIONS

 Tunable White with Smart White Technology utilizing the Lumenetix Platform allows you to color tune the luminaire via various controls. Create the perfect environment for the desired use of the space, while maintaining a CRI of 90+ across the tunable range of 8000 to 1650K. (Click here for more details)

 Dims to Warm with Smart Dimming Technology. At 100% full brightness the luminaire is at 3000K. When dimmed to 1%, the light transitions to 1800K, creating a warm ambiance within the space. (Click here for more details)

 RGB+White with Smart Hue Technology provides full color mixing of RGB and white colors. Utilizing the Lumenetix Platform allows you to choose from unlimited RGB color options, via various controls. Ideal for Circadian Rhythm applications or to create the perfect human centric environment. (Click here for more details)

DIMMING & DRIVER INFORMATION

DIM10 - 0-10V dimming on either MVOLT 120V or 277V, 347V. Dimmable down to 1% of initial lumens, standard.

DIMTR - Triac & Electronic low voltage dimming. Available in 120V.

LUT2W - Lutron LTEA2W Hi-Lume 1%. 2-wire LED driver (120V forward phase only).

LUTH - Lutron LDE1 Hi-Lume 1% EcoSystem LED driver with Soft-on, Fade-to-Black dimming technology.

LUTFTB - Lutron PEQ0 Hi-Lume Premier Eco System. 0.1% dimming with Soft in Fade to Black dimming technology. Available on all luminaires up to 20 watts.

ELDO10.1 - EldoLED SoloDrive 0-10V. Dimming down to 0.1%.

DALI - DALI DT6, DT8 dimming down to 1%. Available on all luminaires up to 100 watts.

ELDDDMX - EldoLED PowerDrive dimming down to 0.1%. Please see EldoLED website for wiring diagrams and a list of compatible DMX and Dali control systems.

The LED driver is rated for 50 to 60Hz at 120V/277V input, produces less than 20%THD, and has a power factor between 90% and 100%, and is thermally protected for additional safety. Junction box and Driver can be accessed from below the ceiling and above the ceiling. Junction Box is Listed for through branch circuit wiring.

OPTICS

SPD (Sport-15°), ND (Narrow-24°), MD (Medium-35°), MWD (Medium Wide-45°), WD (Wide-52°)

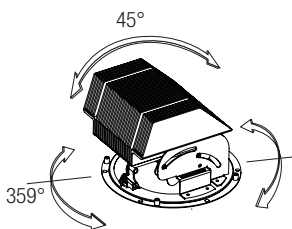
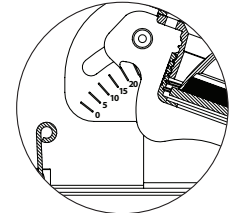
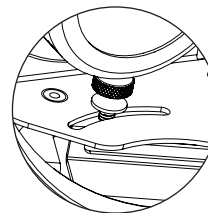
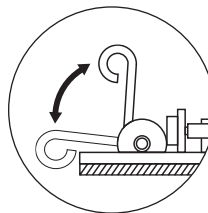
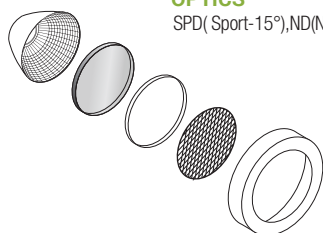
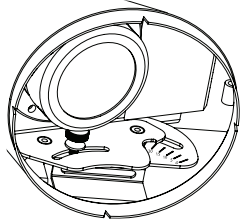

AIMING

Proprietary hot aiming system allows the lamp to be positioned at the perfect setting to ensure the proper position of the beam of light before trim is installed. Lamp holder is designed to ensure that the center beam of the light source emerges out of luminaire at any angled position from 0° to 45°.

365° HORIZONTAL LOCKING

Effortlessly rotates on a 365° horizontal rotational smooth slotted groove track system

TOOL-LESS ADJUSTABILITY

Of the luminaire is to ensure whatever position is desired up to 45 degrees the beam and maximum lumen power is exiting the luminaire accordingly

NUMERICAL DEGREE

Allows for the luminaires to be easily field adjusted for precision, performance, and versatility. At installation, you have the ability to lock the beam angle to 1 degree increments, which are marked at 5 degree increments.

Round Flanged Trim Options

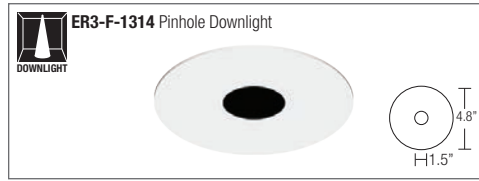
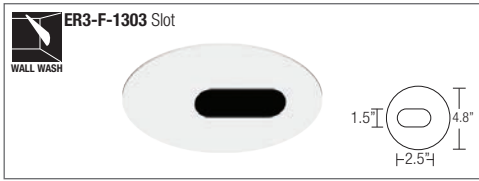
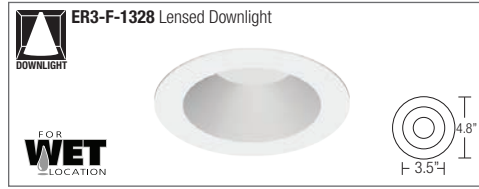
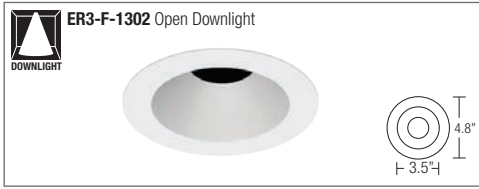

Round Trim-less Options

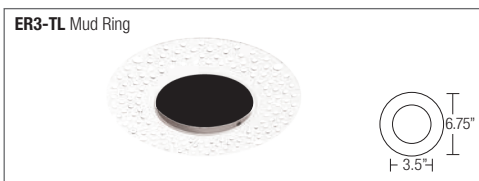
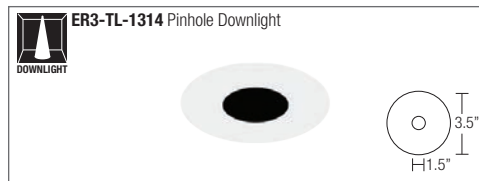
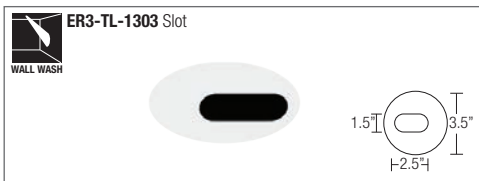
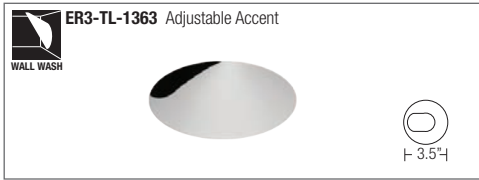
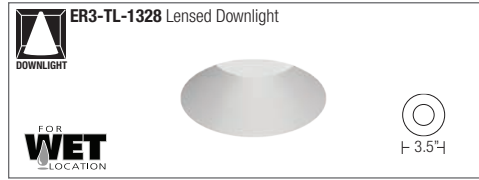
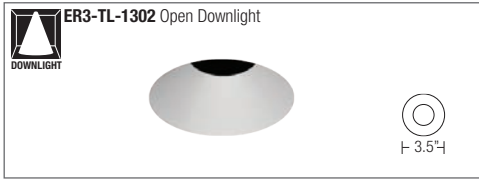

FLANGED OPTION:

Post-painted powder coated Die-Cast trim ring available in white and custom colors (Please consult factory for custom paint color options). Collar and trim rotate jointly, and a Solite frosted lens is standard on all trims (Please consult factory for additional lens options). Available in Open Downlight, Lensed Downlight, Pinhole Downlight, Slot, Adjustable Downlight Accent or Lensed Adjustable Wall Wash. Trims attach to the housing with piano springs for snug fit and zero light leakage.

FINISH

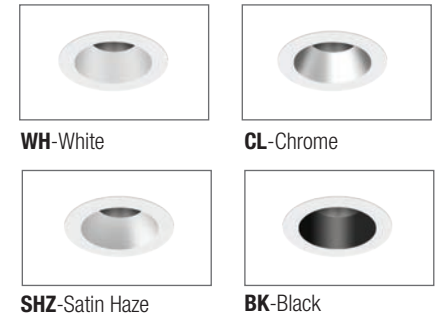

TRIMLESS OPTION:

Die-Cast perforated mesh cover intended for installation in drywall or plaster ceilings. Mudding may be applied right up to the edge of the luminaire opening to provide a seamless appearance. Trimless accessory is secured to the housing to prevent fractures in the ceiling and/or drywall during and after installation. Trims attach to the housing with piano springs for snug fit and zero light leakage. Available in Open Downlight, Lensed Downlight, Pinhole Downlight, Slot, Adjustable Downlight Accent or Lensed Adjustable Wall Wash.

Note:

Additional lens filters must only be used on open non-lensed downlight trim options

Square Flanged Trim Options

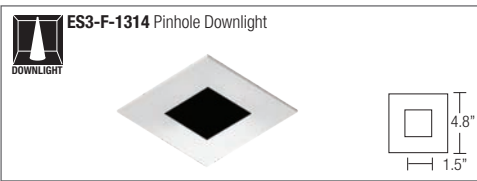
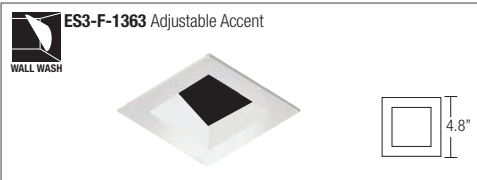
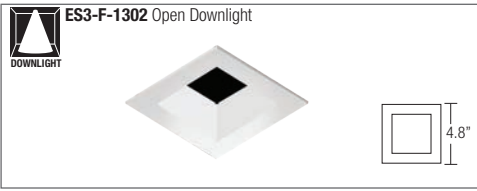

Square Trim-less Options

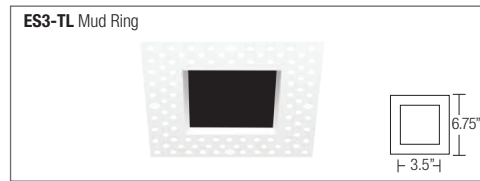
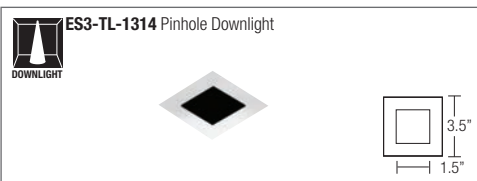
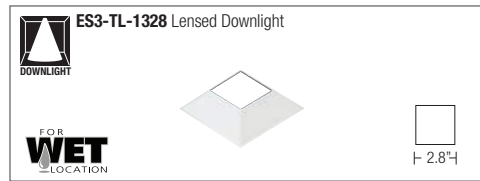
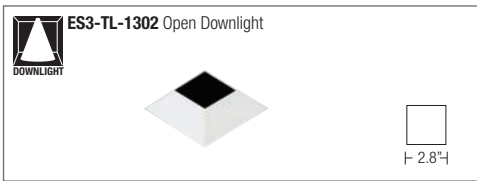

Square Trimless Option Only Offer With Ceiling Access

FLANGED OPTION:

Post-painted powder coated Die-Cast trim ring available in white and custom colors (Please consult factory for custom paint color options). Collar and trim rotate jointly, and a Solite frosted lens is standard on all trims (Please consult factory for additional lens options). Available in Open Downlight, Lensed Downlight, Pinhole Downlight, Slot, Adjustable Downlight Accent or Lensed Adjustable Wall Wash. Trims attach to the housing with piano springs for snug fit and zero light leakage.

FINISH



WH-White

CL-Chrome



SHZ-Satin Haze

BK-Black

TRIMLESS OPTION:

Die-Cast perforated mesh cover intended for installation in drywall or plaster ceilings. Mudding may be applied right up to the edge of the luminaire opening to provide a seamless appearance. Trimless accessory is secured to the housing to prevent fractures in the ceiling and/or drywall during and after installation. Trims attach to the housing with piano springs for snug fit and zero light leakage. Available in Open Downlight, Lensed Downlight, Pinhole Downlight, Slot, Adjustable Downlight Accent or Lensed Adjustable Wall Wash.

Note:

Additional lens filters must only be used on open non-lensed downlight trim options

ORDERING GUIDE

TYPE	LUMENS	DIMMING	VOLTAGE	OPTICS	CCT	CRI	EMERGENCY	OPTIONS
ER3-LED	<input type="checkbox"/> 700L	<input type="checkbox"/> DIM10	<input type="checkbox"/> 120	<input type="checkbox"/> SPD (15°)	<input type="checkbox"/> 27K	<input type="checkbox"/> 90+	<input type="checkbox"/> EMG-LED-10W	<input type="checkbox"/> Blank-Standard bar hangers (included)
	<input type="checkbox"/> 900L	<input type="checkbox"/> DIMTR	<input type="checkbox"/> 277	<input type="checkbox"/> ND (24°)	<input type="checkbox"/> 30K	<input type="checkbox"/> 98+	<input type="checkbox"/> EMG-LED-20W	<input type="checkbox"/> BP31 - 27" C-channel bar hangers.
	<input type="checkbox"/> 1200L	<input type="checkbox"/> LUTH	<input type="checkbox"/> 347	<input type="checkbox"/> MD (35°)	<input type="checkbox"/> 35K		<small>Only accessible from the top of the luminaire</small>	<input type="checkbox"/> RIF - RIF filter..
	<input type="checkbox"/> 1500L	<input type="checkbox"/> LUT2W	<input type="checkbox"/> (DIM10 only)	<input type="checkbox"/> MWD (45°)	<input type="checkbox"/> 40K			<input type="checkbox"/> CP - CCEA Chicago plenum
	<input type="checkbox"/> 2000L	<input type="checkbox"/> ELD010.1	<input type="checkbox"/> MVOLT	<input type="checkbox"/> WD (52°)	<input type="checkbox"/> 50K			<input type="checkbox"/> HP - High Performance (only 3500K and 4000K based on 90CRI.)
		<input type="checkbox"/> ELD0DALL1						
		<input type="checkbox"/> ELD0DMX.1						
		<input type="checkbox"/> LUTFTB						

- LUTFTB up to 1500L only. - LUT2W, DIMTR 120V only. - LUTH, ELD010.1, ELD0DALL1, ELD0DMX.1 120-277V only.

TRIM OPTIONS

TRIM & TRIM-LESS OPTIONS

ROUND TRIM OPTIONS				
FLANGE-LESS TRIM OPTIONS		FINISH		LENS FILTERS
<input type="checkbox"/> ER3-TL-1328* - Lensed Downlight (wet Location)	<input type="checkbox"/> ER3-TL-1302* - Open Downlight	<input type="checkbox"/> W - White	<input type="checkbox"/> BP8MR16-FR - FROSTED	<input type="checkbox"/> BP8MR16-BL - BLUE
<input type="checkbox"/> ER3-TL-1307* - Lensed Wall Wash (wet Location)	<input type="checkbox"/> ER3-TL-1363* - Open Adjustable Accent	<input type="checkbox"/> CL - Chrome	<input type="checkbox"/> BP8MR16-SF - SOFT FOCUS	<input type="checkbox"/> BP8MR16-GR - GREEN
<input type="checkbox"/> ER3-TL-1314** - Pinhole Downlight		<input type="checkbox"/> SHZ -Satin Haze	<input type="checkbox"/> BP8MR16-CL - CLEAR	<input type="checkbox"/> BP8MR16-PI - PINK
<input type="checkbox"/> ER3-TL-1303* - Slot		<input type="checkbox"/> BK -Black	<input type="checkbox"/> BP8MR16-UV - ULTRAVIOLET	<input type="checkbox"/> BP8MR16-PU - PURPLE
FLANGED TRIM OPTIONS			<input type="checkbox"/> 6BP8MR16-SP - SPREAD	<input type="checkbox"/> BP8MR16-DL - DAY LIGHT
<input type="checkbox"/> ER3-F-1328 - Lensed Downlight (wet Location)	<input type="checkbox"/> ER3-F-1302 - Open Downlight	<input type="checkbox"/> W-WH - White	<input type="checkbox"/> BPm16-HC - HONEY COMB	<input type="checkbox"/> BP8MR16-YE - YELLOW
<input type="checkbox"/> ER3-F-1307 - Lensed Wall Wash (wet Location)	<input type="checkbox"/> ER3-F-1363 - Open Adjustable Accent	<input type="checkbox"/> CL-WH - Chrome	<input type="checkbox"/> BPm16-LI - LINEAR	<input type="checkbox"/> BP8MR16-AM - AMBER
<input type="checkbox"/> ER3-F-1314** - Pinhole Downlight	<input type="checkbox"/> ER3-SF-1302 - Open Self-Flanged	<input type="checkbox"/> SHZ-WH -Satin Haze	<input type="checkbox"/> BPm16-SOL - SOLITE	<input type="checkbox"/> BP8MR16-OR - ORANGE
<input type="checkbox"/> ER3-F-1303** - Slot		<input type="checkbox"/> BK-WH -Black		<input type="checkbox"/> BP8MR16-RE - RED
		<input type="checkbox"/> MB-BK -Matt Black	Note: Additional lens filters must only be used on open non-lensed downlight trim options	

SQUARE TRIM OPTIONS				
FLANGE-LESS TRIM OPTIONS		FINISH		LENS FILTERS
<input type="checkbox"/> ES3-TL-1328* - Lensed Downlight (wet Location)	<input type="checkbox"/> ES3-TL-1302* - Open Downlight	<input type="checkbox"/> W - White	<input type="checkbox"/> BP8MR16-FR - FROSTED	<input type="checkbox"/> BP8MR16-BL - BLUE
<input type="checkbox"/> ES3-TL-1307* - Lensed Wall Wash (wet Location)	<input type="checkbox"/> ES3-TL-1363* - Open Adjustable Accent	<input type="checkbox"/> CL - Chrome	<input type="checkbox"/> BP8MR16-SF - SOFT FOCUS	<input type="checkbox"/> BP8MR16-GR - GREEN
		<input type="checkbox"/> SHZ -Satin Haze	<input type="checkbox"/> BP8MR16-CL - CLEAR	<input type="checkbox"/> BP8MR16-PI - PINK
		<input type="checkbox"/> BK -Black	<input type="checkbox"/> BP8MR16-UV - ULTRAVIOLET	<input type="checkbox"/> BP8MR16-PU - PURPLE
FLANGED TRIM OPTIONS			<input type="checkbox"/> 6BP8MR16-SP - SPREAD	<input type="checkbox"/> BP8MR16-DL - DAY LIGHT
<input type="checkbox"/> ES3-F-1328 - Lensed Downlight (wet Location)	<input type="checkbox"/> ES3-F-1302 - Open Downlight	<input type="checkbox"/> W-WH - White	<input type="checkbox"/> BPm16-HC - HONEY COMB	<input type="checkbox"/> BP8MR16-YE - YELLOW
<input type="checkbox"/> ES3-F-1307 - Lensed Wall Wash (wet Location)	<input type="checkbox"/> ES3-F-1363 - Open Adjustable Accent	<input type="checkbox"/> CL-WH - Chrome	<input type="checkbox"/> BPm16-LI - LINEAR	<input type="checkbox"/> BP8MR16-AM - AMBER
<input type="checkbox"/> ES3-F-1314** - Pinhole Downlight		<input type="checkbox"/> SHZ-WH -Satin Haze	<input type="checkbox"/> BPm16-SOL - SOLITE	<input type="checkbox"/> BP8MR16-OR - ORANGE
		<input type="checkbox"/> BK-WH -Black		<input type="checkbox"/> BP8MR16-RE - RED
		<input type="checkbox"/> MB-BK -Matt Black	Note: Additional lens filters must only be used on open non-lensed downlight trim options	

*Driver only accessible from the top of the luminaire when using Trim-less application. Square trimless option only offer with ceiling access.

**Pinhole and Slot are only available in black (Reflector) and white (Trim)

Emergency only accessible from the top of the luminaire

COLOR FILTERS & DISTRIBUTION FILTERS



MR16 LENS FILTER

CAT. #	COLOR
BP8MR16-BL	BLUE
BP8MR16-GR	GREEN
BP8MR16-PI	PINK
BP8MR16-PU	PURPLE
BP8MR16-DL	DAY LIGHT
BP8MR16-YE	YELLOW
BP8MR16-AM	AMBER
BP8MR16-OR	ORANGE
BP8MR16-RE	RED

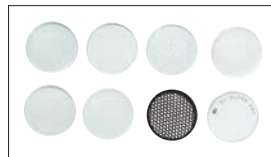

MR16 SPECIALTY LENS FILTER

CAT. #	COLOR
1. BP8MR16-FR	FROSTED
2. BP8MR16-SF	SOFT FOCUS
3. BP8MR16-CL	CLEAR
4. BP8MR16-UV	ULTRAVIOLET
5. 6BP8MR16-SP	SPREAD
6. BPm16-HC	HONEY COMB
7. BPm16-LI	LINEAR
8. BPm16-SOL	SOLITE

Note:
Additional lens filters must only be used on open non-lensed downlight trim options

*Please consult factory

1- Luminaire will be shipped with Powerpacks pre-installed, ready to be integrated to designated control systems

2- Luminaire will be shipped with Sensors installed on the luminaire, allowing for individual luminaire control. Luminaires will be ready to be integrated with designated control systems

3- Luminaire will be shipped with Sensors to be remotely installed on the ceiling. Luminaires will be ready to be integrated with designated control systems

BRAND	EASYFIT by EnOcean	LUTRON	enlighted	LEVITON	OSRAM	PHILIPS EasySense	legrand®
CONTROL UNIT	<input type="checkbox"/> LEDRU LED Relay Zone Controller 0-10V ¹	<input type="checkbox"/> FCJS-010 Lutron Vive 0-10V Individual Pow Pak (Luminaire is shipped Vive Enabled) ¹⁴	<input type="checkbox"/> CU-4E-FMH Fixture Mount Control Unit ¹⁵	<input type="checkbox"/> ZL027 –NOW Intellect Power Control Module ¹⁶	<input type="checkbox"/> EN-WCM2-ZB-DR Wireless Control Module ¹⁷	<input type="checkbox"/> SBR -BS Xtanium SR Bridge ¹⁸	<input type="checkbox"/> LMFC-011 ON/OFF/0-10V dimming fixture controller ¹⁹
	<input type="checkbox"/> LEDDU LED Zone Controller 0-10V ¹	<input type="checkbox"/> FCJS-ECO Lutron Vive Eco-system Pow Pak (Luminaire is shipped Vive Enabled) ¹⁴		<input type="checkbox"/> ZL027 –NOW Intellect Power Control Module ¹⁶	<input type="checkbox"/> EN- ALC-ZB-BK-DR Wireless Area Lighting Control Module ¹⁷		
INTEGRAT SENSOR	N/A	N/A	N/A	N/A	N/A	N/A	N/A
*WIRELESS OCCUPANCY SENSOR	<input type="checkbox"/> EOSCU-W-EO Occupancy Sensor - Ceiling Mounted (Must be specified with LEDRU or LEDDU control unit) ³	N/A	N/A	N/A	N/A	N/A	<input type="checkbox"/> LMDC-100 Dual technology PIR Ceiling Mount Occupancy Sensor ³
*WIRELESS DAYLIGHT SENSOR	<input type="checkbox"/> ELLSU-W-EO Light Level Sensor - Ceiling Mounted (Must be specified with LEDRU or LEDDU control unit) ³	N/A	N/A	N/A	N/A	N/A	<input type="checkbox"/> LMLS-400 Single zone switching and dimming digital photosensor ³
*WIRELESS OCCUPANCY & DAYLIGHT SENSOR	N/A	N/A	<input type="checkbox"/> SU-5E-IoT IoT Node Micro Sensor ³ <input type="checkbox"/> SU-5E-CL Connected Lighting Micro Sensor ³ <input type="checkbox"/> SU-5E-IL Independent Lighting / Enlighted One Micro Sensor ³ <input type="checkbox"/> SU-5S-H-(IoT/CL/IL) Surface Mount Sensor ³ (Must be specified with CU 4E-FMH Control Unit)	<input type="checkbox"/> ZL00J -TOW Intellect Intelligent Fixture Control System ³ (Must be specified with ZL027 –NOW Control Unit)	<input type="checkbox"/> EN-CLM-PIR-DD-ZB SensiLUM™ Wireless Integrated Sensor <input type="checkbox"/> EN-SCPPH-1500-ZB Wireless Passive Infrared Occupancy and Photo Sensors ³ (Must be specified with EN-WCM2-ZB-DR or EN- ALC-ZB-BK-DR Control Unit)	<input type="checkbox"/> SNS200- CMP SNS200 for grouping ³	N/A
ACCESORIES	N/A	N/A	<input type="checkbox"/> TMC-SU-5E Tile Mount Carrier <input type="checkbox"/> CBL-5E-CU4-30N 30 inch Sensor Cable for CU-4 and IoT Ready™ drivers <input type="checkbox"/> CBL-5E-CU4-7F 7 foot Sensor Cable for CU-4 and IoT Ready™ drivers	N/A	N/A	N/A	N/A
NOTES	N/A	4- Luminaire will be compatible with Lutron LRF2-OCR2B-P-WH Ceiling mount 360° occupancy/vacancy sensor & LRF2-DCRB-WH Ceiling-mount daylight sensor. Sensors must be ordered through Lutron.	5- Luminaire will be compatible with ENLIGHTED SU-5E-IoT, SU-5E-CL, SU-5E-IL, SU-5S-H, Sensors.	6-Luminaire will be compatible with Leviton Intellect App & Keypad Room Controller	7-Luminaire will be compatible with EN-SCPPH-1500-ZB Wireless Passive Infrared Occupancy and Photo Sensors	8-Luminaire will be compatible with Philips field and wireless switch.	9-Luminaire will be compatible with DLM Room control system LMPB-100. DLM control system must be orderd through Legrand.