



FEATURES

This post top light features an elegant design inspired by Victorian architecture for a traditional look. An ultra bright, uniform distribution, and adjustable lumen and CCT promote safety and ambiance. Ideal for bringing optimal light to courtyards, promenades, pathways, building entrances, and perimeters.

IP65 rated for outdoor wet location use.

TECHNICAL DETAILS

Lumens	8000L/11000L/13500L
CCT	3000K/4000K/5000K
Power	60W/80W/100W
Voltage	120-347V
Dimming	Flicker-free 0-10V Dimming
IP Rating	IP65
BUG Rating	B:2, U:1, G:1
Finish	Black (BK), Bronze (BZ), Custom RAL
Temperature	-40 °C (-40°F) to 40 °C (105°F)
Mounting	Pole mounting
Photometric	In accordance with IES LM79-08 and TM+30, TM-21
Warranty	5-year warranty for parts (labor not included)

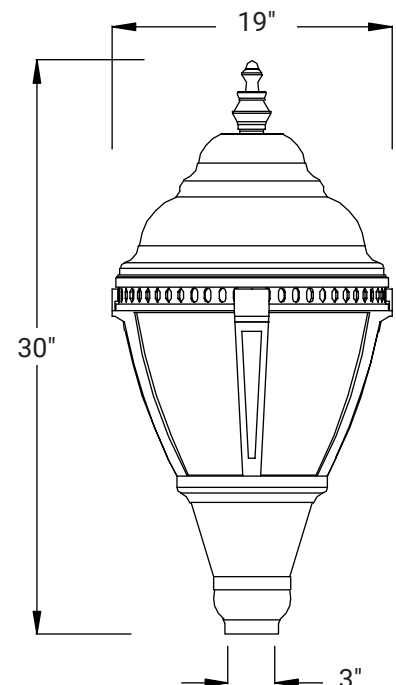

OPTICS & PERFORMANCE

Lens and cage panes made from clear polycarbonate for durability and for a bright, even, 360° illumination.

Luminaire available in 8000L/11000L/13500L, with 3 selectable color temperatures of 3000K/4000K/5000K to enable different warm to cool moods and atmospheres. CCT factory set to 3000K.

Available with T3 and T5 TIR optic at 110° and 149° beam angles, respectively.

CONSTRUCTION

Housing made from a light weight, durable, and heat resistant aluminum, with a spun aluminum top cover.

Lens, LED boards, and integrated driver attached to top cover.

Multi-lumen and multi-CCT switches located in luminaire top.

Available in standard finish of black; consult factory for custom RAL.

Sealed and IP65 rated for wet location and outdoor use. IK06 impact protection.

MOUNTING

Compatible with a standard 3" diameter pole; pole sold separately.

MAINTENANCE

Fixture may be wiped down with a dry or damp cloth or hosed down for optimal performance.

OPTIONS & ACCESSORIES

T3 (110°) and T5 (149°) TIR optics available to order separately.

Emergency Battery Back-Up option.

DRIVER ELECTRICAL INFORMATION

Powered by high-quality constant-current LED drivers which are rated for 50 to 60Hz at 120/277v input, produce less than 20% THD, and have a power factor of .90 to 1.00. Thermally protected for increased performance and safety.

DIMMING

DIM10 - Flicker-free 0-10V Dimming.

WARRANTY

5-year warranty for parts (labor not included).

LISTING

ETL listed.
IK06 rating for low risk impact protection.
IP65 rated for outdoor wet location use.

DISTRIBUTION

Type III



(Rectangular) Type III Distribution – forward throwing, medium width "batwing" shaped lighting great for roads, general parking areas, and intersections.

Type V

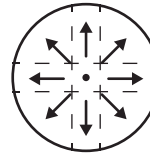

(Wide) Type V Distribution – produces a symmetrical circular or square pattern that illuminates equally on all sides of the luminaire. Ideal for large dark areas like lots or commercial parking areas.

Example: **ECH-OPL-2002-LED-8000L/11000L/13500L-DIM10-MVOLT-30K/40K/50K-T3-BK**

ECH-OPL-2002-LED							
SERIES	LUMENS	DIMMING	VOLTAGE	CCT	OPTICS	FINISH	OPTION
ECH-OPL-2002-LED	8000L/11000L/13500L	DIM10 (0-10V)	MVOLT (120-277V)	30K/40K/50K	T3 - 110° T5 - 149°	BK - Black BZ - Bronze RAL - Custom	0-EMG-LED - Emergency (consult factory for details)

ECH-OPL-2002-LED-8000L-11000L-13500L-DIM10-MVOLT-30K-40K-50K-T5-BK(8000L)

TEST NO.: EL10062502

INPUT WATTS:60.0

LUMENS:8768

EFFICACY: 146

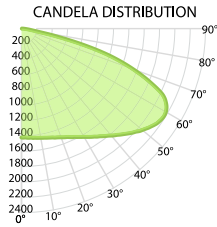

CANDELA TABLE		
	0°	90°
0°	1421	1421
10°	1446	1424
20°	1508	1464
30°	1630	1527
40°	1821	1568
50°	2057	1709
60°	2173	1745
70°	1550	978
80°	182	138
90°	5	1

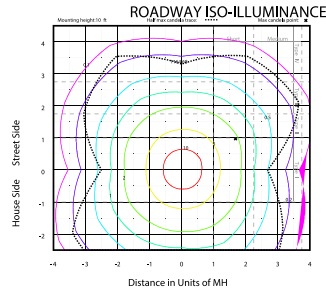

ZONAL LUMEN SUMMARY		
ZONE	LUMENS	% LUMINAIRE
0° - 20°	552	6%
0° - 30°	1266	14%
0° - 40°	2318	26%
0° - 60°	5552	63%
0° - 80°	8623	98%
0° - 90°	8750	100%

ECH-OPL-2002-LED-8000L-11000L-13500L-DIM10-MVOLT-30K-40K-50K-T5-BK(11000L)

TEST NO.: EL10062502

INPUT WATTS:78.9

LUMENS:11272

EFFICACY: 143

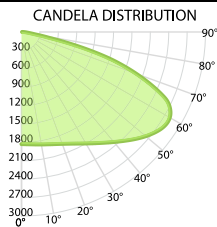

CANDELA TABLE		
	0°	90°
0°	1828	1828
10°	1861	1835
20°	1941	1886
30°	2099	1970
40°	2341	2023
50°	2644	2203
60°	2791	2247
70°	1988	1262
80°	232	178
90°	9	1

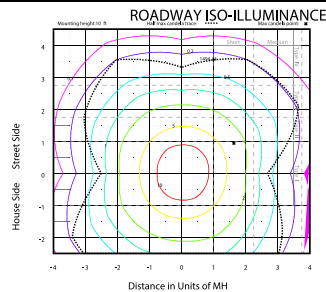

ZONAL LUMEN SUMMARY		
ZONE	LUMENS	% LUMINAIRE
0° - 20°	710	6%
0° - 30°	1630	14%
0° - 40°	2984	26%
0° - 60°	7144	63%
0° - 80°	11084	98%
0° - 90°	11247	100%

ECH-OPL-2002-LED-8000L-11000L-13500L-DIM10-MVOLT-30K-40K-50K-T5-BK(13500L)

TEST NO.: EL10062502

INPUT WATTS:94.5

LUMENS:13277

EFFICACY: 140

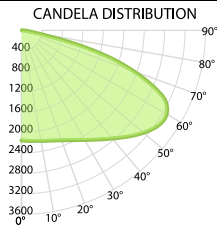

CANDELA TABLE		
	0°	90°
0°	2154	2154
10°	2196	2163
20°	2289	2221
30°	2476	2324
40°	2763	2385
50°	3117	2600
60°	3278	2645
70°	2331	1486
80°	269	214
90°	10	2

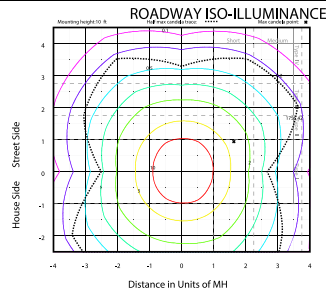

ZONAL LUMEN SUMMARY		
ZONE	LUMENS	% LUMINAIRE
0° - 20°	837	6%
0° - 30°	1922	14%
0° - 40°	3518	26%
0° - 60°	8422	63%
0° - 80°	13047	98%
0° - 90°	13239	100%