

NEW

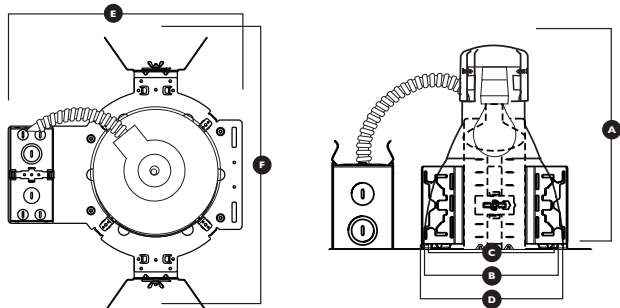

TRIM: 6101 REFLECTOR

MAX. LAMP WATTAGE: 150W-A21 / 150W PAR38 / 13W LED PAR30



- A. Min. Height = 8-1/2"
Max. Height = 9-1/4"
- B. Trim Aperture = 6-1/8"
- C. Cut-out = 6-3/4"
- D. Trim Outside Diameter = 7-3/8"
- E. Width = 12-7/8"
- F. Length = 15"



Lumen values rated at 3000K color temperature.

DESCRIPTION

This fixture can support the use of LED PAR replacement lamps.

1. SOCKET CUP - Die-cast aluminum with medium base pulse rated porcelain socket with nickel-plated screw shell, effectively provides heat dissipation and ventilation. Unitized optics guarantees proper trim to housing installation. Tool-less installation and adjustability from either outside the housing or inside the housing allows the fixture to accommodate three different lamp sizes.

2. MOUNTING BRACKET - Constructed from 16-gauge steel. Butterfly style mounting brackets accommodated. Constructed from 16-gauge steel. Can be installed with 3/4" or 1-1/2" lathing channel, 1/2" EMT, or with optional C-channel mounting bars (Part# BP31) ordered separately. Housing can be adjusted from the inside of the ceiling.

3. RETAINING SPRINGS - Precision tooled springs secure trim to mounting frame, for effortless and tool-less installation.

4. JUNCTION BOX - Is UL listed for through-branch circuit wiring and has four 1/2" KO's, one 3/4" KO and four Romex knockouts with pry-out slots and strain clamps. Junction Box are accessible from below, no tools required.

5. THERMAL PROTECTOR - Meets UL requirements. Standard thermal protection device guards against improper installation, over lamping and misuse of insulation material.

6. MOUNTING FRAME - Die-formed construction for maximum heat dissipation and rust protection.

OPTICS

7. REFLECTOR - Self-flanged .050" aluminum reflector with low iridescent finish. Reflector provides 45-degree lamp-to-reflector image cutoff.

8. GROOVE BAFFLE - Self-flanged one-piece aluminum with concentric rings.

9. LENS - Choice of either tempered clear, tempered prismatic or tempered frosted lens fastened with two torsion springs for easy re-lamping. UL listed for wet or damp location.

LISTING

/UL listed for through-branch circuit wiring and damp locations. Wet location only with lens trims.



Please visit our website for the most updated information on each product.

ITEM SELECTOR: (Please check the boxes below for the option desired)

TYPE	LAMP LUMEN	VOLTAGE	ANGLE	COLOR TEMPERATURE	TRIM TYPE & DESCRIPTION	REFLECTOR	BAFFLE	GLASS
C6INC	<input type="checkbox"/> PAR30-500L	<input type="checkbox"/> 120	<input type="checkbox"/> SP (10°)	<input type="checkbox"/> 27K	<input type="checkbox"/> 6101 Reflector	<input type="checkbox"/> 6109 Deco Glass Ring	<input type="checkbox"/> CL-WH	<input type="checkbox"/> Blue
	<input type="checkbox"/> PAR30-800L	<input type="checkbox"/> 277	<input type="checkbox"/> WS (15°)	<input type="checkbox"/> 30K	<input type="checkbox"/> 6102 Baffle with Reflector	<input type="checkbox"/> 6110 Double Ring Glass	<input type="checkbox"/> CL-SCH	<input type="checkbox"/> Green
	<input type="checkbox"/> PAR38-600L	(277 is not dimmable)	<input type="checkbox"/> NF (25°)	<input type="checkbox"/> 40K	<input type="checkbox"/> 6103 Reflector with Fresnel Glass Lens	<input type="checkbox"/> 6111 Triple Ring Glass	<input type="checkbox"/> SHZ-SHZ	<input type="checkbox"/> Red
	<input type="checkbox"/> PAR38-800L		<input type="checkbox"/> FL (40°)	<input type="checkbox"/> 6104 Reflector with Prismatic Glass Lens	<input type="checkbox"/> 6121 Stardust Deco Ring GLass	<input type="checkbox"/> SHZ-WH	<input type="checkbox"/> P-WH	<input type="checkbox"/> Frost
	<input type="checkbox"/> PAR38-1000L		<input type="checkbox"/> 6105 Baffle with Fresnel Glass Lens	<input type="checkbox"/> 6122 Euro Deco Ring GLass	<input type="checkbox"/> WT-WH			
	<input type="checkbox"/> PAR38-1300L		<input type="checkbox"/> 6106 Baffle with Prismatic Glass Lens	<input type="checkbox"/> 6123 Prism Deco Ring GLass	<input type="checkbox"/> W-WH			
	<input type="checkbox"/> NO LAMP		<input type="checkbox"/> 6107 Wall Wash	<input type="checkbox"/> 6124 Geo Deco Ring GLass	<input type="checkbox"/> MB-WH			
	OTHER OPTION	<input type="checkbox"/> 6108 Crossblade	<input type="checkbox"/> 6125 Central Etched Float GLass					
	<input type="checkbox"/> BP31	<input type="checkbox"/> 6112 Baffle with Frosted Glass Lens	<input type="checkbox"/> 6126 Diffusing Screen Wall Wash					
	(24" C-Channel Bar Hangers)	<input type="checkbox"/> 6113 Baffle with Tempered Clear Glass	<input type="checkbox"/> 6127 Geo Deco Ring GLass					
		<input type="checkbox"/> 6114 Reflector with Frosted Glass Lens						
		<input type="checkbox"/> 6115 Reflector with Tempered Clear Glass						

Specifications:

C6INC



Sample of Catalog Number: C6INC-120-6101-CL-WH

REFLECTOR	BAFFLE	GLASS
CL Clear	WH White	Only available on XX09, XX10 and XX11 series.
SHZ Satin Haze (Low Iridescent)	P Black	
WT Wheat	RING	
MB Black	WH Self-Flange White	
W White	SCH Self-Flange Chrome	
	SHZ Satin Haze	

*For custom baffle, reflector, trim ring, glass color and lens options, please consult factory.

6" LED LAMP / INCANDESCENT OPTICS

6101 -
Reflector



TRIM FINISH:

- CL-WH
- CL-SCH
- SHZ-SHZ
- SHZ-WH
- WT-WH
- W-WH
- MB-WH

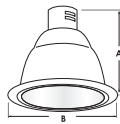

A= 7-1/8"
B= 7-3/8"

6102 -
Baffle with Reflector



TRIM FINISH:

- W-CL-WH
- P-CL-WH

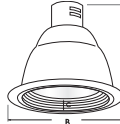

A= 7-1/8"
B= 7-3/8"
C= 1"

6107 -
Wall Wash Reflector



TRIM FINISH:

- CL-WH
- CL-SCH
- SHZ-SHZ
- SHZ-WH
- WT-WH
- W-WH
- MB-WH

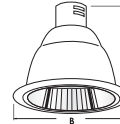

A= 7-1/8"
B= 7-3/8"

6108 -
Crossblade Reflector

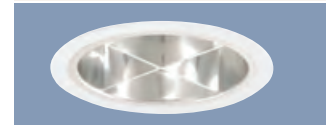

TRIM FINISH:

- CL-WH
- CL-SCH
- SHZ-SHZ
- SHZ-WH
- WT-WH
- W-WH
- MB-WH

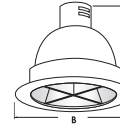

A= 7-1/2"
B= 7-3/8"

6103 -
Reflector with Fresnel Glass Lens



TRIM FINISH:

- CL-WH
- CL-SCH
- SHZ-SHZ
- SHZ-WH
- WT-WH
- W-WH
- MB-WH

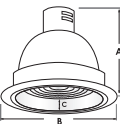

A= 7-1/2"
B= 7-3/8"
C= 1"



6104 -
Reflector with Prismatic Glass Lens

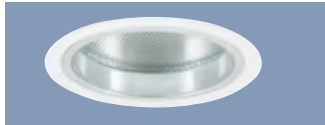

TRIM FINISH:

- CL-WH
- CL-SCH
- SHZ-SHZ
- SHZ-WH
- WT-WH
- W-WH
- MB-WH

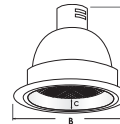

A= 7-1/2"
B= 7-3/8"
C= 1"



6114 -
Reflector with Frosted Glass Lens



TRIM FINISH:

- CL-WH
- CL-SCH
- SHZ-SHZ
- SHZ-WH
- WT-WH
- W-WH
- MB-WH

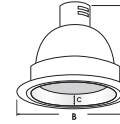

A= 7-1/2"
B= 7-3/8"
C= 1"



6115 -
Reflector with Tempered Clear Glass



TRIM FINISH:

- CL-WH
- CL-SCH
- SHZ-SHZ
- SHZ-WH
- WT-WH
- W-WH
- MB-WH

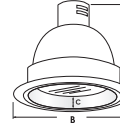

A= 7-1/2"
B= 7-3/8"
C= 1"



6105 -
Baffle with Fresnel Glass Lens

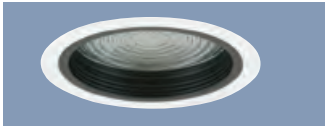

TRIM FINISH:

- W-WH
- P-WH

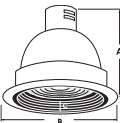

A= 7-1/2"
B= 7-3/8"
C= 1"



6106 -
Baffle with Prismatic Glass Lens

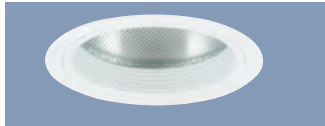

TRIM FINISH:

- W-WH
- P-WH

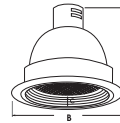

A= 7-1/2"
B= 7-3/8"
C= 1"



6112 -
Baffle with Frosted Glass Lens



TRIM FINISH:

- W-WH
- P-WH

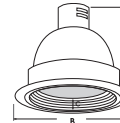

A= 7-1/2"
B= 7-3/8"
C= 1"



6113 -
Baffle with Tempered Clear Glass



TRIM FINISH:

- W-WH
- P-WH

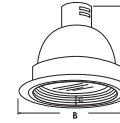

A= 7-1/2"
B= 7-3/8"
C= 1"



6109 -
Deco Glass Reflector

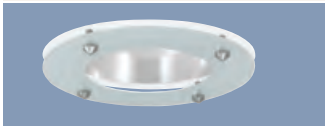

REFLECTOR FINISH:

- CL, WT, MB, SHZ, W

RING FINISH:

- WH, SCH, SHZ

GLASS FINISH:

- BLUE, RED, GREEN, FROST



A= 7-1/8"
B= 7-3/8"
C= 1-1/4"

6110 -
Double Ring Glass



REFLECTOR FINISH:

- CL, WT, MB, SHZ, W

RING FINISH:

- WH, SCH, SHZ

GLASS FINISH:

- BLUE, RED, GREEN, FROST

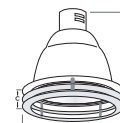

A= 7-1/8"
B= 7-3/8"
C= 1-1/2"

6111 -
Triple Ring Glass

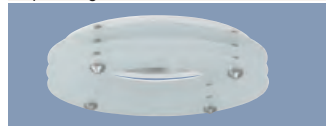

REFLECTOR FINISH:

- CL, WT, MB, SHZ, W

RING FINISH:

- WH, SCH, SHZ

GLASS FINISH:

- BLUE, RED, GREEN, FROST

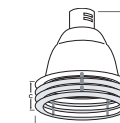

A= 7-1/8"
B= 7-3/8"
C= 2-1/4"

6125 -
Center Etched Float Glass



REFLECTOR FINISH:

- CL, WT, MB, SHZ, W

RING FINISH:

- WH, SCH, SHZ



A= 7-1/8"
B= 7-3/8"
C= 1-1/4"

*Also available in:
6126 -
Diffusing Screen Wall Wash

6121 -
Stardust Deco Ring Glass



REFLECTOR FINISH:

- CL, WT, MB, SHZ, W

RING FINISH:

- WH, SCH, SHZ



A= 7-1/8"
B= 7-3/8"
C= 1-1/4"

6122 -
Euro Deco Ring Glass



REFLECTOR FINISH:

- CL, WT, MB, SHZ, W

RING FINISH:

- WH, SCH, SHZ



A= 7-1/8"
B= 7-3/8"
C= 1-1/4"

6123 -
Prism Deco Ring Glass



REFLECTOR FINISH:

- CL, WT, MB, SHZ, W

RING FINISH:

- WH, SCH, SHZ



A= 7-1/8"
B= 7-3/8"
C= 1-1/4"

6124 -
Geo Deco Ring Glass



REFLECTOR FINISH:

- CL, WT, MB, SHZ, W

RING FINISH:

- WH, SCH, SHZ



A= 7-1/8"
B= 7-3/8"
C= 1-1/4"

*Also available in:
6127 -
Geo Deco Ring Glass