

# BL5

## 5" Low Voltage Non-IC Housing

LAMP WATTAGE: (1) MAXIMUM 12V 75W MR16



DESIGNED FOR 2" X 8" JOIST CONSTRUCTION

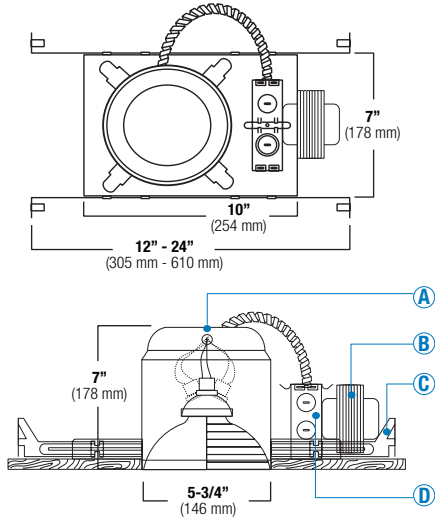

Catalog Number:

Project Name:

Type:

Note:



### DESCRIPTION

Low voltage, thermally protected, specification grade recessed housing. For new construction non-insulated ceilings or where insulation can be kept 3" from housing. Accommodates up to 50W MR16 lamps. Furnished with preinstalled adjustable bar hangers. Junction box is provided with four 1/2" KOs, one 3/4" KO and four Romex knockouts with strain relief.

### SPECIFICATION

**A. HOUSING** - High temperature painted 22 gauge cold rolled steel dissipation and rust protection. Adjusts vertically in plaster frame to accommodate 1/2" to 1-3/8" ceilings. Accommodate lamps up to 75W depending on trim used.

**B. TRANSFORMER** - Enhanced in heat dissipating cover, to provide noise free operation. Attached to junction box cover so it may be serviced from below the ceiling. Thermally protected.

- **M**-Class H dimming magnetic transformer.
- **E**-Class II dimming electronic transformer (LighTech part #LET 75 BF)
- **TOR**-Class H dimming toroidal transformer, providing 35% more lumens than traditional transformers. Constructed of M3 grade silicone steel. (Must use dimmers rated for electromagnetic transformer)

**C. BAR HANGERS** - Preinstalled bar hangers allow housing to be positioned and locked at any point within a 24" joist span. They can be positioned on either the long or short axis of the housing and can be shortened for 12" joists. They contain a double-headed real nail for 20° downward angle for better contact, and the 90° pivoting mounting plate makes installation fast and accurate. Bar hangers can fit onto T-Bar spline with additional slots and holes for special mounting methods if necessary.

**D. JUNCTION BOX** - listed for through-branch circuit wiring and has four 1/2" KOs, one 3/4" KO and four Romex knockouts with true pry-out slots and strain clamps.

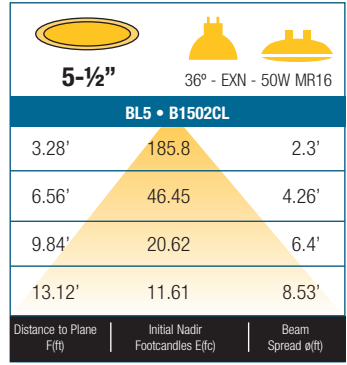

### FEATURES

- Integral low voltage magnetic transformer improves lamp life and lighting quality.
- Thermally Protected Non-IC housing.
- Designed for accent and task lighting applications.
- Wire through junction box.
- Dependable, favorable design and effortless installation.
- 7-1/4" height allows use in 2" x 8" joist construction.
- Special screw on the frame locks bar hangers in place which prevents the housing from any movement once installed.

### OPTIONS

#### 1. AIR-SHUT

- Gasket to prevent air flow from heated or air conditioned spaces.
- Meets all national air flow requirements.

BL5 - ITEM SELECTOR: (Please check the boxes below for the option desired)

WATTAGE	BALLAST	VOLTAGE	TRIM TYPE	BAFFLE	REFLECTOR	TRIM RING	MR 16 LENS FILTER
<input type="checkbox"/> 20W	<input type="checkbox"/> (M) Magnetic	<input type="checkbox"/> 120	<input type="checkbox"/> B1503	<input type="checkbox"/> W	<input type="checkbox"/> CL	<input type="checkbox"/> WH	<input type="checkbox"/> BP8MR16-BL (Blue)
<input type="checkbox"/> 35W	<input type="checkbox"/> (E) Electronic	<input type="checkbox"/> 277	<input type="checkbox"/> B1506	<input type="checkbox"/> P	<input type="checkbox"/> RG	<input type="checkbox"/> BK	<input type="checkbox"/> BP8MR16-GR (Green)
<input type="checkbox"/> 50W	<input type="checkbox"/> (TOR) Toroidal*		<input type="checkbox"/> B1508	<input type="checkbox"/> SN	<input type="checkbox"/> W	<input type="checkbox"/> SN	<input type="checkbox"/> BP8MR16-PI (Pink)
<input type="checkbox"/> 75W			<input type="checkbox"/> B1512	<input type="checkbox"/> CP	<input type="checkbox"/> MB	<input type="checkbox"/> CP	<input type="checkbox"/> BP8MR16-PU (Purple)
		<b>OPTION</b>	<input type="checkbox"/> B1520	<input type="checkbox"/> BZ	<input type="checkbox"/> BZ	<input type="checkbox"/> CH	<input type="checkbox"/> BP8MR16-DL (Day Light)
		<input type="checkbox"/> AT (Air-Shut)	<input type="checkbox"/> B1542		<input type="checkbox"/> CP	<input type="checkbox"/> PB	<input type="checkbox"/> BP8MR16-YE (Yellow)
			<input type="checkbox"/> B1524		<input type="checkbox"/> SN	<input type="checkbox"/> BZ	<input type="checkbox"/> BP8MR16-AM (Amber)
			<input type="checkbox"/> B1525		<input type="checkbox"/> SHZ		<input type="checkbox"/> BP8MR16-OR (Orange)
			<input type="checkbox"/> B1504				<input type="checkbox"/> BP8MR16-RE (Red)
			<input type="checkbox"/> B1514				
			<input type="checkbox"/> B1551				

\*TOR -Toroidal available only in BL5-50W-TOR-120V

### Specifications:

BL5

WATT	BALLAST	VOLTAGE	OPTION	TRIM TYPE	BAFFLE	REFLECTOR	TRIM/RING	FILTER (1)	FILTER (2)
------	---------	---------	--------	-----------	--------	-----------	-----------	------------	------------

BAFFLE	REFLECTOR	TRIM/RING
W White	CL Chrome	WH White
P Black	RG Gold	BK Black
SN Satin Nickel	W White	SN Satin Nickel
CP Copper	MB Black	CP Copper
BZ Bronze	BZ Bronze	CH Chrome
	CP Copper	PB Polish Brass
	SN Satin Nickel	BZ Bronze
	SHZ Satin Haze	

\*For custom baffle, reflector, trim ring, glass color and lens options, please consult factory.

Sample of Catalog Number: BL5-20W-E-B1503WH-BP8MR16-BL



Submittal form is available @ [www.iuseelite.com](http://www.iuseelite.com)  
Tel: 323-888-1973 • Fax: 323-888-1977

Specifications and Dimensions subject to change without notice.

REV: ELITE LIGHTING-SPEC-05-24-2011

# 5" Low Voltage Trims

(LAMP WATTAGE: 75W 12V MR16)







Catalog Number:

Project Name:

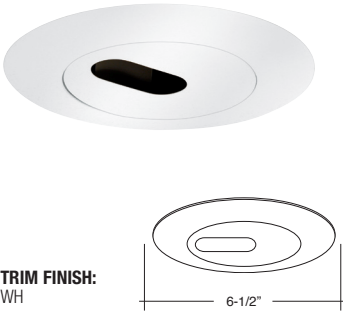
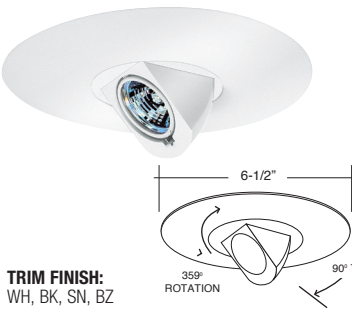
Type:

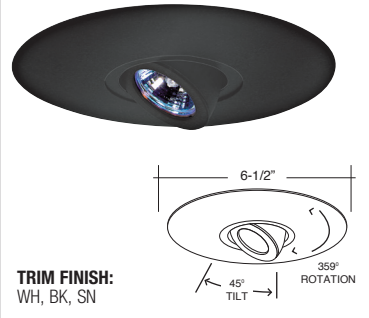
Note:

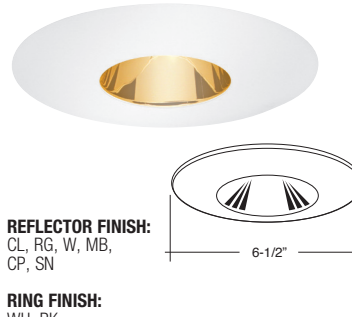
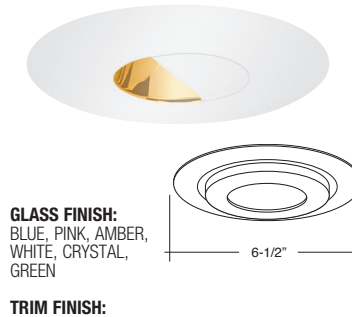

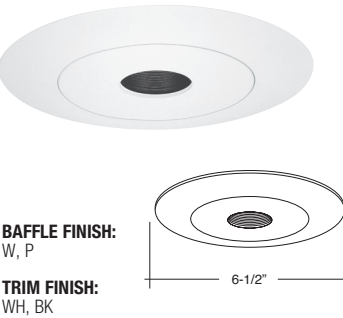
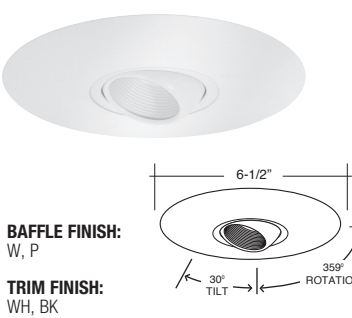
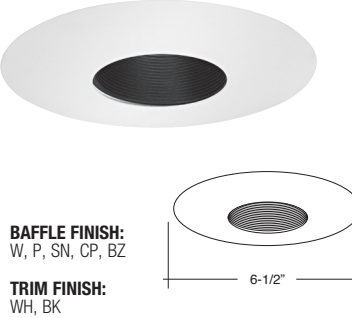
<p><b>B1503WH</b> SLOT APERTURE (30° TILT)</p>  <p>TRIM FINISH: WH</p>	<p><b>B1506WH</b> SURFACE FULLY ADJUSTABLE</p>  <p>TRIM FINISH: WH, BK, SN, BZ</p>	<p><b>B1508WH</b> ADJUSTABLE SPOT</p>  <p>TRIM FINISH: WH, BK, SN</p>	<p><b>B1512BK</b> SURFACE ADJUSTABLE</p>  <p>TRIM FINISH: WH, BK, SN</p>
<p><b>B1520W-WH</b> SEMI FROSTED SHOWER TRIM (30° TILT)</p>  <p>REFLECTOR FINISH: CL, RG, W, MB, CP, SN, BZ, SHZ</p> <p>RING FINISH: WH, BK</p> 	<p><b>B1542RG-WH</b> REFLECTOR</p>  <p>REFLECTOR FINISH: CL, RG, W, MB, CP, SN</p> <p>RING FINISH: WH, BK</p>	<p><b>B1524WH-PEACH</b> METROPOLITAN GLASS</p>  <p>GLASS FINISH: BLUE, PINK, AMBER, WHITE, CRYSTAL, GREEN</p> <p>TRIM FINISH: WH</p>	<p><b>B1525WH-BLUE</b> METROPOLITAN STEPPED GLASS</p>  <p>GLASS FINISH: BLUE, PINK, AMBER, WHITE, CRYSTAL, GREEN</p> <p>TRIM FINISH: WH</p>
<p><b>B1514P-WH</b> PINHOLE BAFFLE</p>  <p>BAFFLE FINISH: W, P</p> <p>TRIM FINISH: WH, BK</p>	<p><b>B1504W-WH</b> ADJUSTABLE EYEBALL</p>  <p>BAFFLE FINISH: W, P</p> <p>TRIM FINISH: WH, BK</p>	<p><b>B1551P-WH</b> STEPPED BAFFLE</p>  <p>BAFFLE FINISH: W, P, SN, CP, BZ</p> <p>TRIM FINISH: WH, BK</p>	

BAFFLE	REFLECTOR	TRIM RING
<b>W</b> White	<b>CL</b> Chrome	<b>WH</b> White
<b>P</b> Black	<b>RG</b> Gold	<b>BK</b> Black
<b>SN</b> Satin Nickel	<b>W</b> White	<b>SN</b> Satin Nickel
<b>CP</b> Copper	<b>MB</b> Black	<b>CP</b> Copper
<b>BZ</b> Bronze	<b>CP</b> Copper	<b>CH</b> Chrome
	<b>SN</b> Satin Nickel	<b>PB</b> Polish Brass
		<b>BZ</b> Bronze

\*For custom baffle, reflector, trim ring, glass color and lens options, please consult factory.