

B6PLRIC-E

6" Compact Fluorescent IC Remodel Housing

LAMP WATTAGE: UP TO 26W



DESIGNED FOR 2" X 8" JOIST CONSTRUCTION

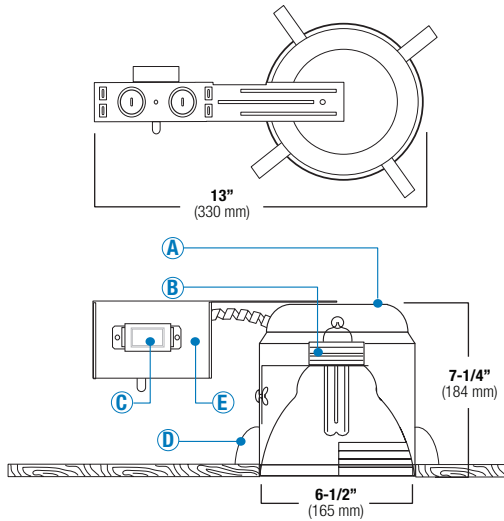

Catalog Number:

Project Name:

Type:

Note:



DESCRIPTION

Thermally protected, IC rated specification grade remodel compact fluorescent recessed housing. For remodeling installations where housing will be in direct contact with insulation. Accommodates (1) 4-pin compact fluorescent lamp. For fast and easy installation in existing plaster or mechanical ceilings from 1/2" to 1-3/8" thick. Four remodel clips are easily retractable for fixture removal if necessary. Junction box is provided with eight 1/2" KO's and four Romex knockouts with strain relief.

SPECIFICATION

A. HOUSING - Die-formed all aluminum construction for maximum heat dissipation and rust protection.

B. SOCKET - One vertically mounted plug-in socket. Unitized optics guarantees proper trim to housing installation. Tool-less installation adjusts from inside the housing.

C. BALLAST - Thermally protected, current controlled ballast, will produce full light output, increase lamp life with no noise and flicker. Ballast supplied is manufactured by Advance.

D. INSTALLATION - Four Preinstalled spring clips which secure the housing firmly into ceiling to accommodate ceiling thickness from 1/2" to 1-3/8".

E. JUNCTION BOX - feed through wiring and provided with eight 1/2" KO's and four Romex knock-outs with strain relief.

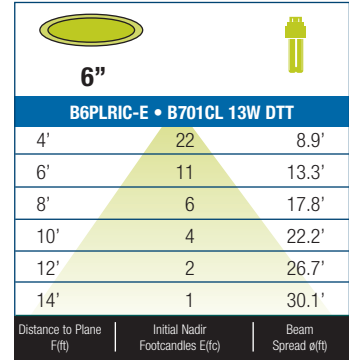

BEAM DIA. MEASURED AT 50% OF NADIR F.C.

FEATURES

- Thermally Protected remodel compact fluorescent IC housing.
- Integral fluorescent ballast.
- Unit slips through 6-1/2" ceiling opening.
- Four Preinstalled spring clips which secure the housing firmly into ceiling to accommodate ceiling thickness from 1/2" to 1-3/8".
- Can be installed from below the ceiling.
- Wire through junction box.
- Dependable, favorable design and effortless installation.
- 7-1/4" height allows use in 2" x 8" joist construction.

OPTIONS

AIR-SHUT

- Gasket to prevent air flow from heated or air conditioned spaces.
- Meets all national air flow requirements.



Title 24 Approved only if ordered with electronic ballast and Air-Shut.

B6PLRIC-E - ITEM SELECTOR: (Please check the boxes below for the option desired)

WATTAGE	BALLAST	VOLTAGE	EMERGENCY OPTIONS	TRIM TYPE	BAFFLE	REFLECTOR	TRIM/RING	GLASS
<input type="checkbox"/> 13W	<input type="checkbox"/> (E) Electronic	<input type="checkbox"/> 120	<input type="checkbox"/> EMG 750 (750 Lumens) ⁶	<input type="checkbox"/> B725 <input type="checkbox"/> B703 <input type="checkbox"/> B707 <input type="checkbox"/> B758	<input type="checkbox"/> W	<input type="checkbox"/> CL	<input type="checkbox"/> WH	<input type="checkbox"/> Green
<input type="checkbox"/> 18W	<input type="checkbox"/> (S) Energy Star ²	<input type="checkbox"/> 277	<input type="checkbox"/> EMG 1300 (1300 Lumens) ⁶	<input type="checkbox"/> B731 <input type="checkbox"/> B724 <input type="checkbox"/> B707L <input type="checkbox"/> B760	<input type="checkbox"/> P	<input type="checkbox"/> RG	<input type="checkbox"/> BK	<input type="checkbox"/> Yellow
<input type="checkbox"/> 26W			<input type="checkbox"/> EMG-D-750 (750 Lumens) ⁷	<input type="checkbox"/> B722 <input type="checkbox"/> B704 <input type="checkbox"/> B743 <input type="checkbox"/> B759	<input type="checkbox"/> SN	<input type="checkbox"/> W	<input type="checkbox"/> SN	<input type="checkbox"/> Pink
			<input type="checkbox"/> ICE-1300 (1300 Lumens) ⁸	<input type="checkbox"/> AF640 <input type="checkbox"/> B751 <input type="checkbox"/> B756 <input type="checkbox"/> B781	<input type="checkbox"/> CP	<input type="checkbox"/> MB	<input type="checkbox"/> CP	<input type="checkbox"/> Brown
				<input type="checkbox"/> B721 <input type="checkbox"/> B752 <input type="checkbox"/> B741 <input type="checkbox"/> B787	<input type="checkbox"/> BZ	<input type="checkbox"/> BZ	<input type="checkbox"/> CH	<input type="checkbox"/> Navy Blue
				<input type="checkbox"/> AF632 <input type="checkbox"/> B753 <input type="checkbox"/> B742 <input type="checkbox"/> B782		<input type="checkbox"/> CP	<input type="checkbox"/> PB	<input type="checkbox"/> Orange
				<input type="checkbox"/> B701 <input type="checkbox"/> B754 <input type="checkbox"/> B737 <input type="checkbox"/> B788		<input type="checkbox"/> SN	<input type="checkbox"/> BZ	<input type="checkbox"/> Blue
	DIMMING	AIR-SHUT	OTHER OPTIONS	<input type="checkbox"/> B702 <input type="checkbox"/> B705 <input type="checkbox"/> B755 <input type="checkbox"/> B785		<input type="checkbox"/> SHZ		<input type="checkbox"/> White
	<input type="checkbox"/> Mark 7 ³	<input type="checkbox"/> AT	<input type="checkbox"/> FUSE ⁹	<input type="checkbox"/> B729 <input type="checkbox"/> B705L <input type="checkbox"/> B735 <input type="checkbox"/> B796				<input type="checkbox"/> Red
	<input type="checkbox"/> Mark 10 ⁴		<input type="checkbox"/> RIF ¹⁰	<input type="checkbox"/> B620 <input type="checkbox"/> B706 <input type="checkbox"/> B736 <input type="checkbox"/> B780				
	<input type="checkbox"/> Lut-E (EC3D) ⁵			<input type="checkbox"/> B723 <input type="checkbox"/> B706L <input type="checkbox"/> B757 <input type="checkbox"/> B789				
	<input type="checkbox"/> REB-DIM-120							

(Note: CA Title 24 approved only if ordered with electronic ballast and Air-Shut.) 1- (M) Magnetic = Available only in 9W fixture and not available in MVOLT • 2- (S) Energy Star = Available on selected fixtures only, please see list above • 3- MARK 7 = Not available in 9W, 13W, 57W, 70W • 4- MARK 10 = Not available in 9W, 13W, 57W, 70W, must specify voltage • 5- LUT-E (EC3D) = Not available in 9W, 13W, 57W, 70W • 6- EMG = Emergency battery pack w/ remote test switch • 7- EMG-D = Emergency battery pack w/ remote test switch for damp location • 8- ICE = Emergency battery pack w/ remote test switch • 9- FUSE = Single slow-blow fuse • 10- RIF = Radio interference filter

Specifications:

B6PLRIC-E _____ WATT _____ BALLAST _____ VOLTAGE _____ AIR-SHUT _____ EMERGENCY _____ OPTIONS _____ TRIM TYPE _____ REFLECTOR _____ BAFFLE _____ RING _____ GLASS _____

BAFFLE	REFLECTOR	TRIM/RING
W White	CL Chrome	WH White
P Black	RG Gold	BK Black
SN Satin Nickel	W White	SN Satin Nickel
CP Copper	MB Black	CP Copper
BZ Bronze	BZ Bronze	CH Chrome
	CP Copper	PB Polish Brass
	SN Satin Nickel	BZ Bronze
	SHZ Satin Haze	

Sample of Catalog Number: **B6PLRIC-26W-E-MVOLT-EMG750-B731W-WH**

*For custom baffle, reflector, trim ring, glass color and lens options, please consult factory.



Submittal form is available @ www.iuseelite.com
Tel: 323-888-1973 • Fax: 323-888-1977

Specifications and Dimensions
subject to change without notice.

REV: ELITE LIGHTING-SPEC-06-29-2011

6" CFL Trims

(LAMP WATTAGE: UP TO 26W)

Catalog Number:

Project Name:

Type:

Note:



B725W-WH
BAFFLE WITH FROSTED DOME



AVAILABLE COLOR COMBINATIONS:
CP-CP, SN-SN, W-WH, P-WH, P-BK

B731W-WH
FULL CONE BAFFLE



AVAILABLE COLOR COMBINATIONS:
W-WH, P-WH, SN-SN, CP-CP, BZ-BZ

B722W-CL-WH
CONE REFLECTOR BAFFLE

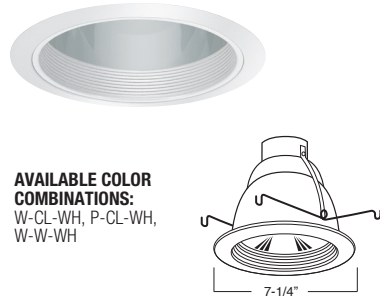

AVAILABLE COLOR COMBINATIONS:
W-CL-WH, P-CL-WH, W-W-WH

AF640W-WH
DEEP SELF FLANGE AIR-SHUT BAFFLE



AVAILABLE COLOR COMBINATIONS:
W-WH, P-WH, SN-SN, CP-CP, BZ-BZ

B721CL-WH
CONE REFLECTOR

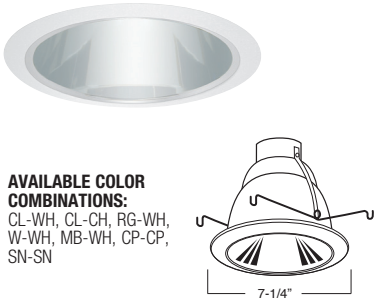

AVAILABLE COLOR COMBINATIONS:
CL-WH, CL-CH, RG-WH, W-WH, MB-WH, CP-CP, SN-SN

AF632RG-WH
AIR-SHUT REFLECTOR

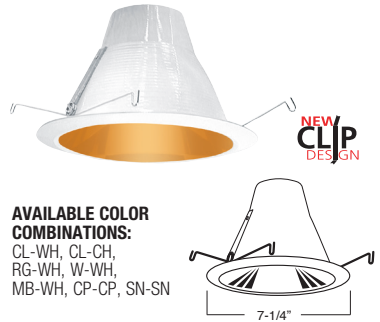

AVAILABLE COLOR COMBINATIONS:
CL-WH, CL-CH, RG-WH, W-WH, MB-WH, CP-CP, SN-SN

B701CP-WH
CONE REFLECTOR

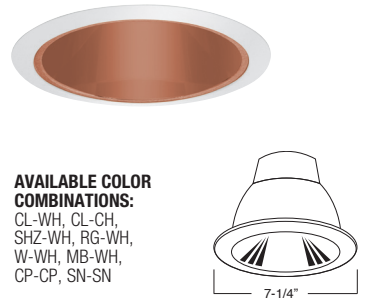

AVAILABLE COLOR COMBINATIONS:
CL-WH, CL-CH, SHZ-WH, RG-WH, W-WH, MB-WH, CP-CP, SN-SN

B702P-RG-WH
CONE REFLECTOR/BAFFLE TRIM

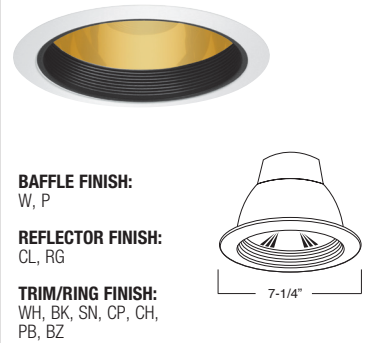

BAFFLE FINISH:
W, P
REFLECTOR FINISH:
CL, RG
TRIM/RING FINISH:
WH, BK, SN, CP, CH, PB, BZ

B729W-WH
BAFFLE WALL WASH



AVAILABLE COLOR COMBINATIONS:
W-WH, P-WH, SN-SN, CP-CP, BZ-BZ

COVER FINISH:
WH, BK

B620-NAVY BLUE
GLASS TRIM

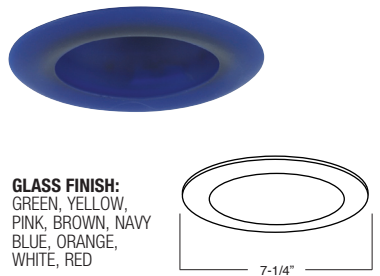

GLASS FINISH:
GREEN, YELLOW, PINK, BROWN, NAVY BLUE, ORANGE, WHITE, RED

B723MB-WH
WALL WASH REFLECTOR



AVAILABLE COLOR COMBINATIONS:
CL-WH, CL-CH, RG-WH, RG-PB, W-WH, MB-WH, CP-CP, SN-SN

COVER FINISH:
WH, BK

B703RG-WH
WALL WASH REFLECTOR

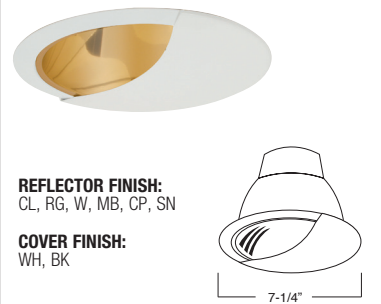

REFLECTOR FINISH:
CL, RG, W, MB, CP, SN

COVER FINISH:
WH, BK

B724W-CL-WH
REFLECTOR BAFFLE WALL WASH



AVAILABLE COLOR COMBINATIONS:
W-CL-WH, P-CL-WH, W-W-WH

COVER FINISH:
WH, BK

B704W-CL
REFLECTOR BAFFLE WALL WASH



BAFFLE FINISH:
W, P
REFLECTOR FINISH:
CL, RG
COVER FINISH:
WH, BK

B751WH
SMOOTH FROST DOME SHOWER LENS



LENS:
FROSTED

TRIM/RING FINISH:
WH, BK, SN, CP, CH, PB, BZ

B752WH
DESIGNER POINT SHOWER LENS

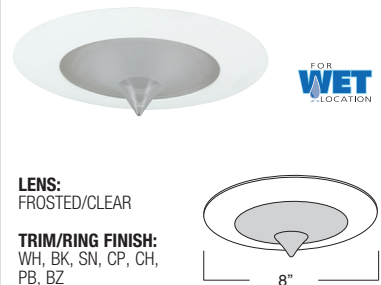

LENS:
FROSTED/CLEAR

TRIM/RING FINISH:
WH, BK, SN, CP, CH, PB, BZ

6" CFL Trims

(LAMP WATTAGE: UP TO 26W)

Catalog Number:

Project Name:

Type:

Note:



B753WH
DESIGNER CONE SHOWER LENS



LENS:
FROSTED

TRIM/RING FINISH:
WH, BK, SN, CP, CH,
PB, BZ

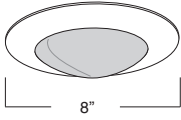

B754WH
SMOOTH FROST SHOWER LENS



LENS:
FROSTED

TRIM/RING FINISH:
WH, BK, SN, CP, CH,
PB, BZ

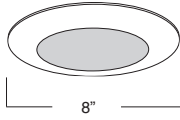

B705CP
METAL ALBALITE LENS

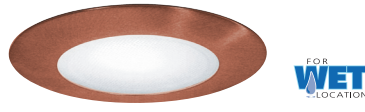

LENS:
ALBALITE

TRIM/RING FINISH:
WH, BK, SN, CP, CH,
PB, BZ

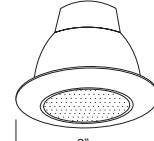

B705L
PLASTIC ALBALITE LENS



LENS:
ALBALITE

TRIM/RING FINISH:
WHITE PLASTIC

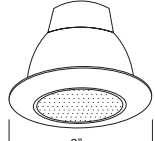

B706PB
METAL FRESNEL LENS



LENS:
FRESNEL

TRIM/RING FINISH:
WH, BK, SN, CP, CH,
PB, BZ

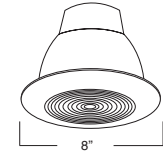

B706L
PLASTIC FRESNEL LENS



LENS:
FRESNEL

TRIM/RING FINISH:
WHITE PLASTIC



B707CP
METAL DROP OPAL LENS



LENS:
DROP OPAL

TRIM/RING FINISH:
WH, BK, SN, CP, CH,
PB, BZ

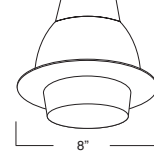

B707L
PLASTIC DROP OPAL LENS



LENS:
DROP OPAL

TRIM/RING FINISH:
WHITE PLASTIC

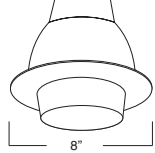

B743RG-WH
REFLECTOR W/ DROP OPAL LENS



REFLECTOR FINISH:
CL, RG, W, MB,
CP, SN

TRIM/RING FINISH:
WH, BK, SN, CP, CH,
PB, BZ

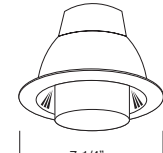

B756CL-WH
REFLECTOR W/ PRISMATIC LENS



REFLECTOR FINISH:
CL, RG, W, MB,
CP, SN

TRIM/RING FINISH:
WH, BK, SN, CP, CH,
PB, BZ

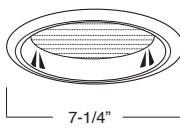

B741RG-WH
REFLECTOR W/ ALBALITE LENS



REFLECTOR FINISH:
CL, RG, W, MB,
CP, SN

TRIM/RING FINISH:
WH, BK, SN, CP, CH,
PB, BZ

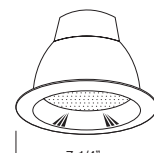

B742CL-WH
REFLECTOR W/ FRESNEL LENS



REFLECTOR FINISH:
CL, RG, W, MB,
CP, SN

TRIM/RING FINISH:
WH, BK, SN, CP, CH,
PB, BZ



B737W-WH
BAFFLE W/ DROP OPAL LENS



BAFFLE FINISH:
W, P, SN, CP, BZ

TRIM/RING FINISH:
WH, BK, SN, CP, CH,
PB, BZ

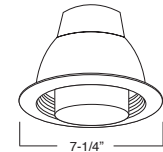

B755W-WH
BAFFLE W/ PRISMATIC LENS



BAFFLE FINISH:
W, P, SN, CP, BZ

TRIM/RING FINISH:
WH, BK, SN, CP, CH,
PB, BZ

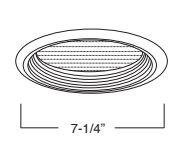

B735P-WH
BAFFLE W/ ALBALITE LENS

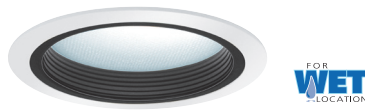

BAFFLE FINISH:
W, P, SN, CP, BZ

TRIM/RING FINISH:
WH, BK, SN, CP, CH,
PB, BZ

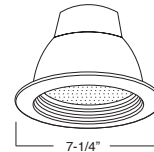

B736W-WH
BAFFLE W/ FRESNEL LENS



BAFFLE FINISH:
W, P, SN, CP, BZ

TRIM/RING FINISH:
WH, BK, SN, CP, CH,
PB, BZ



6" CFL Trims

(LAMP WATTAGE: UP TO 26W)

Catalog Number:

Project Name:

Type:

Note:



B757W-WH
BAFFLE W/ FROSTED DOME SHOWER LENS



BAFFLE FINISH:
W, P, SN, CP, BZ

TRIM/RING FINISH:
WH, BK, SN, CP, CH,
PB, BZ

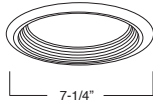

B758CL-WH
REFLECTOR W/ FROSTED DOME SHOWER LENS



REFLECTOR FINISH:
CL, RG, W, MB,
CP, SN

TRIM/RING FINISH:
WH, BK, SN, CP, CH,
PB, BZ



B760W-WH
BAFFLE W/ FROSTED LENS



BAFFLE FINISH:
W, P, SN, CP, BZ

TRIM/RING FINISH:
WH, BK, SN, CP, CH,
PB, BZ

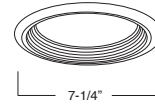

B759CL-WH
REFLECTOR W/ FROSTED LENS



REFLECTOR FINISH:
CL, RG, W, MB,
CP, SN

TRIM/RING FINISH:
WH, BK, SN, CP, CH,
PB, BZ

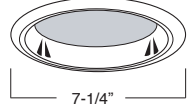

B781CP-WH
SQUARE BAFFLE TRIM



BAFFLE FINISH:
W, P, SN, CP, BZ

TRIM/RING FINISH:
WH, BK, SN, CP

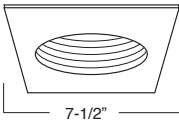

B787CP-WH
SQUARE REFLECTOR TRIM

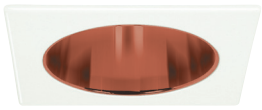

REFLECTOR FINISH:
CL, RG, W, MB,
SN, CP

TRIM/RING FINISH:
WH, BK, SN, CP

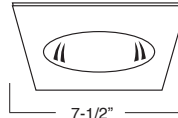

B782CL-W-WH
SQUARE REFLECTOR/BAFFLE TRIM

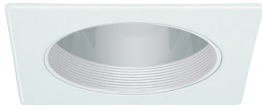

REFLECTOR FINISH:
CL

BAFFLE FINISH:
W, P

TRIM/RING FINISH:
WH, BK, SN, CP

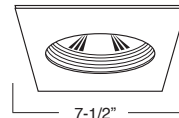

B788WH
SQUARE ALBALITE SHOWER LENS



LENS:
WHITE

TRIM/RING FINISH:
WH

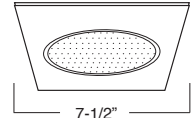

B785WH
SQUARE FRESNEL LENS



LENS:
FROSTED

TRIM/RING FINISH:
WH

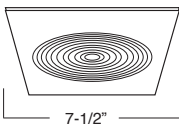

B796WH
SQUARE SMOOTH FROST DOME LENS



LENS:
FROSTED

TRIM/RING FINISH:
WH

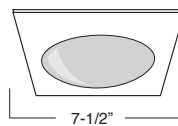

B780WH
SQUARE DESIGNER POINT LENS

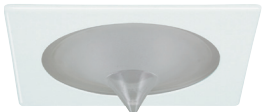

LENS:
FROSTED/CLEAR

TRIM/RING FINISH:
WH

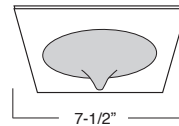

B789WH
SQUARE DESIGNER CONE LENS



LENS:
FROSTED

TRIM/RING FINISH:
WH

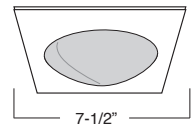

BAFFLE	REFLECTOR	TRIM RING
W White	CL Chrome	WH White
P Black	RG Gold	BK Black
SN Satin Nickel	W White	SN Satin Nickel
CP Copper	MB Black	CP Copper
BZ Bronze	CP Copper	CH Chrome
	SN Satin Nickel	PB Polish Brass
		BZ Bronze

*For custom baffle, reflector, trim ring, glass color and lens options, please consult factory.