

# B5PLRIC

## 5" Compact Fluorescent IC Remodel Housing

LAMP WATTAGE: UP TO 26W



DESIGNED FOR 2" X 8" JOIST CONSTRUCTION

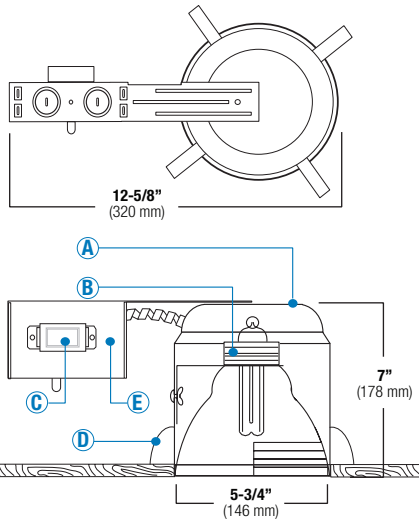

Catalog Number:

Project Name:

Type:

Note:



### DESCRIPTION

Thermally protected, IC rated specification grade remodel compact fluorescent recessed housing. For remodeling installations where housing will be in direct contact with insulation. Accommodates (1) 9W, 13W, 18W or 26W compact fluorescent lamp. For fast and easy installation in existing plaster or mechanical ceilings from 1/2" to 1-3/8" thick. Four remodel clips are easily retractable for fixture removal if necessary. Junction box is provided with eight 1/2" KOs and four Romex knockouts with strain relief.

### SPECIFICATION

**A. HOUSING** - Die-formed all aluminum construction for maximum heat dissipation and rust protection.

**B. SOCKET** - One vertically mounted plug-in socket. Unitized optics guarantees proper trim to housing installation. Tool-less installation adjusts from inside the housing.

**C. BALLAST** - Thermally protected, current controlled ballast, will produce full light output, increase lamp life with no noise and flicker. Ballast supplied is manufactured by Advance.

**D. INSTALLATION** - Four Preinstalled spring clips which secure the housing firmly into ceiling to accommodate ceiling thickness from 1/2" to 1-3/8".

**E. JUNCTION BOX** - feed through wiring provided with eight 1/2" KOs and four Romex knockouts with strain relief.

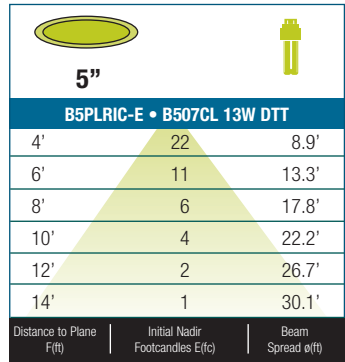

BEAM DIA. MEASURED AT 50% OF NADIR F.C.

### FEATURES

- Thermally Protected remodel compact fluorescent IC housing.
- Integral fluorescent ballast.
- Unit slips through 5-1/2" ceiling opening.
- Four Preinstalled spring clips which secure the housing firmly into ceiling to accommodate ceiling thickness from 1/2" to 1-3/8".
- Can be installed from below the ceiling.
- Wire through junction box.
- Dependable, favorable design and effortless installation.
- 7" height allows use in 2" x 8" joist construction.

### OPTIONS

#### AIR-SHUT

- Gasket to prevent air flow from heated or air conditioned spaces.
- Meets all national air flow requirements.



**B5PLRIC - ITEM SELECTOR:** (Please check the boxes below for the option desired)

WATTAGE	BALLAST	VOLTAGE	EMERGENCY OPTIONS	TRIM TYPE	BAFFLE	REFLECTOR	TRIM/RING	GLASS
<input type="checkbox"/> 9W	<input type="checkbox"/> (E) Electronic	<input type="checkbox"/> MVOLT (120/277)	<input type="checkbox"/> EMG 750 (750 Lumens) <sup>6</sup>	<input type="checkbox"/> B530 <input type="checkbox"/> B542	<input type="checkbox"/> W	<input type="checkbox"/> CL	<input type="checkbox"/> WH	<input type="checkbox"/> Green
<input type="checkbox"/> 13W	<input type="checkbox"/> (M) Magnetic <sup>1</sup>	<input type="checkbox"/> 120	<input type="checkbox"/> EMG 1300 (1300 Lumens) <sup>6</sup>	<input type="checkbox"/> B507 <input type="checkbox"/> B504L	<input type="checkbox"/> P	<input type="checkbox"/> RG	<input type="checkbox"/> BK	<input type="checkbox"/> Yellow
<input type="checkbox"/> 18W	<input type="checkbox"/> (S) Energy Star <sup>2</sup>	<input type="checkbox"/> 277	<input type="checkbox"/> EMG-D-750 (750 Lumens) <sup>7</sup>	<input type="checkbox"/> B565 <input type="checkbox"/> B501L	<input type="checkbox"/> SN	<input type="checkbox"/> W	<input type="checkbox"/> SN	<input type="checkbox"/> Pink
<input type="checkbox"/> 26W			<input type="checkbox"/> ICE-1300 (1300 Lumens) <sup>8</sup>	<input type="checkbox"/> B520 <input type="checkbox"/> B505L	<input type="checkbox"/> CP	<input type="checkbox"/> MB	<input type="checkbox"/> CP	<input type="checkbox"/> Brown
				<input type="checkbox"/> B525	<input type="checkbox"/> BZ	<input type="checkbox"/> BZ	<input type="checkbox"/> CH	<input type="checkbox"/> Navy Blue
				<input type="checkbox"/> B504		<input type="checkbox"/> CP	<input type="checkbox"/> PB	<input type="checkbox"/> Orange
				<input type="checkbox"/> B501		<input type="checkbox"/> SN	<input type="checkbox"/> BZ	<input type="checkbox"/> Blue
				<input type="checkbox"/> B505		<input type="checkbox"/> SHZ		<input type="checkbox"/> White
				<input type="checkbox"/> B535				<input type="checkbox"/> Red
				<input type="checkbox"/> B536				
				<input type="checkbox"/> B541				
	<b>DIMMING</b>	<b>AIR-SHUT</b>	<b>OTHER OPTIONS</b>					
	<input type="checkbox"/> Mark 7 <sup>3</sup>	<input type="checkbox"/> AT	<input type="checkbox"/> FUSE <sup>9</sup>					
	<input type="checkbox"/> Mark 10 <sup>4</sup>		<input type="checkbox"/> RIF <sup>10</sup>					
	<input type="checkbox"/> Lut-E (EC3D) <sup>5</sup>							
	<input type="checkbox"/> REB-DIM-120							

(Note: CA Title 24 approved only if ordered with electronic ballast and Air-Shut.) 1 - (M) Magnetic = Available only in 9W fixture and not available in MVOLT • 2 - (S) Energy Star = Available on selected fixtures only, please see list above • 3 - MARK 7 = Not available in 9W, 13W, 57W, 70W • 4 - MARK 10 = Not available in 9W, 13W, 57W, 70W, must specify voltage • 5 - LUT-E (EC3D) = Not available in 9W, 13W, 57W, 70W • 6 - EMG = Emergency battery pack w/ remote test switch • 7 - EMG-D = Emergency battery pack w/ remote test switch for damp location • 8 - ICE = Emergency battery pack w/ remote test switch operating between -18°C and 55°C • 9 - FUSE = Single slow-blow fuse • 10 - RIF = Radio interference filter

### Specifications:

**B5PLRIC**

WATT	BALLAST	VOLTAGE	AIR-SHUT	EMERGENCY	OPTIONS	TRIM TYPE	REFLECTOR	BAFFLE	RING	GLASS

BAFFLE	REFLECTOR	TRIM/RING
W White	CL Chrome	WH White
P Black	RG Gold	BK Black
SN Satin Nickel	W White	SN Satin Nickel
CP Copper	MB Black	CP Copper
BZ Bronze	BZ Bronze	CH Chrome
	CP Copper	PB Polish Brass
	SN Satin Nickel	BZ Bronze
	SHZ Satin Haze	

Sample of Catalog Number: B5PLRIC-26W-E-MVOLT-EMG750-B530W-WH

\*For custom baffle, reflector, trim ring, glass color and lens options, please consult factory.



Submittal form is available @ [www.iuseelite.com](http://www.iuseelite.com)  
Tel: 323-888-1973 • Fax: 323-888-1977

Specifications and Dimensions  
subject to change without notice.

REV: ELITE LIGHTING-SPEC-06-29-2011

# 5" CFL Trims

( LAMP WATTAGE: UP TO 26W )

Catalog Number:

Project Name:

Type:

Note:



**B530CP-CP  
STEPPED BAFFLE**



**AVAILABLE COLOR COMBINATIONS:**  
CP-CP, SN-SN, W-WH, P-WH, P-BK, BZ-BZ

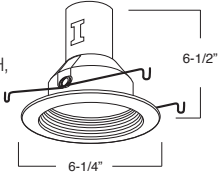

**B507RG-WH  
REFLECTOR**



**AVAILABLE COLOR COMBINATIONS:**  
CP-CP, W-WH, RG-WH, MB-WH, CL-WH, MB-BK, RG-PB, CL-CH

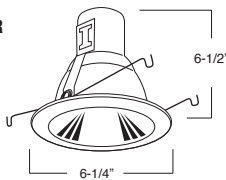

**B565W-CL  
CONE REFLECTOR WITH BAFFLE**



**AVAILABLE COLOR COMBINATIONS:**  
W-CL, P-CL, W-RG, P-RG

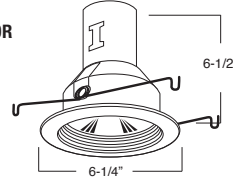

**B520-NAVY BLUE  
GLASS TRIM**



**GLASS FINISH:**  
GREEN, YELLOW, PINK, BROWN, NAVY BLUE, ORANGE, WHITE, RED

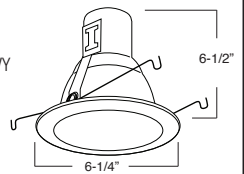

**B525W-WH  
BAFFLE WITH FROSTED DOME**



FOR WET LOCATION

**AVAILABLE COLOR COMBINATIONS:**  
CP-CP, SN-SN, W-WH, P-WH, P-BK

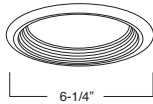

**B504WH  
SHOWER TRIM**



FOR WET LOCATION

**TRIM/RING FINISH:**  
WH, BK, SN, CP, CH, BZ

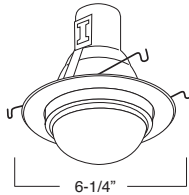

**B501CP  
METAL ALBALITE LENS**



FOR WET LOCATION

**TRIM/RING FINISH:**  
WH, BK, SN, CP, CH, BZ

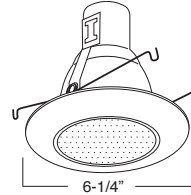

**B505SN  
METAL FRESNEL LENS**



FOR WET LOCATION

**TRIM/RING FINISH:**  
WH, BK, SN, CP, CH, BZ

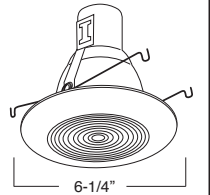

**B535P-WH  
BAFFLE WITH ALBALITE LENS**



FOR WET LOCATION

**AVAILABLE COLOR COMBINATIONS:**  
CP-CP, SN-SN, W-WH, P-WH, P-BK

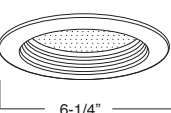

**B536W-WH  
BAFFLE WITH FRESNEL LENS**



FOR WET LOCATION

**AVAILABLE COLOR COMBINATIONS:**  
CP-CP, SN-SN, W-WH, P-WH, P-BK

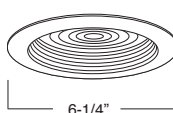

**B541RG-WH  
REFLECTOR WITH ALBALITE LENS**



FOR WET LOCATION

**AVAILABLE COLOR COMBINATIONS:**  
CP-CP, W-WH, RG-WH, MB-BK, CL-WH, MB-BK, RG-PB, CL-CH

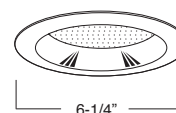

**B541CL-WH  
REFLECTOR WITH FRESNEL LENS**



FOR WET LOCATION

**AVAILABLE COLOR COMBINATIONS:**  
CP-CP, W-WH, RG-WH, MB-BK, CL-WH, MB-BK, RG-PB, CL-CH

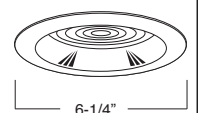

**B501L  
PLASTIC ALBALITE LENS**



FOR WET LOCATION

**TRIM/RING FINISH:**  
WHITE PLASTIC

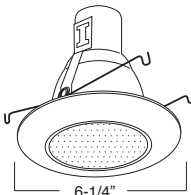

**B504L  
PLASTIC SHOWER TRIM**



FOR WET LOCATION

**TRIM/RING FINISH:**  
WHITE PLASTIC

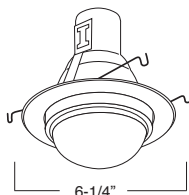

**B505L  
PLASTIC FRESNEL LENS**



FOR WET LOCATION

**TRIM/RING FINISH:**  
WHITE PLASTIC

