

B5PL

5" Compact Fluorescent Non-IC Housing

LAMP WATTAGE: UP TO 26W

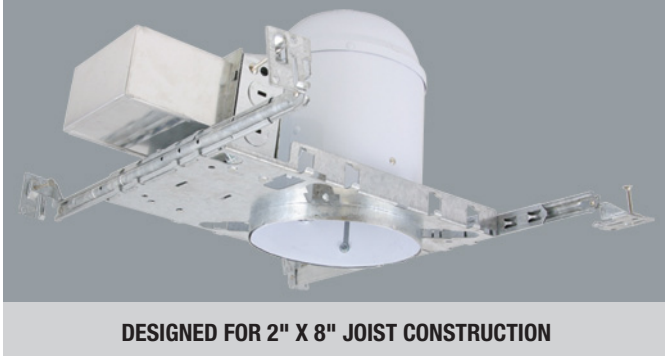

DESIGNED FOR 2" X 8" JOIST CONSTRUCTION

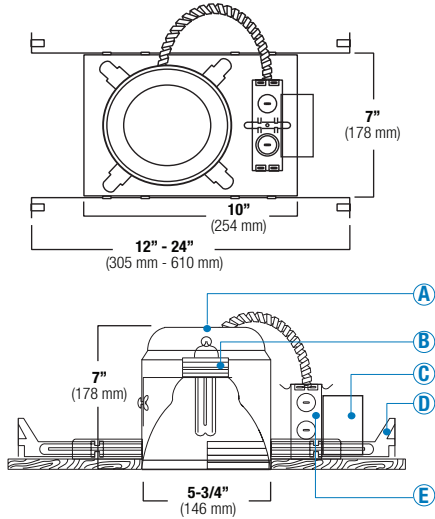

Catalog Number:

Project Name:

Type:

Note:



DESCRIPTION

Thermally protected, specification grade compact fluorescent housing. For new construction non-insulated ceilings or where insulation can be kept 3" from housing. Accommodates (1) 9W, 13W, 18W or 26W compact fluorescent lamp. Furnished with preinstalled adjustable bar hangers. Junction box is provided with four 1/2" KOs, one 3/4" KO and four Romex knockouts with strain relief.

SPECIFICATION

A. HOUSING - High temperature painted 22 gauge cold rolled steel construction for maximum heat dissipation and rust protection. Adjusts vertically in plaster frame to accommodate 1/2" to 1-3/8" ceiling.

B. SOCKET - One vertically mounted plug-in socket. Unit-sized optics guarantees proper trim to housing installation. Tool-less installation adjusts from inside the housing.

C. BALLAST - Thermally protected, current controlled ballast, will produce full light output, increase lamp life with no noise and flicker. Ballast supplied is manufactured by Advance.

D. BAR HANGERS - Preinstalled bar hangers allow housing to be positioned and locked at any point within a 24" joist span. They can be positioned on either the long or short axis of the housing and can be shortened for 12" joists. They contain a double-headed real nail for 20° downward angle for better contact, and the 90° pivoting mounting plate makes installation fast and accurate. Bar hangers can fit onto T-Bar spline with additional slots and holes for special mounting methods if necessary.

E. JUNCTION BOX - through-branch circuit wiring and has four 1/2" KOs, one 3/4" KO and four Romex knockouts with true pry-out slots and strain clamps.

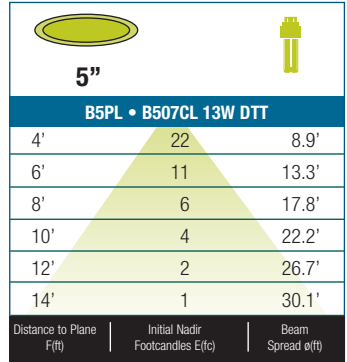

BEAM DIA. MEASURED AT 50% OF NADIR F.C.

FEATURES

- Thermally Protected compact fluorescent Non-IC housing.
- Integral fluorescent ballast.
- Wire through junction box.
- Preinstalled adjustable bar hanger.
- Dependable, favorable design and effortless installation.
- 7" height allows use in 2" x 8" joist construction.
- Special screw on the frame locks bar hangers in place which prevents the housing from any movement once installed.

OPTIONS

AIR-SHUT

- Gasket to prevent air flow from heated or air conditioned spaces.
- Meets all national air flow requirements.



B5PL - ITEM SELECTOR: (Please check the boxes below for the option desired)

WATTAGE	BALLAST	VOLTAGE	EMERGENCY OPTIONS	TRIM TYPE	BAFFLE	REFLECTOR	TRIM/RING	GLASS
<input type="checkbox"/> 9W	<input type="checkbox"/> (E) Electronic	<input type="checkbox"/> MVOLT (120/277)	<input type="checkbox"/> EMG 750 (750 Lumens) ⁶	<input type="checkbox"/> B530 <input type="checkbox"/> B542	<input type="checkbox"/> W	<input type="checkbox"/> CL	<input type="checkbox"/> WH	<input type="checkbox"/> Green
<input type="checkbox"/> 13W	<input type="checkbox"/> (M) Magnetic ¹	<input type="checkbox"/> 120	<input type="checkbox"/> EMG 1300 (1300 Lumens) ⁶	<input type="checkbox"/> B507 <input type="checkbox"/> B504L	<input type="checkbox"/> P	<input type="checkbox"/> RG	<input type="checkbox"/> BK	<input type="checkbox"/> Yellow
<input type="checkbox"/> 18W	<input type="checkbox"/> (S) Energy Star ²	<input type="checkbox"/> 277	<input type="checkbox"/> EMG-D-750 (750 Lumens) ⁷	<input type="checkbox"/> B565 <input type="checkbox"/> B501L	<input type="checkbox"/> SN	<input type="checkbox"/> W	<input type="checkbox"/> SN	<input type="checkbox"/> Pink
<input type="checkbox"/> 26W		<input type="checkbox"/> 347	<input type="checkbox"/> ICE-1300 (1300 Lumens) ⁸	<input type="checkbox"/> B520 <input type="checkbox"/> B505L	<input type="checkbox"/> CP	<input type="checkbox"/> MB	<input type="checkbox"/> CP	<input type="checkbox"/> Brown
	DIMMING	AIR-SHUT	OTHER OPTIONS	<input type="checkbox"/> B525	<input type="checkbox"/> BZ	<input type="checkbox"/> BZ	<input type="checkbox"/> CH	<input type="checkbox"/> Navy Blue
	<input type="checkbox"/> Mark 7 ³	<input type="checkbox"/> AT	<input type="checkbox"/> FUSE ⁹	<input type="checkbox"/> B504		<input type="checkbox"/> CP	<input type="checkbox"/> PB	<input type="checkbox"/> Orange
	<input type="checkbox"/> Mark 10 ⁴		<input type="checkbox"/> RIF ¹⁰	<input type="checkbox"/> B501		<input type="checkbox"/> SN	<input type="checkbox"/> BZ	<input type="checkbox"/> Blue
	<input type="checkbox"/> Lut-E (EC3D) ⁵			<input type="checkbox"/> B505		<input type="checkbox"/> SHZ		<input type="checkbox"/> White
	<input type="checkbox"/> REB-DIM-120			<input type="checkbox"/> B535				<input type="checkbox"/> Red
				<input type="checkbox"/> B536				
				<input type="checkbox"/> B541				

¹ - (M) Magnetic = Available only in 9W fixture and not available in MVOLT • ² - (S) Energy Star = Available on selected fixtures only, please see list above • ³ - MARK 7 = Not available in 9W, 13W, 57W, 70W • ⁴ - MARK 10 = Not available in 9W, 13W, 57W, 70W, must specify voltage • ⁵ - LUT-E (EC3D) = Not available in 9W, 13W, 57W, 70W • ⁶ - EMG = Emergency battery pack w/ remote test switch • ⁷ - EMG-D = Emergency battery pack w/ remote test switch for damp location • ⁸ - ICE = Emergency battery pack w/ remote test switch operating between -18°C and 55°C • ⁹ - FUSE = Single slow-blow fuse • ¹⁰ - RIF = Radio interference filter

Specifications:

B5PL

WATT	BALLAST	VOLTAGE	AIR-SHUT	EMERGENCY	OPTIONS	TRIM TYPE	REFLECTOR	BAFFLE	RING	GLASS
------	---------	---------	----------	-----------	---------	-----------	-----------	--------	------	-------

BAFFLE	REFLECTOR	TRIM/RING
W White	CL Chrome	WH White
P Black	RG Gold	BK Black
SN Satin Nickel	W White	SN Satin Nickel
CP Copper	MB Black	CP Copper
BZ Bronze	BZ Bronze	CH Chrome
	CP Copper	PB Polish Brass
	SN Satin Nickel	BZ Bronze
	SHZ Satin Haze	

Sample of Catalog Number: B5PL-26W-E-MVOLT-EMG750-B530W-WH

*For custom baffle, reflector, trim ring, glass color and lens options, please consult factory.



Submittal form is available @ www.iuseelite.com
Tel: 323-888-1973 • Fax: 323-888-1977

Specifications and Dimensions subject to change without notice.

REV: ELITE LIGHTING-SPEC-06-29-2011

5" CFL Trims

(LAMP WATTAGE: UP TO 26W)

Catalog Number:

Project Name:

Type:

Note:



**B530CP-CP
STEPPED BAFFLE**



AVAILABLE COLOR COMBINATIONS:
CP-CP, SN-SN, W-WH, P-WH, P-BK, BZ-BZ

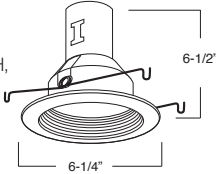

**B507RG-WH
REFLECTOR**



AVAILABLE COLOR COMBINATIONS:
CP-CP, W-WH, RG-WH, MB-WH, CL-WH, MB-BK, RG-PB, CL-CH

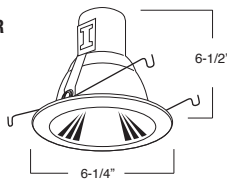

**B565W-CL
CONE REFLECTOR WITH BAFFLE**

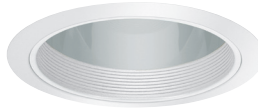

AVAILABLE COLOR COMBINATIONS:
W-CL, P-CL, W-RG, P-RG

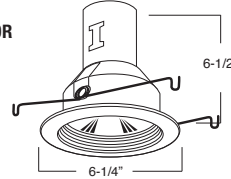

**B520-NAVY BLUE
GLASS TRIM**



GLASS FINISH:
GREEN, YELLOW, PINK, BROWN, NAVY BLUE, ORANGE, WHITE, RED

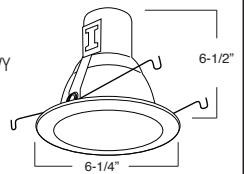

**B525W-WH
BAFFLE WITH FROSTED DOME**



FOR WET LOCATION

AVAILABLE COLOR COMBINATIONS:
CP-CP, SN-SN, W-WH, P-WH, P-BK

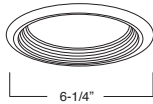

**B504WH
SHOWER TRIM**



FOR WET LOCATION

TRIM/RING FINISH:
WH, BK, SN, CP, CH, BZ

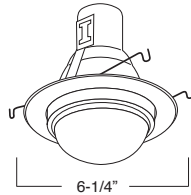

**B501CP
METAL ALBALITE LENS**



FOR WET LOCATION

TRIM/RING FINISH:
WH, BK, SN, CP, CH, BZ

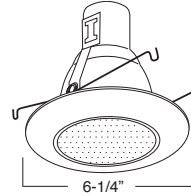

**B505SN
METAL FRESNEL LENS**



FOR WET LOCATION

TRIM/RING FINISH:
WH, BK, SN, CP, CH, BZ

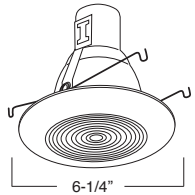

**B535P-WH
BAFFLE WITH ALBALITE LENS**



FOR WET LOCATION

AVAILABLE COLOR COMBINATIONS:
CP-CP, SN-SN, W-WH, P-WH, P-BK

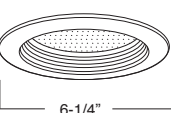

**B536W-WH
BAFFLE WITH FRESNEL LENS**



FOR WET LOCATION

AVAILABLE COLOR COMBINATIONS:
CP-CP, SN-SN, W-WH, P-WH, P-BK

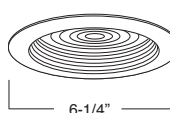

**B541RG-WH
REFLECTOR WITH ALBALITE LENS**



FOR WET LOCATION

AVAILABLE COLOR COMBINATIONS:
CP-CP, W-WH, RG-WH, MB-BK, CL-WH, MB-BK, RG-PB, CL-CH

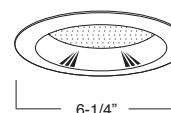

**B541CL-WH
REFLECTOR WITH FRESNEL LENS**



FOR WET LOCATION

AVAILABLE COLOR COMBINATIONS:
CP-CP, W-WH, RG-WH, MB-BK, CL-WH, MB-BK, RG-PB, CL-CH

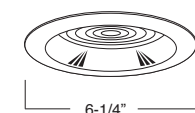

**B501L
PLASTIC ALBALITE LENS**



FOR WET LOCATION

TRIM/RING FINISH:
WHITE PLASTIC

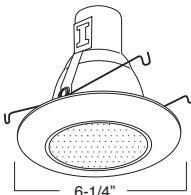

**B504L
PLASTIC SHOWER TRIM**



FOR WET LOCATION

TRIM/RING FINISH:
WHITE PLASTIC

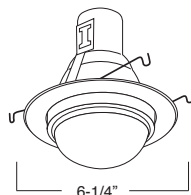

**B505L
PLASTIC FRESNEL LENS**



FOR WET LOCATION

TRIM/RING FINISH:
WHITE PLASTIC

