

T5 LOW PROFILE FLUORESCENT STAGGERED COVE LUMINAIRE (2 LAMP T5)

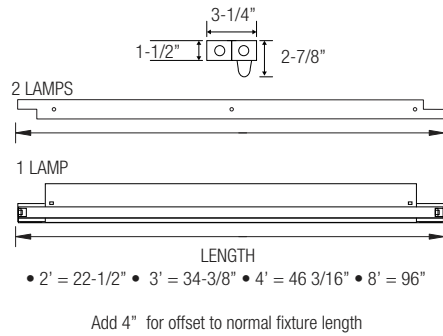
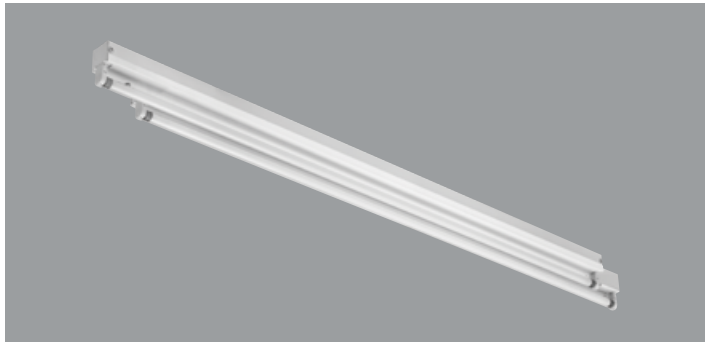

APPLICATION:

Staggered lamp fixtures are designed for use in cove, recessed slot, or luminous ceiling applications. Staggering the lamps provides for uniform illumination that eliminates shadows and/or hot spots: • Lobbies • Restaurants • Restrooms • Office buildings • Hallways • Airports • Retail spaces • Conference rooms

PRODUCT FEATURES:

- Combine various fixture lengths for row configurations
- Fixture channel is offset in order to provide smooth illumination without shadowing
- Die-formed, code-gauge, cold-rolled steel
- Post-painted to insure against exposed metal surfaces
- Pretreated with five-stage iron phosphate process to ensure superior paint adhesion
- Shallow design is ideal for commercial spaces requiring cove illumination
- Suitable for dry and damp environments
- Thermally protected, self-resetting, Class P, NPF, non-PCB and UL listed ballast
- Individual or continuous row mounting
- NEC required ballast disconnect is standard

LISTING

UL/C-UL listed to US and Canadian standard

WARRANTY

Guaranteed for one year against mechanical defects

T5
OSTG

Ordering Information > Example: 3-OSTG-2-21-T5-MVOLT-EMG-T5-T5HO-700

3	OSTG	2						
FIXTURE SIZE	SERIES	LAMPS	WATTAGE		VOLTAGE¹	# OF BALLAST	BALLAST FACTOR	
3- 3'	OSTG- Oracle Staggered Strip	2	3' FIXTURE 21-T5 (21W/T5) 39-T5HO (39W/T5HO)		(Blank)- MVOLT (120/277) 120 277 347	(Blank)- 1 Ballast 2- 2 Ballasts	(Blank)- Normal BF HBF- High BF LBF- Low BF	

BALLAST CONFIGURATION & CODE		
21W/T5	39W/T5HO	DESCRIPTION
-	-	Electronic Instant Start
(Blank)	(Blank)	Electronic Program Start
-	-	Advance Mark-7 ¹
-	-	Advance Mark-10 ¹
-	-	Advance Optanium ¹
-	-	Advance Essential ¹
-	-	Advance Rover ¹
-	-	Lutron Ecosystem H-Series ¹
-	-	Lutron Tu-Wire ¹
LUT-EC5	LUT-EC5	Lutron Ecosystem ¹
LUT-EC3	-	Lutron Eco-10 ¹
-	-	Lutron Tve ¹
LUT-H3D	LUT-H3D	Lutron Hi-Lume 3D ¹
-	-	Lutron Ecosystem (347V Only) ¹

¹- Voltage must be specified for dimming ballast.

REMOTE EMERGENCY BATTERY PACK OPTIONS (L. = LUMENS)	
ORDER CODE	DESCRIPTION
EMG-T5-T5HO-700	Up to 700 L. for T5 or T5HO
EMG-T5-T5HO-1300	Up to 1300 L. for T5 or T5HO
EMG-T8-BX-T5-T5HO-3200	Up to 3200 L. for T8, BX, T5 or T5HO
EMG-SD-T8-BX-T5-T5HO-1400	Self-Diagnostic 1400 L. for T8, BX, T5 or T5HO
EMG-ICE-T8-BX-T5-T5HO-1400	ICE Pack 1400 L. for T8, BX, T5 or T5HO
GTD	Generator Transfer Device

WIRING OPTIONS	
C3	- 6' 3-wire Flex Cable (Single Circuit)
C4	- 6' 4-wire Flex Cable (Double Circuit)
FBF	- Internal Fast Blow Fuse
SBF	- Internal Slow-Blow Fuse
RIS	- Radio Interference Suppressor

OTHER OPTIONS	
USA	- Made in America Compliance

REFLECTOR OPTIONS
Refer to page 275

3' Low Profile Fluorescent Staggered