

FG-Full Offset Grid

EASY COLORS  
**SELECTOR**  
MULTI-LUMEN  
SELECTOR

**DIMENSIONS**

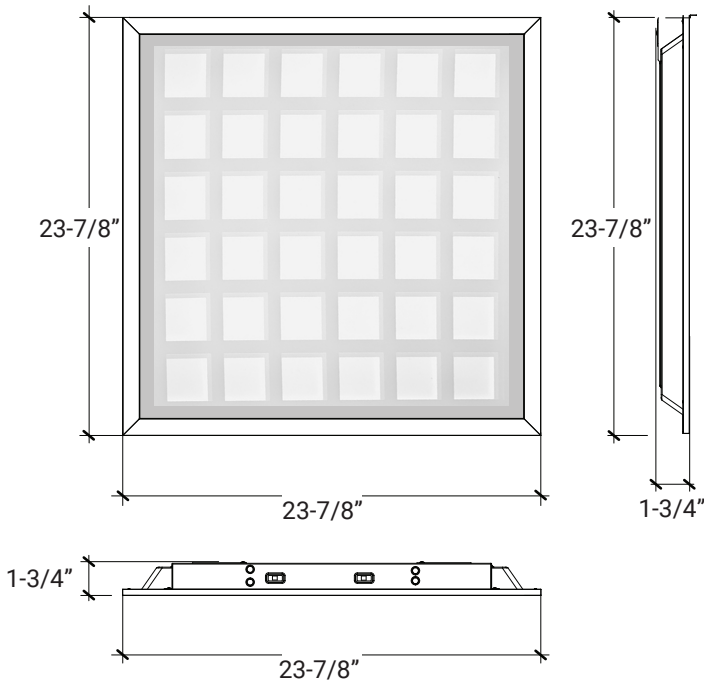

**FEATURES**

The clean design of the **Fully Luminous Decorative Troffer** transforms your lighting projects into a masterpiece of art.

This **unique 3D optical pattern** is a contemporary alternative to traditional fluorescent troffers. The **22-OAT3D-LED-FG design** delivers unmatched uniform light distribution.

Easily adjust brightness levels (**multi-lumen**) and color options (**multi-CCT**) in the field with multi-lumen and multi-CCT selectors. Perfect for **offices, schools, healthcare, hospitals, retail**, among other applications.

**4000/5000/6000**

NOMINAL LUMENS	DELIVERED LUMENS	WATTAGE
6000	5694	50W
5000	4910	41W
4000	3831	30W

Based on 4000K, 85+ CRI. Actual wattage may vary +/- 5%

**2000/3000/4000/5000**

NOMINAL LUMENS	DELIVERED LUMENS	WATTAGE
5000	4910	41W
4000	4536	37W
3000	3538	28W
2000	2591	19W

Based on 4000K, 85+ CRI. Actual wattage may vary +/- 5%

**2000/3000/4000**

NOMINAL LUMENS	DELIVERED LUMENS	WATTAGE
4000	4536	37W
3000	3538	28W
2000	2591	19W

Based on 4000K, 85+ CRI. Actual wattage may vary +/- 5%

**TECHNICAL DETAILS**

<b>LUMENS</b>	2000L/ 3000L/ 4000L   2000L/ 3000L/ 4000L/ 5000L 4000L/ 5000L/ 6000L   5000L/ 6000L/ 7000L
<b>CCT</b>	35K/40K/50K 30K/35K/40K 30K/35K/40K/50K
<b>CRI</b>	85+
<b>UGR</b>	<19
<b>COLOR QUALITY</b>	3 Step MacAdam Ellipse

<b>SIZE</b>	2'X2'
<b>MOUNTING</b>	Recessed, Suspended, Surface Mount
<b>DIMMING</b>	0-10V Flicker Free 10% Dimming Standard (Dim10)
<b>EMERGENCY</b>	10W-Up to 1000L output, 20W-Up to 2000L output
<b>LIFETIME</b>	L70 at 60,000 Hours
<b>PHOTOMETRIC TST</b>	In accordance with IES LM79-08, LM80 & TM30, TM21

**MAINTENANCE**

Luminaire can be regularly and safely wipe down to ensure the peak of performance.

**OPTICAL SYSTEM**

Clear acrylic 0.125" matte PMMA, in 18 different 3D graphic image printed on inside lens surface, which protects it from cleaning solutions with scratch and impact resistant lens. Illumination is spread across the entire surface of the Architectural Panel, emitting soft, even light. A 110-degree beam angle ensures clear, shadow-free light.

**CONSTRUCTION**

Narrow extruded aluminum is tightly held to code gauge steel back plate with seamless corners to maximize the light emitting surface with a refined finish. Acrylic Architectural Lens technology enables a wide-variety of 3D visual forms; all on an easy-to-clean flat surface.

**MOUNTING**

Easy to install. Mounting hardware included. Accommodates lay-in ceilings, Slot T, and T bar suspension systems for 5/8" and 3/8" ceiling widths. Built-in grid and earthquake clips come standard. Options for flange kits, surface mounted kits and more. SMK required if suspending the fixture.

**OPTIONS**

Luminaires can be shipped pre-installed with whips, modular wiring systems.

**DRIVER ELECTRICAL INFORMATION**

Powered by high-quality constant-current power LED drivers which are rated for 50 to 60Hz at 120/277V input provides noise free operation. Available in 347V; produce less than 20% THD, and have a power factor of .90 to 1.00.

**CONTROL OPTION**

Compatible with field installed wireless controls such as daylight harvesting controls, occupancy sensors, and/or power packs for individual or room control applications

**LED and PERFORMANCE**

The Mid power LED array provides an uniform source with high efficiency and no pixilation in +85 CRI minimum, R9 greater than 12 with 3 SDCM. The color Temperature (CCT) and Lumen has a selectable range from 3000K to 5000K color temperature and 2000 to 6000 lumen with 2 separate side mount slide switch located in the back of the luminaire.

**DIMMING & DRIVER INFORMATION**

**DIM10** - Flicker Free and continuous 10% Dimming Standard (DIM10) 0-10V dimming on either MVOLT 120, 277V and 347V

**WARRANTY**

Five-year warranty for parts and components. (Labor not included)

**LISTINGS**

c-UL-us - Listed for Feed Through Wiring.

Can be used to comply with Tittle 24, non residential lighting requirements.

Damp location rated.

For DesignLights Consortium® (DLC) qualified products please visit [www.designlights.org](http://www.designlights.org). Not all family members will be listed for DLC Premium or DLC Standard.

Example: 22-OAT3D-LED-FG-2000L/3000L/4000L-DIM10-120-347V-30K/35K/40K-85

SERIES	LUMENS	DIMMING	VOLTAGE	CCT	CRI	EMERGENCY	OTHER OPTIONS
22-OAT3D-LED	2000L/3000L/4000L	DIM10	MVOLT	35K/40K/50K	85	0-EMG-LED-10W	22FK - 2'x2' Flange Kit
	4000L/5000L/6000L	DIM10	MVOLT	35K/40K/50K		0-EMG-LED-20W	22-OAT3D-LED-SMK - 2'x2' Surface Mount Kit
	2000L/3000L/4000L/5000L	DIM10	MVOLT	30K/35K/40K/50K			USA - Made in America
	5000L/6000L/7000L	DIM10	MVOLT	30K/35K/40K/50K			Compliance
	2000L/3000L/4000L/5000L	DIM10	120-347V	30K/35K/40K/50K			
	2000L/3000L/4000L	DIM10	120-347V	30K/35K/40K			
	4000L/5000L/6000L	DIM10	120-347V	30K/35K/40K			

LENS  
FG-Full Offset Grid



**22-OAT3D-LED-2000L-3000L-4000L-DIM10-MVOLT-35K-40K-50K-85(2000L)**

TEST NO.: **EL05212049**

INPUT WATTS: **19.4949**

LUMENS: **2597**

CRI: **N/A**

EFFICACY: **133**

CCT: **3500K**

SPACING CRITERIA: **1.42**

**Candle Power Distribution (Candelas)**

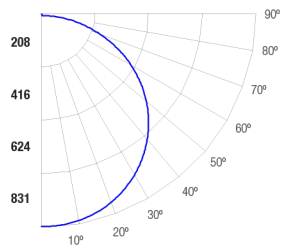

**Zonal Lumens Summary**

Zone	Lumens	%Lamp	%Fixt
0-20	305.14	11.70	11.70
0-30	652.69	25.10	25.10
0-40	1079.38	41.60	41.60
0-60	1954.11	75.20	75.20
0-80	2497.12	96.20	96.20
0-90	2571.01	99.00	99.00

**Luminance (Average candela/M<sup>2</sup>)**

Angle in Degrees	Average		
	0°	45°	90°
45	2226	2269	2283
55	2200	2262	2282
65	2136	2227	2256
75	2018	2162	2200
85	1945	2331	2444

**Lumens Per Zone**

Zone	Lumens
0-10	78.62
10-20	226.53
20-30	347.55
30-40	426.69
40-50	453.11
50-60	421.62
60-70	334.88
70-80	208.13
80-90	73.89

**Candela Tabulation**

0	
0.0	829.942
5.0	827.490
15.0	802.200
25.0	753.010
35.0	680.450
45.0	585.350
55.0	469.270
65.0	335.710
75.0	194.290
85.0	63.040
90.0	10.750

**Coefficients of Utilization - Zonal Cavity Method**

Effective Floor Cavity Reflectance 0.20

RC	RW	80%				70%				50%			30%			10%			0%
		70%	50%	30%	10%	70%	50%	30%	10%	50%	30%	10%	50%	30%	10%	50%	30%	10%	0%
0	119	119	119	119	119	116	116	116	116	111	111	111	106	106	106	101	101	101	99
1	108	103	98	94	105	100	96	92	96	92	89	92	89	86	88	86	84	81	
2	98	89	82	76	95	87	80	75	83	78	73	80	75	71	77	73	69	67	
3	89	78	69	62	86	76	68	62	73	66	61	70	64	59	67	62	58	56	
4	81	69	60	53	79	67	59	52	65	57	51	62	56	50	60	54	50	47	
5	74	61	52	45	72	60	51	45	58	50	44	56	49	44	54	48	43	41	
6	69	55	46	39	67	54	45	39	52	44	38	50	43	38	48	42	38	35	
7	64	50	41	34	62	49	40	34	47	39	34	46	39	34	44	38	33	31	
8	59	45	37	31	57	45	36	30	43	36	30	42	35	30	40	34	30	28	
9	55	41	33	27	54	41	33	27	40	32	27	38	32	27	37	31	27	25	
10	52	38	30	25	50	38	30	25	37	29	25	36	29	24	35	29	24	22	

RC - Ceiling Cavity Reflectance RW - Wall Reflectance

**22-OAT3D-LED-2000L-3000L-4000L-DIM10-MVOLT-35K-40K-50K-85(3000L)**

TEST NO.: **EL05212050**

INPUT WATTS: **28.8**

LUMENS: **3638**

CRI: **N/A**

EFFICACY: **126**

CCT: **3500K**

SPACING CRITERIA: **1.42**

**Candle Power Distribution (Candelas)**

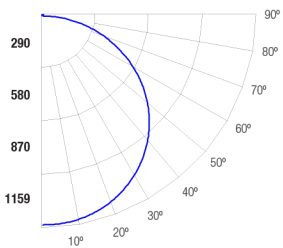

**Zonal Lumens Summary**

Zone	Lumens	%Lamp	%Fixt
0-20	424.85	11.70	11.70
0-30	908.79	25.00	25.00
0-40	1503.04	41.30	41.30
0-60	2730.86	75.10	75.10
0-80	3496.32	96.10	96.10
0-90	3600.78	99.00	99.00

**Luminance (Average candela/M<sup>2</sup>)**

Angle in Degrees	Average		
	0°	45°	90°
45	3096	3153	3181
55	3061	3143	3184
65	2971	3094	3150
75	2838	3033	3117
85	2711	3244	3469

**Lumens Per Zone**

Zone	Lumens
0-10	109.45
10-20	315.39
20-30	483.94
30-40	594.25
40-50	635.45
50-60	592.37
60-70	470.92
70-80	294.54
80-90	104.46

**Candela Tabulation**

0	
0.0	1155.504
5.0	1152.370
15.0	1116.480
25.0	1048.560
35.0	947.260
45.0	814.280
55.0	653.000
65.0	467.050
75.0	273.200
85.0	87.900
90.0	14.460

**Coefficients of Utilization - Zonal Cavity Method**

Effective Floor Cavity Reflectance 0.20

RC	RW	80%				70%				50%			30%			10%			0%
		70%	50%	30%	10%	70%	50%	30%	10%	50%	30%	10%	50%	30%	10%	50%	30%	10%	0%
0	119	119	119	119	116	116	116	116	111	111	111	106	106	106	101	101	101	99	
1	108	103	98	94	105	100	96	92	96	92	89	92	89	86	88	86	84	81	
2	98	89	82	76	95	87	80	75	83	78	73	80	75	71	76	73	69	67	
3	89	78	69	62	86	76	68	62	73	66	60	70	64	59	67	62	58	56	
4	81	69	59	52	79	67	59	52	64	57	51	62	56	50	60	54	50	47	
5	74	61	52	45	72	60	51	45	58	50	44	55	49	43	53	48	43	41	
6	68	55	46	39	66	54	45	39	52	44	38	50	43	38	48	42	37	35	
7	63	50	41	34	62	49	40	34	47	39	34	45	39	33	44	38	33	31	
8	59	45	36	30	57	44	36	30	43	35	30	42	35	30	40	34	30	28	
9	55	41	33	27	54	41	33	27	39	32	27	38	32	27	37	31	27	25	
10	52	38	30	25	50	38	30	25	36	29	24	35	29	24	35	28	24	22	

RC - Ceiling Cavity Reflectance RW - Wall Reflectance

**22-OAT3D-LED-2000L-3000L-4000L-DIM10-MVOLT-35K-40K-50K-85(4000L)**

TEST NO.: **EL05212051**

INPUT WATTS: **37.4**

LUMENS: **4536**

CRI: **N/A**

EFFICACY: **121**

CCT: **3500K**

SPACING CRITERIA: **1.42**

**Candle Power Distribution (Candelas)**

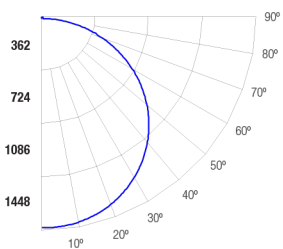

**Zonal Lumens Summary**

Zone	Lumens	%Lamp	%Fixt
0-20	530.24	11.70	11.70
0-30	1134.29	25.00	25.00
0-40	1876.05	41.40	41.40
0-60	3402.22	75.00	75.00
0-80	4358.49	96.10	96.10
0-90	4489.77	99.00	99.00

**Luminance (Average candela/M<sup>2</sup>)**

Angle in Degrees	Average		
	0°	45°	90°
45	3865	3938	3974
55	3820	3925	3981
65	3708	3862	3940
75	3544	3783	3918
85	3384	4051	4368

**Lumens Per Zone**

Zone	Lumens
0-10	136.60
10-20	393.64
20-30	604.05
30-40	741.77
40-50	788.05
50-60	738.12
60-70	588.50
70-80	367.77
80-90	131.28

**Candela Tabulation**

0	
0.0	1441.952
5.0	1437.640
15.0	1393.830
25.0	1308.550
35.0	1182.000
45.0	1016.650
55.0	814.920
65.0	582.820
75.0	341.150
85.0	109.710
90.0	18.020

**Coefficients of Utilization - Zonal Cavity Method**

Effective Floor Cavity Reflectance 0.20

RC	RW	80%				70%				50%			30%			10%			0%
		70%	50%	30%	10%	70%	50%	30%	10%	50%	30%	10%	50%	30%	10%	50%	30%	10%	0%
0	119	119	119	119	116	116	116	116	111	111	111	106	106	106	101	101	101	99	
1	108	103	98	94	105	100	96	92	96	92	89	92	89	86	88	86	83	81	
2	98	89	82	76	95	87	80	75	83	78	73	80	75	71	76	73	69	67	
3	89	78	69	62	86	76	68	62	73	66	60	70	64	59	67	62	58	56	
4	81	68	59	52	79	67	59	52	64	57	51	62	56	50	60	54	50	47	
5	74	61	52	45	72	60	51	45	58	50	44	55	49	43	53	48	43	41	
6	68	55	46	39	66	54	45	39	52	44	38	50	43	38	48	42	37	35	
7	63	50	41	34	62	49	40	34	47	39	34	45	39	33	44	38	33	31	
8	59	45	36	30	57	44	36	30	43	35	30	42	35	30	40	34	30	28	
9	55	41	33	27	54	41	33	27	39	32	27	38	32	27	37	31	27	25	
10	52	38	30	25	50	38	30	25	36	29	24	35	29	24	35	28	24	22	

**22-OAT3D-LED-4000L-5000L-6000L-DIM10-120-347V-35K-40K-50K-85(4000L)**

TEST NO.: **EL1005209**

INPUT WATTS: **30.9**

LUMENS: **3831**

CRI: **N/A**

EFFICACY: **124**

CCT: **3500K**

SPACING CRITERIA: **1.42**

**Candle Power Distribution (Candelas)**

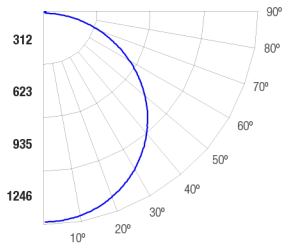

**Zonal Lumens Summary**

Zone	Lumens	%Lamp	%Fixt
0-20	453.15	11.80	11.80
0-30	967.59	25.30	25.30
0-40	1596.68	41.70	41.70
0-60	2886.68	75.40	75.40
0-80	3686.49	96.20	96.20
0-90	3793.1	99.00	99.00

**Luminance (Average candela/M<sup>2</sup>)**

Angle in Degrees	Average			
	0°	45°	90°	
45	3271	3269	3269	
55	3223	3217	3219	
65	3134	3117	3113	
75	3014	2990	2967	
85	2906	2871	2850	

**Lumens Per Zone**

Zone	Lumens
0-10	116.90
10-20	336.25
20-30	514.44
30-40	629.10
40-50	668.76
50-60	621.24
60-70	492.13
70-80	307.68
80-90	106.61

**Candela Tabulation**

0	
0.0	1234.645
5.0	1232.700
15.0	1192.190
25.0	1116.330
35.0	1005.990
45.0	860.200
55.0	687.700
65.0	492.620
75.0	290.170
85.0	94.200
90.0	12.930

**Coefficients of Utilization - Zonal Cavity Method**  
Effective Floor Cavity Reflectance 0.20

RC	RW	80%				70%				50%			30%			10%			0%
		70%	50%	30%	10%	70%	50%	30%	10%	50%	30%	10%	50%	30%	10%	50%	30%	10%	0%
0	119	119	119	119	116	116	116	116	111	111	111	106	106	106	101	101	101	99	
1	108	103	98	94	105	100	96	92	96	92	89	92	89	86	88	86	84	81	
2	98	89	82	76	95	87	80	75	83	78	73	80	75	71	77	73	69	67	
3	89	78	69	63	86	76	68	62	73	66	61	70	64	59	67	62	58	56	
4	81	69	60	53	79	67	59	52	65	57	51	62	56	51	60	54	50	47	
5	74	61	52	45	72	60	51	45	58	50	44	56	49	44	54	48	43	41	
6	69	55	46	39	67	54	45	39	52	44	39	50	43	38	49	42	38	36	
7	64	50	41	35	62	49	40	34	47	40	34	46	39	34	44	38	33	31	
8	59	45	37	31	57	45	36	31	43	36	30	42	35	30	41	34	30	28	
9	55	42	33	28	54	41	33	27	40	32	27	39	32	27	37	31	27	25	
10	52	38	30	25	50	38	30	25	37	30	25	36	29	24	35	29	24	23	

RC - Ceiling Cavity Reflectance RW - Wall Reflectance

**22-OAT3D-LED-4000L-5000L-6000L-DIM10-120-347V-35K-40K-50K-85(5000L)**

TEST NO.: **EL1005209**

INPUT WATTS: **41.5**

LUMENS: **4910**

CRI: **N/A**

EFFICACY: **118**

CCT: **3500K**

SPACING CRITERIA: **1.42**

**Candle Power Distribution (Candelas)**

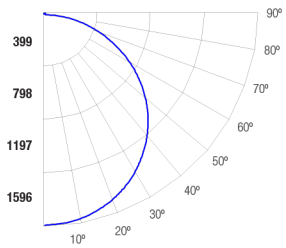

**Zonal Lumens Summary**

Zone	Lumens	%Lamp	%Fixt
0-20	582.38	11.90	11.90
0-30	1243.39	25.30	25.30
0-40	2051.59	41.80	41.80
0-60	3700.14	75.40	75.40
0-80	4725.16	96.20	96.20
0-90	4861.42	99.00	99.00

**Luminance (Average candela/M<sup>2</sup>)**

Angle in Degrees	Average			
	0°	45°	90°	
45	4184	4194	4208	
55	4121	4122	4143	
65	3994	3992	4015	
75	3826	3817	3814	
85	3600	3657	3723	

**Lumens Per Zone**

Zone	Lumens
0-10	150.20
10-20	432.18
20-30	661.02
30-40	808.19
40-50	854.13
50-60	794.42
60-70	631.59
70-80	393.44
80-90	136.26

**Candela Tabulation**

0	
0.0	1586.679
5.0	1582.040
15.0	1531.540
25.0	1431.370
35.0	1288.010
45.0	1100.460
55.0	879.260
65.0	627.780
75.0	368.320
85.0	116.720
90.0	14.070

**Coefficients of Utilization - Zonal Cavity Method**  
Effective Floor Cavity Reflectance 0.20

RC	RW	80%				70%				50%			30%			10%			0%
		70%	50%	30%	10%	70%	50%	30%	10%	50%	30%	10%	50%	30%	10%	50%	30%	10%	0%
0	119	119	119	119	116	116	116	116	111	111	111	106	106	106	101	101	101	99	
1	108	103	98	94	105	100	96	92	96	92	89	92	89	86	88	86	84	81	
2	98	89	82	76	95	87	80	75	83	78	73	80	75	71	77	73	69	67	
3	89	78	69	63	86	76	68	62	73	66	61	70	64	60	67	62	58	56	
4	81	69	60	53	79	67	59	52	65	57	51	62	56	51	60	54	50	48	
5	74	61	52	45	72	60	51	45	58	50	44	56	49	44	54	48	43	41	
6	69	55	46	39	67	54	45	39	52	44	39	50	43	38	49	42	38	36	
7	64	50	41	35	62	49	40	34	47	40	34	46	39	34	44	38	33	31	
8	59	45	37	31	58	45	36	31	43	36	30	42	35	30	41	34	30	28	
9	55	42	33	28	54	41	33	27	40	32	27	39	32	27	37	31	27	25	
10	52	38	30	25	50	38	30	25	37	30	25	36	29	25	35	29	24	23	

RC - Ceiling Cavity Reflectance RW - Wall Reflectance

**22-OAT3D-LED-4000L-5000L-6000L-DIM10-120-347V-35K-40K-50K-85(6000L)**

TEST NO.: **EL10052034**

INPUT WATTS: **50.1**

LUMENS: **5694**

CRI: **N/A**

EFFICACY: **114**

CCT: **3500K**

SPACING CRITERIA: **1.42**

**Candle Power Distribution (Candelas)**

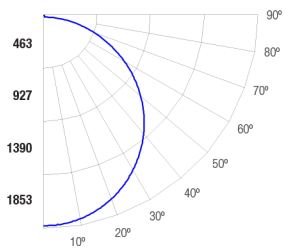

**Zonal Lumens Summary**

Zone	Lumens	%Lamp	%Fixt
0-20	675.71	11.90	11.90
0-30	1442.7	25.30	25.30
0-40	2380.54	41.80	41.80
0-60	4289.98	75.30	75.30
0-80	5479.56	96.20	96.20
0-90	5637.82	99.00	99.00

**Luminance (Average candela/M<sup>2</sup>)**

Angle in Degrees	Average			
	0°	45°	90°	
45	4860	4872	4880	
55	4777	4796	4816	
65	4638	4637	4657	
75	4426	4388	4405	
85	4206	4201	4335	

**Lumens Per Zone**

Zone	Lumens
0-10	174.29
10-20	501.42
20-30	766.99
30-40	937.84
40-50	991.15
50-60	918.29
60-70	733.04
70-80	456.54
80-90	158.26

**Candela Tabulation**

0	
0.0	1841.245
5.0	1836.170
15.0	1776.490
25.0	1662.800
35.0	1496.350
45.0	1278.260
55.0	1019.080
65.0	729.050
75.0	426.080
85.0	136.350
90.0	19.200

**Coefficients of Utilization - Zonal Cavity Method**  
Effective Floor Cavity Reflectance 0.20

RC	RW	80%				70%				50%			30%			10%			0%
		70%	50%	30%	10%	70%	50%	30%	10%	50%	30%	10%	50%	30%	10%	50%	30%	10%	0%
0	119	119	119	119	116	116	116	116	111	111	111	106	106	106	101	101	101	99	
1	108	103	98	94	105	100	96	92	96	92	89	92	89	86	88	86	84	81	
2	98	89	82	76	95	87	80	75	83	78	73	80	75	71	77	73	69	67	
3	89	78	69	63	86	76	68	62	73	66	61	70	64	59	67	62	58	56	
4	81	69	60	53	79	67	59	52	65	57	51	62	56	51	60	54	50	48	
5	74	61	52	45	72	60	51	45	58	50	44	56	49	44	54	48	43	41	
6	69	55	46	39	67	54	45	39	52	44	39	50	43	38	49	42	38	36	
7	64	50	41	35	62	49	40	34	47	40	34	46	39	34	44	38	33	31	
8	59	45	37																