

# Solo Sensor

## PIR Occupancy Sensing and Daylight Harvesting



### Description

The Solo Sensor (ZLS05) is a 0-10V dimming Passive Infrared (PIR) occupancy and daylight harvesting sensor designed to be installed directly into a light fixture for standalone lighting control. Configure output settings and dimming profile using DIP switches or access additional features using the ZLS0R remote control.

The ZLS05 integrates PIR occupancy sensing and photocell technology in a single compact unit. Install the ZLS05 into linear strip and pendant lighting, existing downlights, troffers and other general lighting fixtures for standalone control that complies with energy codes.

### Applications

- Luminaire level lighting control
- Occupancy and light level sensing
- 0-10V dimming
- Open offices
- Warehouses
- Manufacturing

### Features

- 0-10V dimming
- Occupancy sensing
- Daylight harvesting
- Partial-ON
- Partial-OFF
- IR remote configurable
- 8'-10' mounting height
- IP20 rated
- Can be used to comply IECC, ASHRAE 90.1 and 2019 Title 24, Part 6 dimming, occupancy/vacancy sensing and daylight harvesting requirements

### Field-of-View

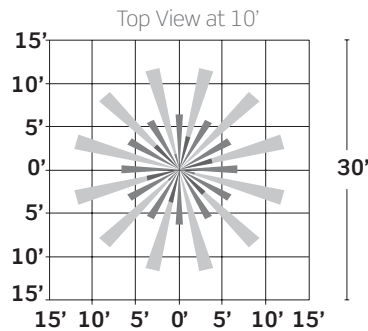

- Minor Motion
- Major Motion

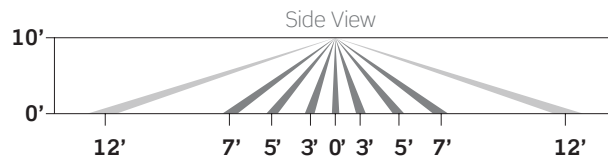

# Product Data

## ZLS05-ILW

### Dimensions Diagram

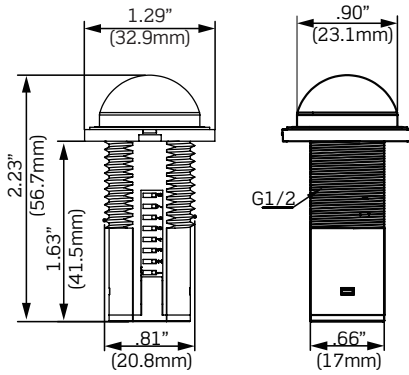

Front View

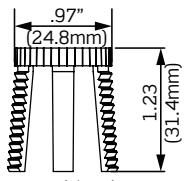

Side View

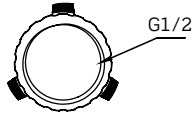

Top View

### Wiring Diagram

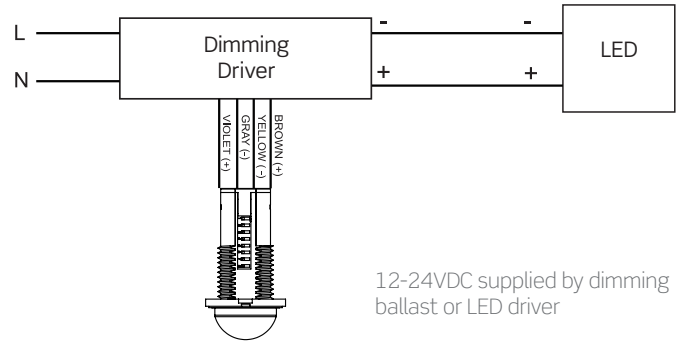

### Installation Requirements

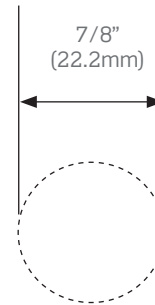

- 0-10V dim-to-OFF driver with AUX port power supply
- 7/8" diameter round punch hole in fixture - see diagram

### DIP Switch Settings

- Task Level**—set desired task level and the built-in daylight sensor will measure ambient light to determine how much artificial light is needed
- Occupied Time Out**—set desired time out period and the light will remain ON until the time out expires. Any motion in the space will restart the time out period.
- Standby Light Level (Partial-OFF)**—set desired standby level to dim lights after the occupied time out had expired
- Standby Time**—set desired standby time to keep lights at standby level until the time period expires or when motion is detected
- Default Settings**
  - Task Level: 100%
  - Occupied Time Out: 10 sec
  - Standby Light Level: 20%
  - Standby Time: 30 min

ON ↑  
OFF ↓

Task Light Level: 1, 2

Task Light Level		
1	2	%
↓	↓	70%
↓	↑	80%
↑	↓	90%
↑	↑	100%

ON ↑  
OFF ↓

Time: 3,4,5

Time			
3	4	5	
↓	↓	↓	10 seconds
↓	↓	↑	30 seconds
↓	↑	↑	1 minute
↓	↑	↑	3 minutes
↑	↓	↑	5 minutes
↑	↓	↑	10 minutes
↑	↑	↓	15 minutes
↑	↑	↑	30 minutes

ON ↑  
OFF ↓

Standby Level: 6

Standby Level	
6	%
↓	20%
↑	50%

ON ↑  
OFF ↓

Standby Time: 7,8

Standby Time		
7	8	
↓	↓	1 minute
↓	↑	30 minutes
↑	↓	60 minutes
↑	↑	+ ∞

### IR Remote Button Configurations

	<ul style="list-style-type: none"> <li>Enable/Disable Occupancy Sensor—Daylight Harvesting continues to operate if enabled</li> </ul>
	<ul style="list-style-type: none"> <li>Reset parameters to DIP switch settings</li> <li>Copy and repeat last parameters set</li> </ul>
	<ul style="list-style-type: none"> <li>Enable/Disable Daylight Harvesting—Occupancy Sensor continues to operate if enabled</li> </ul>
	<ul style="list-style-type: none"> <li>Set desired task level—Two additional levels: 50% and 60% available using IR remote</li> </ul>
	<ul style="list-style-type: none"> <li>Set desired occupied time out</li> </ul>
	<ul style="list-style-type: none"> <li>Set stand-by light level—Two additional levels: 0% and 10% available using IR remote</li> </ul>
	<ul style="list-style-type: none"> <li>Set stand-by prolonged time out</li> </ul>

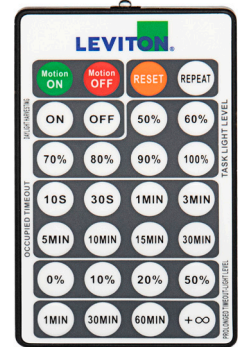

### Specifications

#### Electrical

Input Power	12V-24VDC, 50mA
Dim Control Output	0-10V, 30mA sinking
Cable Length	39.37" (1000mm)

#### Environmental

Operating Temperature Range	-4° to 158°F (-20° to 70°C)
-----------------------------	-----------------------------

#### Other

Mounting Height	8' to 10' (2.43m to 3.04m)
Detection Angle	120°
Energy Codes	Can be used to comply with IECC, ASHRAE 90.1 and 2019 Title 24, Part 6 dimming, occupancy/vacancy sensing and daylight harvesting requirements
Listings	cULus
Rating	IP20 Rated
Warranty	5-year Limited

### Ordering Information

#### Product Name

#### Cat. No.

#### Description

ZLS05-ILW	Solo PIR and Daylight Harvesting Sensor, fixture embedded. 12-24VDC input voltage, 30mA sinking. Mounting height 10ft max. Programmable via DIP Switches to adjust task level, time-out, standby level and time. Optional IR remote (Cat. No. ZLS0R-RA1) for additional control functionality. Requires 0-10V dim-to-off driver. Color: White.
ZLS0R-RA1	Optional Solo Sensor IR Remote

---

**Leviton Manufacturing Co., Inc. Lighting & Controls**

20497 SW Teton Avenue, Tualatin, OR 97062 **tel** 800-736-6682 **tech line** (6:00AM-4:00PM PT Mon-Fri) 800-959-6004

**Leviton Manufacturing Co., Inc. Global Headquarters**

201 North Service Road, Melville, NY 11747-3138 **tel** 800-323-8920 **tech line** (8:30AM-7:00PM ET Mon-Fri) 800-824-3005

**Visit our Website at: [www.leviton.com/intellect](http://www.leviton.com/intellect)**

©2021 Leviton Manufacturing Co., Inc. All rights reserved. Subject to change without notice.