



SAFETY INSTRUCTIONS

1. Equipment should be mounted securely in locations and at heights where it will not be readily subjected to tampering by unauthorized personnel. 2. Do not mount near gas or electric heaters. 3. Cap unused wires with enclosed wire nuts or other approved method. 4. Do not use this equipment for anything other than its intended use. 5. The use of accessory equipment not recommended by the manufacturer will void product listing and warranty and may cause an unsafe condition. 6. Any service on this equipment should be performed by qualified personnel only. 7. Make sure wire terminations are secure and leads are properly tucked in appropriate wire channels. 8. Damaged by corrosion will not be honored as a materials defect claim. It is the user's responsibility to provide suitable protection against corrosive agents such as moisture and condensation and other harmful elements. 9. Electrical connection should be in a dry area unless adequately sealed. **CONSULT A QUALIFIED ELECTRICIAN BEFORE INSTALLING**



Note:

1. This fixture should not be used in areas with limited ventilation or high ambient temperature exceeding 45°C. 2. Keep enough length wires to ensure adjusting angle unhindered. 3. This product series emits high light output. DO NOT look directly into the light emitting area. Direct exposure to the light over an extended time period may harm eyes 4. Operating ambient temperature range -40°C to 45°C



Caution:

Disconnect AC power before servicing and installation. All electrical connections must be in accordance with NEC/CEC or your local code.

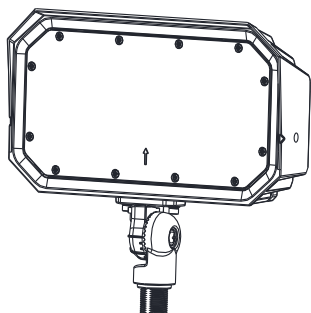

PRODUCT DIMENSIONS

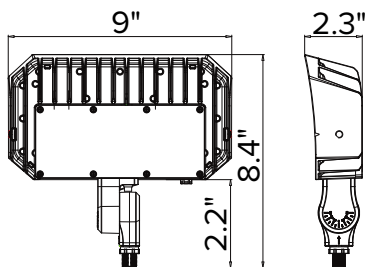

PRODUCT SPECIFICATION

Input Voltage	120-277 VAC
Input Current	0.459 A
Frequency	50/60 Hz
Rated Power	50W
Suitable For	Wet Location

INSTALLATION STEPS (KNUCKLE)

1.

Use screw key to open the junction-box

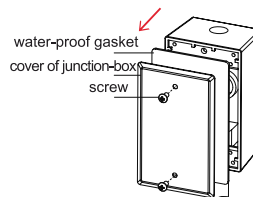

2.

Put the wires of lamp into the junction-box.

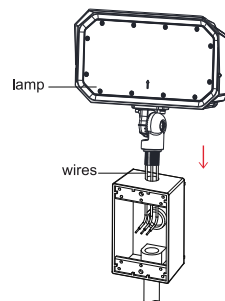

3.

Screw up the knuckle mount into junction-box.

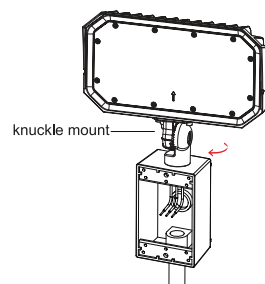

- 4.**
Use wire-nuts to connect the wires of lamp and junction-box

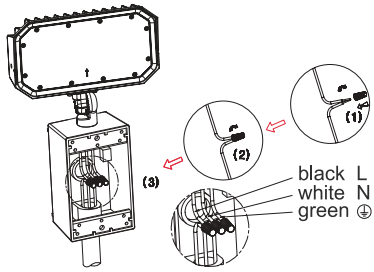

- 5.**
Lock the junction-box with screw key.

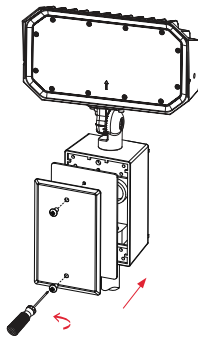

- 6.**
Use hex-key to screw off the hex-screw in knuckle mount.

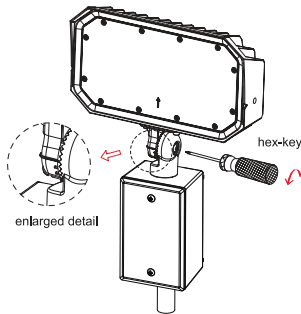

- 7.**
Adjust the lamp into suitable angle.

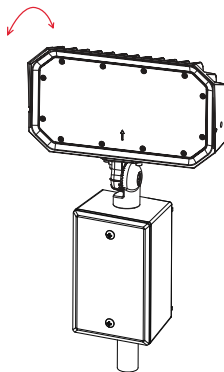

- 8.**
Use hex-key to screw up the hex-screw. Installation completed.

