

Installation Instructions

RECESSED

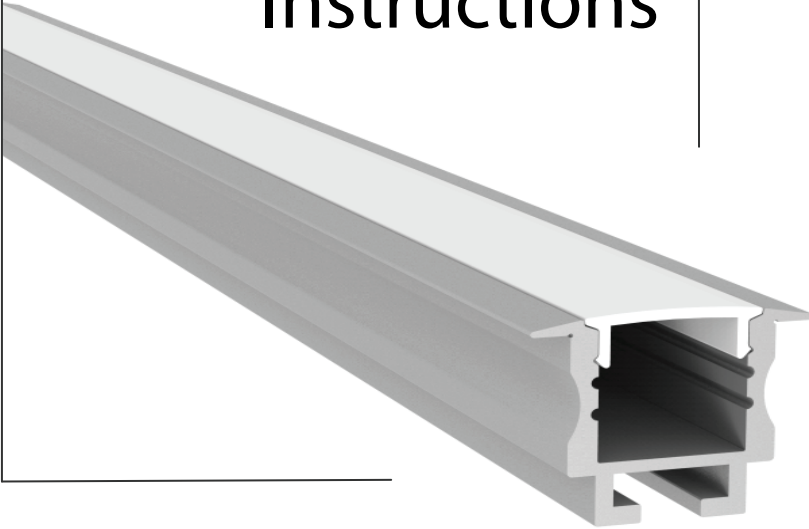

WARNING: Please review all instructions PRIOR to beginning installation.

- Professional installation by a licensed electrician is required.
- Always disconnect the power supply from the electrical circuit before commencing any work.
- Use exclusively with a Class 2 power supply unit.
- Input Voltage: 24VDC.

Required Tools



Screwdriver for removing the end caps
Screwdriver for attaching clips to the channel and surface.



Tape measure to determine the length of the LED strip before making any cuts.



Scissors for trimming the LED strip to the desired length.



Pliers to secure or close the connectors.

NOTE

These are the **basic tools for installing the LED strip inside the extrusion**. For **Recessed** option, you may also need a cordless drywall drill/driver, safety glasses, a staple gun, and **all the elements required for a safe installation**.

1



Cut out the **drywall or material** to the size of the extrusion to be **installed**.

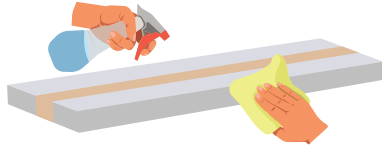

Ensure to **clean the dust and residues** left in the material.

2

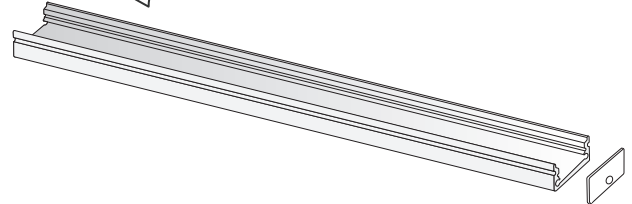

Make sure to **clean the extrusion** thoroughly before installing the LED Strip Light to **prevent** any surface irregularities.

3

The **LED wire** can be either ready-soldered to the LED strip light or installed **via connectors** supplied.

Refer to installation instruction number 8 for details.

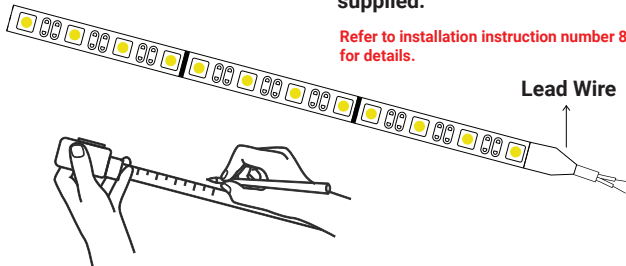

Measure the **LED Strip light** before cutting to ensure it will have the same length as the extrusion.

4

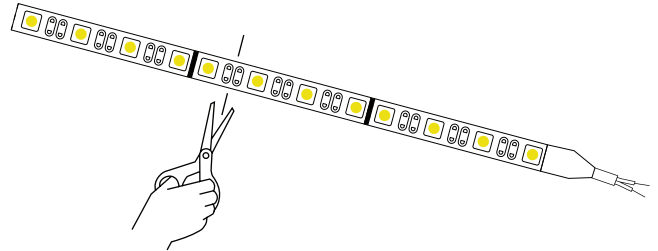

Cut the LED strip at the designated soldered spot.

The cutting length between designated spots may vary depending on the series you are installing.

5

Carefully remove the adhesive tape and proceed to **install the LED strip** inside the extrusion.

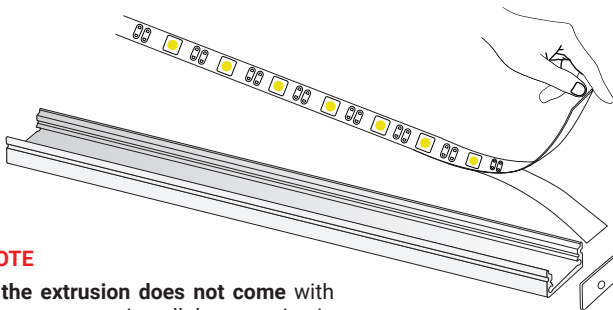

NOTE

If the extrusion does not come with clips, you must install the extrusion in the **designated area** using screws before installing the LED Strip Light.

6

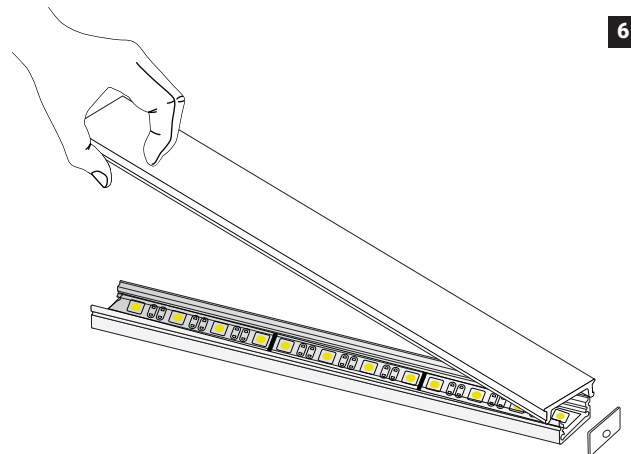

Once the **LED strip is installed**, proceed to install the lens, end caps, and clips if necessary.

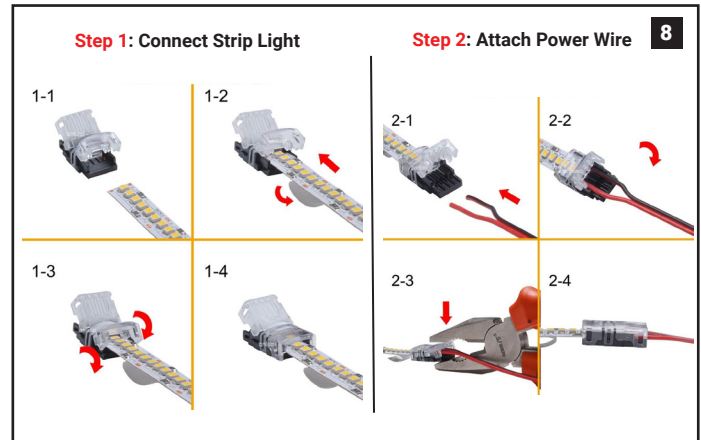
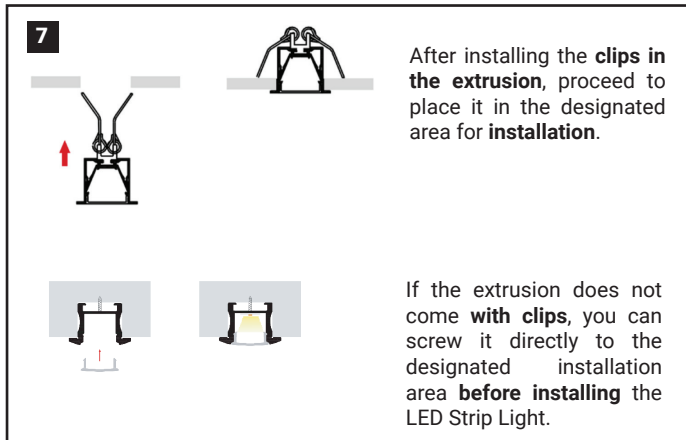

NOTE

Consider the following **comprehensive guide** to supplement the installation process. This **step-by-step manual** furnishes clear instructions to guarantee a smooth and successful installation of your **LED strip**.

For additional details, please contact the factory.

**Architectural LED Strip
Tape installation in channel**

1.0 Warning

- 1.1 LED strips must be installed indoors only. Installing outdoors will void the warranty.
- 1.2 . Installation must be carried out by a licensed electrician & executed in accordance with local codes.
- 1.3 . The customer assumes all liability for the safety and code compliance of the installation.
- 1.4 Elite Lighting is not liable for damages caused by improper wiring, driver overloading, driver under-loading, power surges, or negligence.

2.0 LED Strip Installation

- 2.1 Test fit the LED Strip into channel to ensure it is the proper length.
 - 2.1.1 This can be more easily facilitated with two people.
 - 2.1.2 If unsure use painters' tape to temporarily install LED Strip
- 2.2 Clean out any debris or dust that has settled in the sides of the channel.
- 2.3 LED strip may not properly adhere to channel surface unless the channel is cleaned with alcohol prior to application. Do not use mineral spirits or other products containing petroleum products.**
- 2.4 If unsure about dust or debris, apply contractor's tape in channel to check for adhesion.
- 2.5 Start with the powered side of the LED Strip and the powered side of the Channel.
 - 2.5.1 Be sure the LED Strip lead is passed through the end cap if supplied.
 - 2.5.1.1 Carefully remove the backing about 1" from the end of the LED Strip making sure not to remove the tape from the LED Strip
 - 2.5.1.2 Firmly press the adhesive back of the LED Strip onto the channel surface
 - 2.5.2 Install the rest of the LED Strip
 - 2.5.2.1 Carefully remove the backing about from the LED Strip making sure not to remove the tape from the LED Strip
 - 2.5.2.2 Firmly press the adhesive back of the LED Strip onto the channel surface
 - 2.5.2.3 Remove the backing slowly and methodically.
 - 2.5.2.4 Make sure there are no air bubbles.
 - 2.5.2.5 Be sure the LED Strip is straight and parallel to the channel opening.
 - 2.5.2.6 Keep affixing the LED Strip until you get to the end of the channel.
- 2.6 Check fit of installed tape.
 - 2.6.1 The entire length of the channel should be covered with LED Strip
 - 2.6.2 Center strip to get desired luminous effect.