

INSTALLATION INSTRUCTIONS

2-Hours Fire Rated IC Airtight New Construction LED Housing

INSTALL AND USE THIS PRODUCT FOLLOWING YOUR LOCAL ELECTRICAL CODES AND REGULATIONS

CAUTION:
CONSULT A QUALIFIED ELECTRICIAN BEFORE INSTALLING FIXTURE

PREPARATION:

1. Read the instructions carefully before installing this fixture. If you are unfamiliar with electrical wiring. Have a qualified licensed electrician install this fixture for you
2. Before proceeding be sure the ceiling construction follows the requirements shown in (FIG.A)
3. Shut off electrical power at the fuse or circuit breaker panel.
4. Properly position a sturdy and stable step ladder high enough to reach the ceiling safely.

BAR HANGERS:

1. Install hanger bars to fixture-be sure end tab is facing outward.(Fig.B)

INSTALLING FIXTURE TO CEILING:

1. Joists type ceilings-Extend bar hangers to fit between joist and position fixture temporarily by hammering nail on bars into the joists Hangers should be leveled with bottom of joists(Fig.C)
2. Suspended(T-bar)ceilings-Extend barhangers 1"past T-bars then rest fixture on t-bars. Secure fixture to t-bars with wire see(Fig.D)

INSTALL TRIM ASSEMBLIES:

Insert trim into housing -Push upward fully and pressure springs will hold trim in place.(Fig.E)

ELECTRICAL CONNECTION:

1. Most dwellings built before 1985 have supply wire rated 60°C.
 2. Junction box contains three wires, a black(hot +) white(neutral-)and bare ground.
- MAKE SURE TO CONNECT WHITE TO WHITE AND COLORED OR BLACK TO BLACK(Fig.F)**
3. After completing the wiring.(being sure the wires are placed within wiringbox).snap wiring box cover closed.
- See Fig.G for low voltage.

Grounding:

For Romex or 3 wire BX, flexible Armour cable installations attach supply ground lead to bare copper ground lead or ground screw in wiring box mount or mounted on plaster frame. Local electrical codes should be consulted to determine acceptable installation-conduit Romex, or flexible Armour cable.

AIR-TIGHT-INSTALLATION INSTRUCTIONS

After installing the housing in the ceiling. Seal opening of ceiling and around the edge of plaster frame by gasket supplied in J-box. Then put lamp and trim into the fixture.

Fig .A

Non-IC Housing:
Insulation must not be used in direct contact with fixture. Insulation needs to be at least 3"away from the fixture.

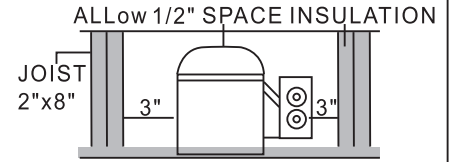

IC Housing:
Can be installed in direct contact with insulation.

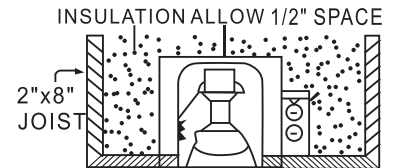

1/2"TO 1"THICK CEILING MATERIAL

Fig.B

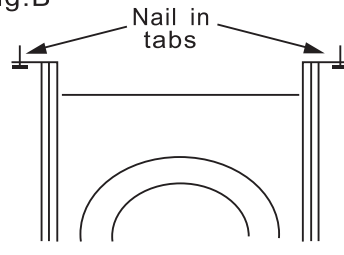

Fig.C

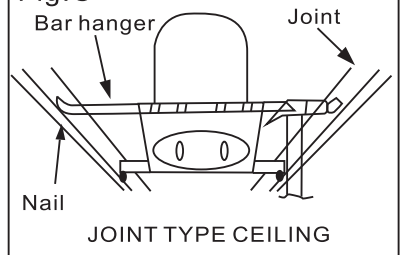

Fig. D

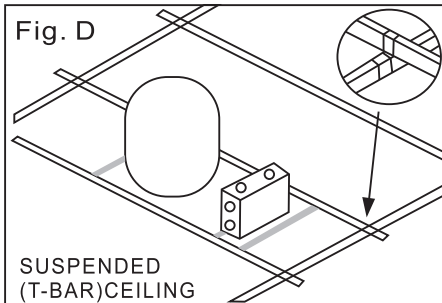

Fig. E

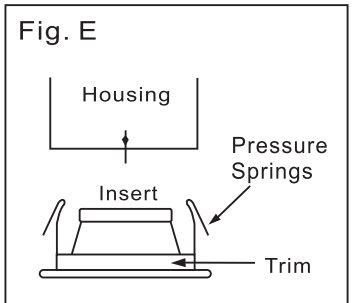
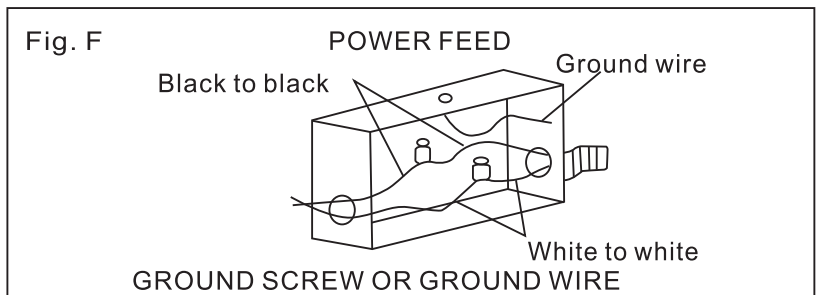
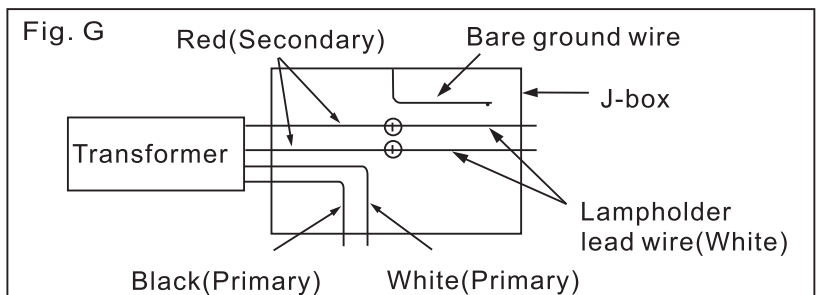

Fig. F



Wiring Connection in J-box for low voltage

Fig. G



INSTALLATION INSTRUCTIONS

2-Hours Fire Rated IC Airtight New Construction LED Housing

1. BAR HANGERS

Insert bar hangers into the slots on the plaster frame (Fig 1)
Position bar hangers so that nail in tabs point away from housing or point down to ceiling.

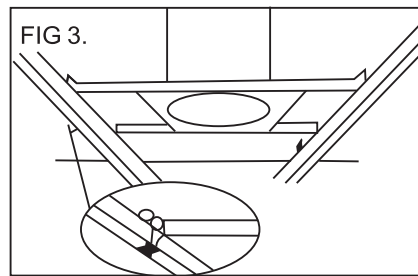
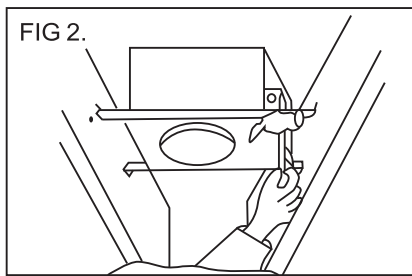
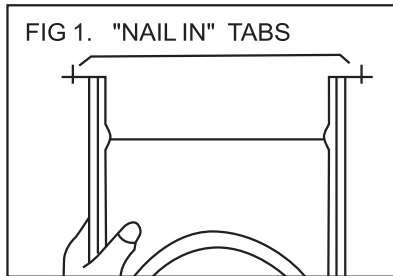

2. FASTENING FIXTURE TO CEILING

Joist-type ceilings-Extend bar hangers to fit between joists. Position fixture temporarily by hammering "nail-in" tabs into joists (Fig 2) then secure permanently with nails. Hangers should be level with bottom of joists.
Suspended (T-bar) Ceilings-extend bar hangers 1" past T-bars then rest fixture on T-bars. Secure fixture to T-bars with wire see Fig 3

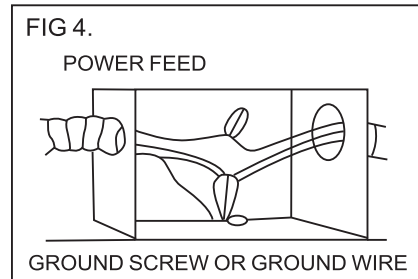

3. ELECTRICAL CONNECTION

Junction box contains two wires, a black (hot +) and a white (neutral-) which must be spliced to the house current feed wires. Make sure to splice white to white and colored or black to black. After splicing has been completed, tuck splices carefully into junction box and replace cover (Fig 4)

Grounding

For Romex or 3 wire Bx, flexible Armour cable installations attach supply ground lead (green) to bars copper ground lead or ground screw in wiring box mount or mounted on plaster frame. Local electrical codes should be consulted to determine acceptable installation-conduit Romex or flexible Armour cable.



4. CUTTING A HOLE

Locate the center of proposed opening on your tile or ceiling material and mark it round. Use a compass to draw a circle 4-1/2" (4inch housing FIG 5.) or 6-3/8" (6inch housing FIG 6.) in diameter around the center point, cut along this circular line.

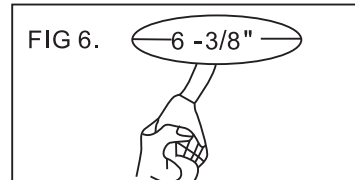

HOW TO ACCESS THE JUNCTION BOX

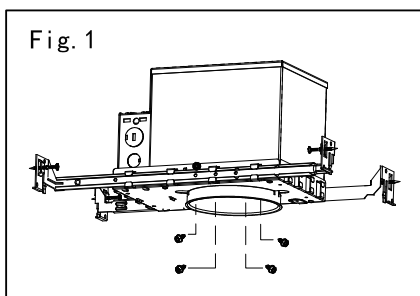

Step1. Remove the screws

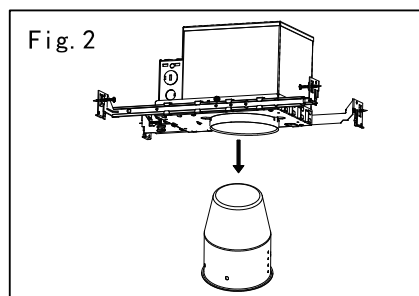

Step2. Remove the wire protectors, take out the can

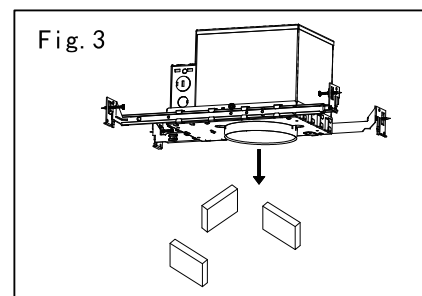

Step3. Take out the cottons which are near the j-box

WARNING-RISK OF FIRE. MOST DWELLINGS BUILT BEFORE 1985 HAVE SUPPLY WIRE RATED 60°C. CONSULT A QUALIFIED ELECTRICIAN BEFORE INSTALLING.

Suitable for insulated ceilings for total contact covered with insulation.

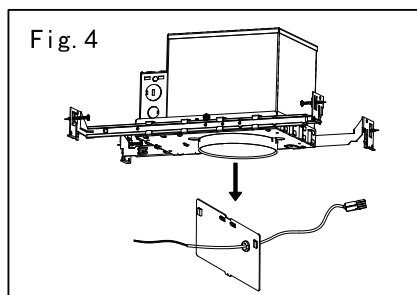

Step4. Remove the J-box cover and the wires

