

SURFACE MOUNT LED EXIT SIGN

EMERGENCY BATTERY BACKUP

INSTALLATION & OPERATION INSTRUCTIONS

Package Contents

Part	Description	Quantity
1	LED Edge-Lit EXIT Sign	1
2	Canopy	1
3	Hardware Bag	1

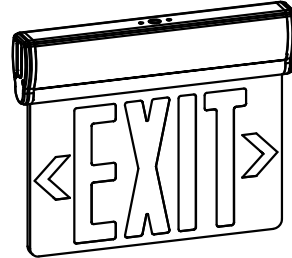

Warnings and Cautions

IMPORTANT SAFEGUARDS

READ AND FOLLOW ALL SAFETY INSTRUCTIONS.

When using electrical equipment, basic safety precautions should always be followed including the following

1. All servicings should be performed by a qualified personnel only.
2. Before starting the installation, disconnect the power by turning off the circuit breaker or by removing the appropriate fuse at the fuse box. Using the light switch to turning the power off is not sufficient to prevent electrical shock.
3. Do not use outdoors.
4. Do not mount near gas or electric heaters.
5. Use caution when servicing batteries. Battery acid can cause burns to skin and eyes. If acid is spilled on skin or eyes, flush acid with fresh water and contact a physician immediately.
6. Equipment should be mounted in locations and at heights where it will not be subjected to tampering by unauthorized personnel.
7. The use of accessory equipment not recommended by the manufacturer may cause an unsafe condition.
8. Do not use this equipment for other than its intended use.
9. Allow battery to charge for 24 hours before first use.

SAVE THESE INSTRUCTIONS

ELECTRICAL CONNECTIONS

- Make the proper supply wire connections.
- If using 120VAC, connect the black and white wires to the building utility.
- If using 277VAC, connect the orange and white wires to the building utility.
- Cap off unused wires. In all cases, use standard wire nuts to connection to wires.

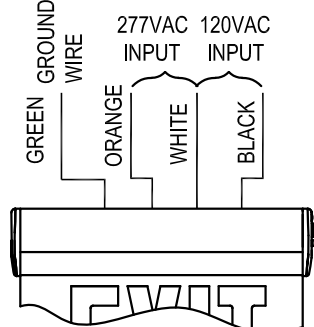

DETERMINE DIRECTION

- If need indicator, remain indicator and remove instruction film.
- If no need indicator, remove indicator and instruction film together.



Mounting Instructions

NOTE: First turn off electricity.

Surface Ceiling & Wall Mounting

1. Attach crossbar to junction box.(TM8#-32*-1)
2. Use screwdriver open front cover to connect battery connector.

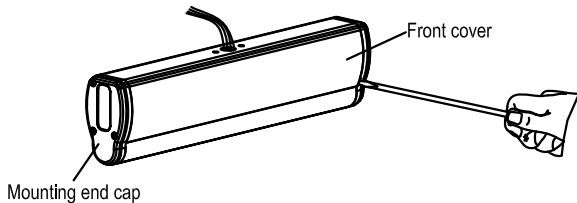

3. Feed AC supply wires through canopy center hole.
4. Assemble canopy onto main body assembly with (2) PM4*12 screws(supplied) and make proper wire connections.
(See ELECTRICAL CONNECTIONS).
5. Use (2) PM4-40 screws (supplied) tighten canopy to crossbar.

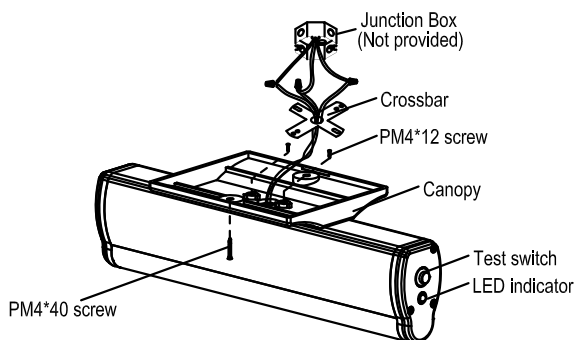

6. Peel off protection film from EXIT panel, insert EXIT panel into main body assembly gently. If EXIT panel is for single face, make sure EXIT letter direction is correct.

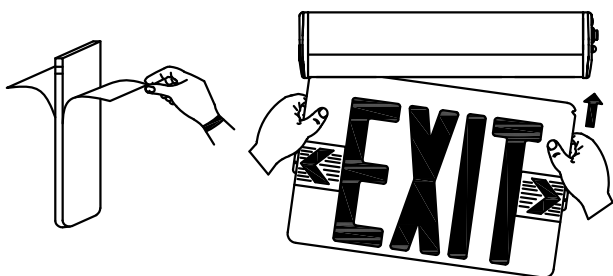

7. Determine direction for chevron placement.
(See DETERMINE DIRECTION)

8. The unit can be installed on any surface, you may rotate the EXIT panel in any angle from 0° to 180°, Ceiling mounting rotate 90° become Wall mounting.

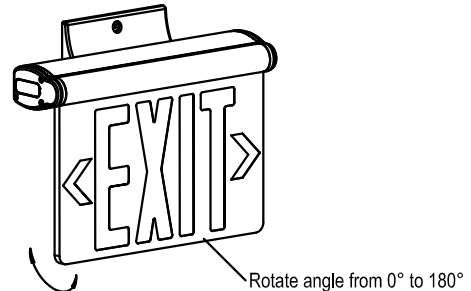

Surface Side Mounting

1. Attach crossbar to junction box.
2. Use screwdriver open front cover to connect battery connector.
3. Remove the hole plug from mounting end cap.
4. Pull out all AC supply wires and feed wires thru the center holes of mounting end cap and then canopy.
5. Reference 4 - 8 step in surface ceiling & wall mounting above for surface end mounting.

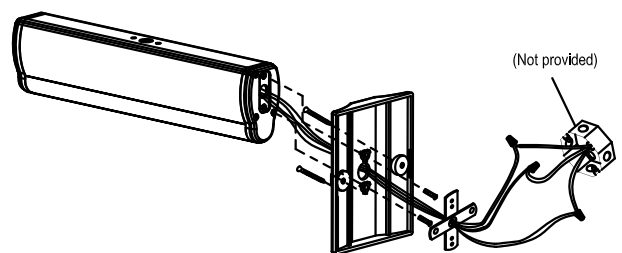

MAINTENANCE

Battery have to recharge if product keep in stock over 9 months, detail manual refer "BATTERY STOCK AND RECHARGE GUIDELINE". We recommend that the equipment be tested regularly in accordance with local codes. Replace the batteries as needed if discharge time do not achieve 90 minutes,

OPERATION

Press the test button, unit illuminance by battery backup and the LED indicator will turn off, release the test switch, LED indicator will turn on and the LED heads will turn off.

TROUBLE SHOOTING GUIDE

If LED heads or LED indicator does not illuminate, check the following:

1. Check AC supply - verify that unit has 24 hours AC supply.
2. Battery connection.
3. Discharge battery and charge battery for 24 hours and then retest.
4. If above trouble shooting hints do not solve the problem, contact factory for assistance.